

PERKO®

WE MAKE IT RIGHT. RIGHT HERE.

CATALOG NO. 270

1992 - 1993



THE DIFFERENCE IS DISTINCTIVE®

DISPLAY PACKAGING PROGRAM

Since the publication of our last catalog, we have greatly increased the number of products available in display package form. These attractive packages now make PERKO products easier to sell . . . and easier for the customer to buy.

Our commitment to better dealer/distributor sales and profits is backed by our continuing program of service and support. It's a PERKO PLUS!

As you look through this catalog you will find symbols next to those products that are Display Packed. The five styles of display packaging are illustrated below.



SKIN PACK



BAG

NEW



BLISTER PACK



BUBBLE PACK



BOX

PERKO®

WE MAKE IT RIGHT, RIGHT HERE . . .

CATALOG NO. 270 1992-1993

Street Address
16490 Northwest 13th Avenue
Miami, Florida 33169-5707

Mailing Address
P.O. Box 64000
Miami, Florida 33164-0510

Telephone Number
(305) 621-7525

Fax Number
(305) 620-9978

© PERKO, INC. 1992
ALL RIGHTS RESERVED

PORTIONS OF THIS CATALOG
PREVIOUSLY COPYRIGHTED IN
1936-1990 INCLUSIVE

THE DIFFERENCE IS DISTINCTIVE®

MANUFACTURER OF
SHIP AND BOAT EQUIPMENT

**NAVIGATION LIGHTS FOR
VESSELS UNDER 20 METERS**
1-38

**NAVIGATION LIGHTS FOR
VESSELS OVER 20 METERS**
39-48

SEARCHLIGHTS
49-64

**ELECTRIC SWITCHES
LIGHTING FIXTURES
BULBS**
65-84

**VENTILATORS
VENTS, BELLS**
85-92

**PIPE & HOSE DECK PLATES
UNDERWATER FITTINGS
STRAINERS, FILTERS**
93-112

**DECK HARDWARE, CLEATS
CHOCKS, BITS, BOW EYES
ROWLOCKS, WINDSHIELD &
HATCH ADJUSTERS**
115-148

**CABINET & DOOR
HARDWARE, LOCKS
HINGES, HOOKS, ETC.**
149-180

**FISHING
EQUIPMENT**
181-192

PERKO, INC.

16490 N.W. 13th AVENUE
MIAMI, FL 33169-5707

MAIL: P.O. BOX 64000-D
MIAMI, FL 33164-0510

PHONE: (305) 621-7525
FAX: (305) 620-9978

MARVIN S. PERKINS
PRESIDENT

To Our Friends:

It is with a great deal of pleasure that we present this 1992-93 edition of your PERKO Catalog. You will note any new products and many products added to our Display Package Program.

In total, I think you will agree, "The difference is distinctive®" ... as are all PERKO products.

Since the late 1800s, we have been manufacturing marine lights, hardware and accessories in our factories, to exacting standards of quality and performance. In fact, our **made in U.S.A.** products have become the world standard for premium quality and performance in the marine industry ... we make it right, right here.

All PERKO products are designed to retain their original appearance and characteristics over long use, and carry a limited one-year warranty. In addition, any product finished with our exclusive PERKOPLATE chromium plating process or PERKO•KOTE powder coating process carries a lifetime warranty insuring the original finish for as long as the initial consumer-purchaser owns it. (See complete warranty, page XII.)

As you look over this catalog, feel free to call on us with any questions you may have. Our entire staff is dedicated to providing you, our customers, with service and performance for what you need, when you need it.

You can count on our commitment to excellence ... it's a PERKO plus!

Sincerely,

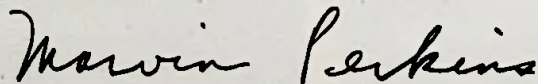

Marvin Perkins
President

MANUFACTURER OF MARINE LIGHTS, HARDWARE AND ACCESSORIES

The Perko Story

The PERKO story is really many interesting pieces that make up a modern day marine hardware success story . . . going back over 100 years!

Started by Frederick Perkins in a small plant in lower Manhattan, New York in the late 1880s, four generations later PERKO is still a privately owned, family operated corporation . . . very unusual for a company our size in today's marketplace. Now housed in a modern facility of over 300,000 square feet in North Miami, Florida, family control allows us to quickly respond to customer and market needs, and our business philosophy has always emphasized long term commitment to quality leadership in the marine industry.

Our employees are an integral part of our business family, and they take personal pride in providing individual attention to what they do, and how they do it. Their friendly, positive attitude is in part based on the fact that no piece work is performed in any of our operations. All employees are paid on an hourly basis . . . which eliminates a great deal of pressure, and also allows each worker the time to properly inspect PERKO products as they are being produced. Everyone concentrates on customer satisfaction.

The company Frederick Perkins started was known as Perkins Marine Lamp, Inc., and the original focus was on the manufacture of hand formed sheet metal products for the marine market. These ship navigation lights, cowl ventilators, chart cases and other hand formed items fabricated from brass, copper and galvanized sheet metal began what was to become our ongoing reputation for high quality products. Today, we still do hand forming and soldering much as it was done in our early years.

In 1907, Louis Perkins joined his



FREDERICK PERKINS



LOUIS E. PERKINS

Co-founders

father in the business, and together they enlarged both the line of products and the facilities to house the expansion. By 1932, the company name was changed to Perkins Marine Lamp and Hardware Corporation, to better reflect what was then being offered.

In 1922, the "PERKO" trademark was instituted. Each new product, and there were many, utilized the latest sophisticated metal manufacturing technology, and customers came to expect the highest standards of excellence from PERKO products.

As our reputation increased, the company enjoyed exceptional growth into the 1930s, and new manufacturing facilities were added. Under the direction of Lou Perkins, the original one story plant grew to five stories, and then to six more buildings. By the time Frederick Perkins died in 1947, PERKO had become a major factor in the fast growing marine industry.

At Frederick's passing, Louis Perkins became president. His son, Marvin, now president of PERKO, joined the company in 1947. With the passing of Louis Perkins in 1964, Marvin assumed the top

responsibilities and continued the growth and innovation that exists to this day.

Fred Perkins, Marvin's older son, entered the family business in the late 1960s, and quickly established himself as one of the marine industry's most knowledgeable authorities on navigational light requirements. Marvin's younger son, David Perkins, officially joined PERKO in 1981, and his considerable people skills have been a real asset to the company as sales/service coordinator.

Roy Hollenbeck came on board in 1960 to plan and coordinate the company move from Brooklyn, N.Y. to North Miami, Florida, which took place in 1961. Roy's extensive experience in manufacturing, plating, engineering, designing and production was instrumental in our successful move from a number of separate plants in N.Y. to one large plant with all of our facilities under one roof.

Today, PERKO is truly an integrated manufacturer, almost completely independent of outside vendors, with the exception of a few basic items such as light bulbs, electric wire, etc. A whole range of

complete in-house capabilities, from product design through manufacturing and assembly of finished products, enabled us to eliminate most subcontractors and obtain better control of our product quality, cost and delivery.

Throughout all of our operations, steps have been taken to efficiently assure production of the highest quality products. Our products are designed and manufactured to meet or exceed UL, NMMA, IM-MCO and other industry standards . . . and our own quality specifications. Quality control is consistently maintained and every step forward, from our founding to the present day, has been undertaken with our customer in mind. Each PERKO product is thoroughly evaluated for safety, appearance and function.

Once we were settled in Florida, in 1961, we established our own bronze factory. By 1965, a 47,000 square foot extension was completed to house the sophisticated die-casting systems that now produces zinc and bronze parts.

PERKO is the only **marine manufacturer** producing die-cast bronze parts . . . which are well

known for strength, uniformity, and high quality. As the 1960s ended, PERKO introduced pressure cast bronze hardware to the marine industry . . . another first.

Our sand casting foundries help us control the production of our high quality brass, bronze and aluminum castings, and offers assurance that the proper alloy is used for each job.

Our diverse press department utilizes a variety of forming tools, including multi-stage progressive tooling produced in our toolroom. Our large, conventional machine shop includes many secondary operations such as drilling, tapping and assembly. A separate machine shop houses a number of modern high speed automatic chuckers for high volume items, and our three separate polishing divisions assure the correct finishing procedure for each product.

Over the last two years, our plating plant has been completely redesigned and rebuilt into a state-of-the-art facility. Special automated controls insure the complete seven-strike chromium plating process which makes it possible to offer a

lifetime warranty on our well known PERKOPLATE finish.

In 1979, a 35,000 square foot plastics injection molding facility was added to enable us to produce all of our own plastic products and components for electric sockets, lenses, etc.

We have a number of IBM computers, one of which is coupled with scanning devices to control inventory and shipments against orders. Our in-house printing and graphics department produces almost all of our printed materials . . . from labels to sales bulletins. In total, careful planning over the years has enabled us to become virtually self-sufficient in every department.

It has always been our objective to provide our customers with the very best in marine lights, hardware and accessories at competitive prices. The marketplace has rewarded our emphasis on quality with ever increasing sales and reputation. Designed and built to the highest specifications, all PERKO products are backed with outstanding warranties and our commitment to excellence. It's a PERKO plus you can count on!

OUR MODERN SELF-CONTAINED FACILITY



General Information

SALES POLICY

PERKO Products are sold through our established Distributors. We do not sell direct to the public or organizations. Therefore, possession of this catalog does not infer an offer to sell. Please contact your local marine supplier.

PRICES AND TERMS

Our costs are subject to change due to causes beyond our control. Therefore, our price list is only intended for the guidance of our customers and does not necessarily establish resale prices. Applicable governmental regulations, shipping costs and other complications should be considered in arriving at a fair price. *A Repackaging Service Charge of \$5.00 net will apply to all broken packages.* All prices are subject to change without notice. Terms are 2% 10th Prox., net 30 days.

Orders from firms unknown to us and having no satisfactory commercial credit rating must be accompanied by cash or satisfactory references. C.O.D. shipments will be made if a 25% deposit is sent with order. Cash discounts do not apply to C.O.D. shipments.

ONE YEAR LIMITED WARRANTY

PERKO, INC. (PERKO) warrants to the original consumer-purchaser that PERKO's consumer products will be free from defective materials or workmanship, under normal use and service, for a period of one (1) year from the original purchase date.

ALL IMPLIED WARRANTIES, INCLUDING MERCHANTABILITY, ARE ALSO LIMITED IN DURATION TO THE ONE YEAR PERIOD FROM THE ORIGINAL PURCHASE DATE. PERKO SHALL NOT BE LIABLE FOR LOSS OF USE OF ANY OF ITS CONSUMER PRODUCTS, NOR SHALL PERKO BE LIABLE FOR OTHER INCIDENTAL OR CONSEQUENTIAL COSTS, EXPENSES, OR DAMAGES INCURRED BY THE ORIGINAL CONSUMER-PURCHASER OR BY ANY OTHER PERSON, FIRM OR CORPORATION.

SOME STATES DO NOT ALLOW LIMITATIONS ON HOW LONG AN IMPLIED WARRANTY LASTS, SO THE ABOVE LIMITATION MAY OR MAY NOT APPLY TO YOU. SOME STATES DO NOT ALLOW THE EXCLUSION OR LIMITATION OF INCIDENTAL OR CONSEQUENTIAL DAMAGES, SO THE ABOVE LIMITATION OR EXCLUSION MAY NOT APPLY TO YOU.

This Warranty is void if the consumer product warranted has been damaged by accident or unreasonable use, neglect, improper service or other cause not arising out of defects in material or workmanship. Excluded from this Warranty are Electric light bulbs (Lamps), Sealed Beam Units, and Fuses.

During the warranty period, your PERKO product will either be repaired or it will be replaced with a like product (at PERKO's option) without charge to the original consumer-purchaser, when returned prepaid and insured, with proof-of-purchase date to PERKO at our factory in Miami, FL. In the event of replacement, the replacement product will continue the warranty of the original product, or ninety (90) days, whichever is longer. **IMPORTANT: FOR THIS WARRANTY TO BE EFFECTIVE PERKO MUST BE SUPPLIED WITH PROOF-OF-PURCHASE DATE OF THE PRODUCT.**

PERKO does not authorize any person or company to create for it any other obligation or liability in connection with any of its products.

This warranty gives you specific legal rights, and you may also have other rights which vary from state to state.

DESIGNS

For the purpose of constant improvement in our products, the designs and specifications are subject to change without notice.

RETURN GOODS

Material made to order is not returnable. Stock material is only

returnable when permission has been granted by us, and is subject to a handling and refinishing charge. Shipping charges must be prepaid. Be sure to give date and number of invoice. Permission must be requested within 30 days after receipt of material.

WEIGHTS

The weights given in this catalog are approximate, but should be sufficient for general purposes.

SHIPPING INSTRUCTIONS

Customers should send specific shipping instructions; if this is not done, we will use our own judgment in selecting route.

SHIPMENTS

F.O.B. OUR PLANT, MIAMI, FLORIDA, unless quoted otherwise. We are not responsible for damage, loss or delay after goods are delivered to carrier. When loss or delay occurs, we will gladly assist in tracing or expediting, but such assistance is no criterion of responsibility.

When there is LOSS OR APPARENT VISIBLE DAMAGE to a shipment, when tendered for delivery, DO NOT give the carrier a clear receipt. Note such damage on the carrier's delivery receipt and HAVE THE DRIVER SIGN THE RECEIPT.

CONCEALED DAMAGE OR LOSS

1. Advise the delivering carrier in writing as soon as discovered or at least no more than 15 days after delivery, and request carrier to make an inspection.
2. RETAIN for the carrier's inspection, the CONTAINER and ALL PACKING that the damaged or lost material was packaged in.
3. SHORTAGES — Must be reported to us within 15 days after receipt of goods.

Modern Facilities

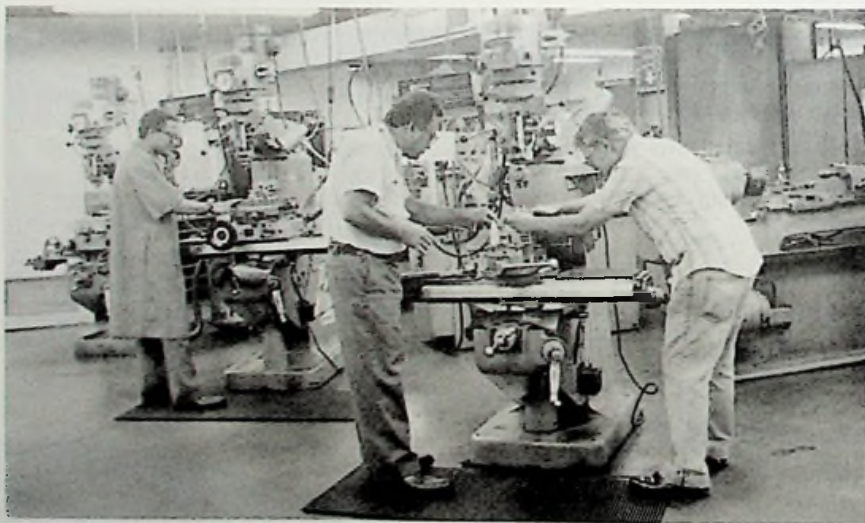
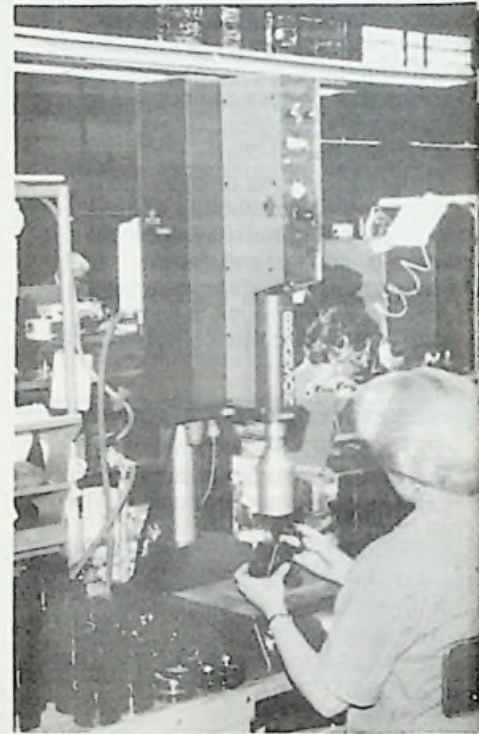
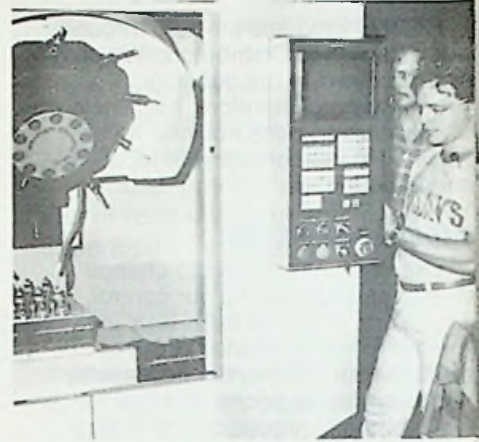
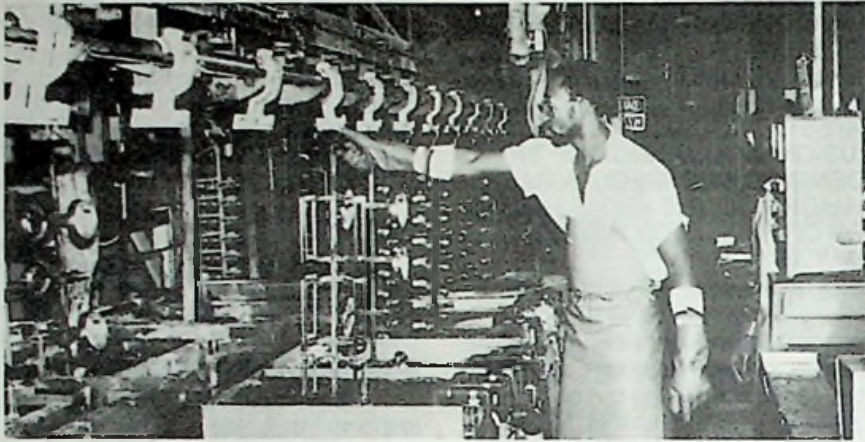

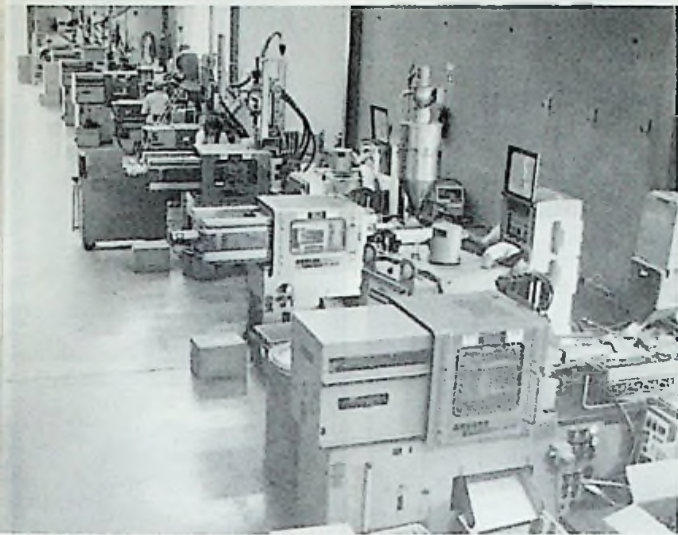

Top Left — PERKOPLATE Plating Department
Center Left — Quality Control Lab, Atomic Absorption Apparatus
Bottom Left — Tool and Die Department

Top Center — New Computerized CNC Machining Center
Bottom Center — Ultrasonic Bonding of Navigation Light Lenses

Top Right — Plastic Injection Molding Department
Bottom Right — Searchlight Department

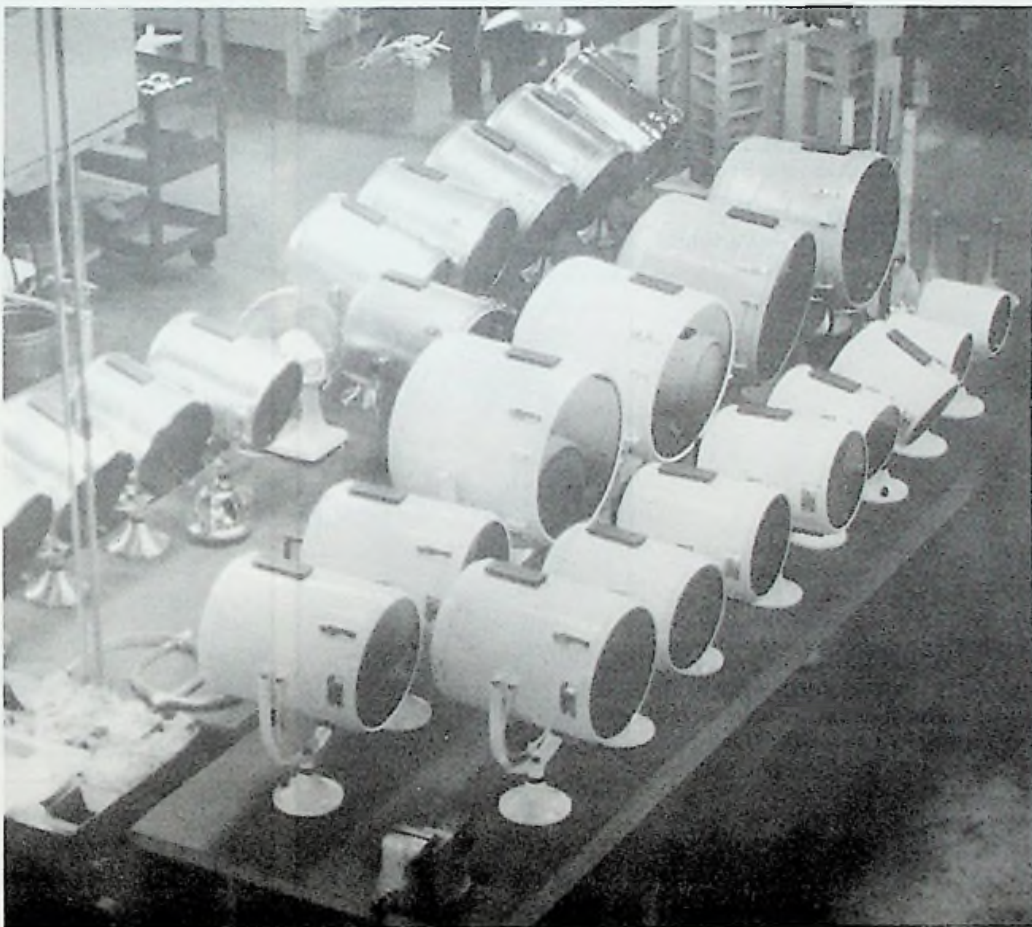

Our People

Officers

(L) MARVIN S. PERKINS
President

(R) LEROY S. HOLLENBECK
Executive Vice President



(L) FREDERICK M. PERKINS
Corporate Secretary

(R) ALLEN W. MATTHEWS, JR.
Vice President — Marketing



(L) JOHN P. RUSH
Asst. Vice President — Marketing

(R) K. TIMOTHY LePAGE
Vice President — Purchasing



(L) MIKE ANGELONE
Vice President — Data Processing

(R) ALBERT M. FREMONT
Treasurer



Staff



(L) REGINALD ULLMANN
Sales Mgr. — OEM Division



(R) JENI BEDRAN
Credit Manager



(L) LINDA SYKES
Customer Service



(R) ARTHUR KEYE
Customer Service — OEM Division



(L) GAIL MALLY
Customer Service



(R) CARLENE THOMSON
Customer Service

Export Division



(L) JOSE R. MARTINEZ
Sales Mgr. — Export Division



(C) ROSA SALAZAR
Export Service



(R) KEITH W. HEWITT
Exclusive European Sales Agent
Penvic Marine Limited
32 Copperfields — Totton
Southampton Hampshire SO42FL
England
Tele: (44) 703 870341
Fax: (44) 703 663156

REGIONAL SALES REPRESENTATIVES

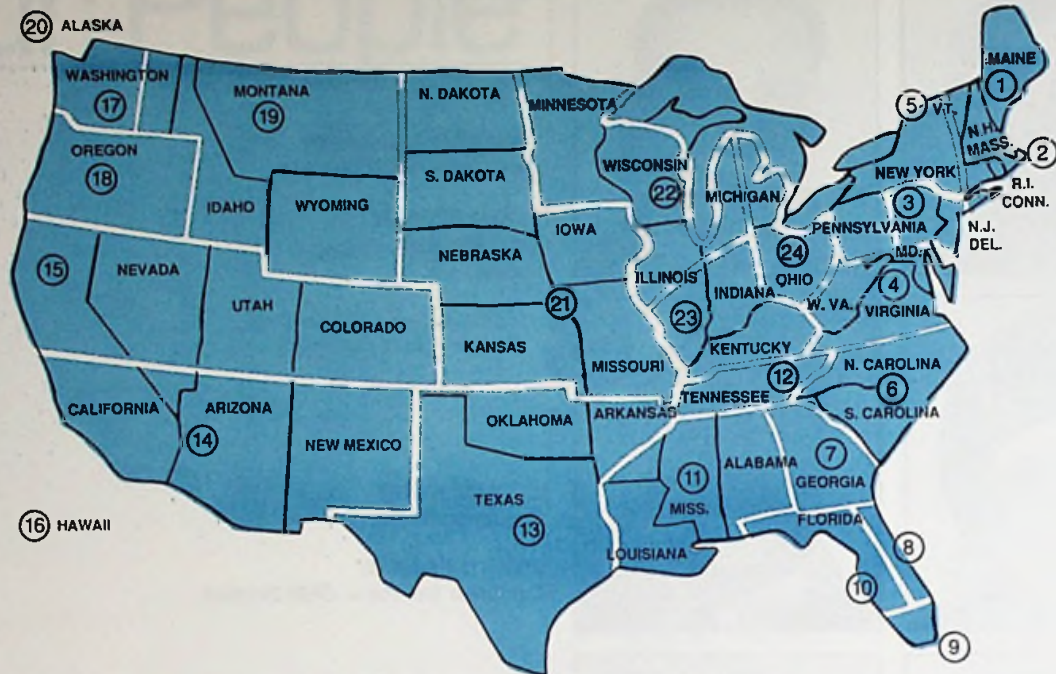

(1) MAINE, NO. MASS., NEW HAMPSHIRE, CONNECTICUT, VERMONT
 Carswell, Gallagher, Williams Associates
 354 Country Way/P.O. Box 414
 Scituate, MA 02066
 Phone 617-545-3790/Fax 617-545-0359
CHARLES W. O'CONNOR



(6) NORTH & SOUTH CAROLINA
 Henry S. Gartner & Associates, Inc.
 2419 Tram Road
 New Bern, NC 28560
 Phone 919-633-1210
 Fax 919-633-1692
KEN WILLIAMS

(2) SO. MASS., RHODE ISLAND, LONG ISLAND
 Carswell, Gallagher, Williams Associates
 137 Brandt Island Rd.
 Mattapoisett, MA 02739
 Phone 508-758-2980/Fax 508-758-9705
WAYNE OLIVIERA



(7) GEORGIA
 Henry S. Gartner & Associates, Inc.
 6545 Lake Meadow Dr.
 Hixson, TN 37347
 Phone 615-843-3556/Fax 615-843-3555
ROBERT TAYLOR

(3) NEW JERSEY, DELAWARE, MARYLAND, E. PENNSYLVANIA
 Carswell, Gallagher, Williams Associates
 2201 Asbury Ave./P.O. Box 887
 Ocean City, NJ 08226
 Phone 609-398-7033/Fax 609-398-3117
JOHN BERGBAUER



(8) EASTERN & CENTRAL FLORIDA
 Henry S. Gartner & Associates, Inc.
 4305 Steed Terrace
 Winter Park, FL 32792
 Phone 407-677-6414
 Fax 407-677-7185
TRIPP HAMMACK

(3) NEW JERSEY, DELAWARE, MARYLAND, E. PENNSYLVANIA
 Carswell, Gallagher, Williams Associates
 3 Leavitt Lane
 Princeton, NJ 08540
 Phone 201-269-3234/Fax 201-269-6864
JAMES GALLAGHER



(9) SOUTHERN FLORIDA
 Henry S. Gartner & Associates, Inc.
 2470 N.E. 22 Street/P.O. Box 50227
 Lighthouse Point, FL 33064
 Phone 305-781-4303
 Fax 305-781-4412
JACK BARNES

(4) MARYLAND, VIRGINIA
 Carswell, Gallagher, Williams Associates
 1070 Ulmstead Circle
 Arnold, MD 21012
 Phone 301-757-9630
 Fax 301-757-4365
KEVIN WILLIAMS



(9) SOUTHERN FLORIDA
 Henry S. Gartner & Associates, Inc.
 2470 N.E. 22 Street/P.O. Box 50227
 Lighthouse Point, FL 33064
 Phone 305-781-4303
 Fax 305-781-4412
JAY BARNES

(5) N.Y. STATE, W. PENN., CENTRAL & E. CANADA
 Ed Sheldon & Associates, Inc.
 12 Cranswick Lane
 Rochester, NY 14618
 Phone 716-381-6845
 Fax 716-385-6928
CHARLES KUIMJIAN



(10) WESTERN & CENTRAL FLORIDA
 Henry S. Gartner & Associates, Inc.
 8300 Ulmerton Road/Suite A18F
 Largo, FL 34641
 Phone 813-535-2833
 Fax 813-531-8219
BRUCE WEBER

(11) LOUISIANA, AL., MISS., SO. EAST ARK.
 MAC-HUGH & Associates, Inc.
 5540 Pepsi Street
 Harahan, LA 70123
 Phone 504-734-9411
 Fax 504-734-5144
 KYLE McHUGH



(17) W. WASH., BRITISH COLUMBIA,
 ALBERTA, S.E. ALASKA
 Merifield Co., Inc.
 927 N.W. 50th St./P.O. Box 70626
 Seattle, WA 98107
 Phone 206-789-1800/Fax 206-783-7669
 JON EDWARDS

(11) LOUISIANA, AL., MISS., SO. EAST ARK.
 MAC-HUGH & Associates, Inc.
 5540 Pepsi Street
 Harahan, LA 70123
 Phone 504-734-9411/Fax 504-734-5144
 BUZZ HUMPHREY



(18) OREGON, W. IDAHO
 Merifield Co., Inc.
 10325 S.W. 57th Pl.
 Portland, OR 97219
 Phone 503-244-6451/Fax 503-245-7224
 JERRY LANAHAN

(11) LOUISIANA, AL., MISS., SO. EAST ARK.
 MAC-HUGH & Associates, Inc.
 5540 Pepsi Street
 Harahan, LA 70123
 Phone 504-734-9411
 Fax 504-734-5144
 DAVID HILDRETH



(19) E. IDAHO, MT., E. WASH., WYOMING
 Merifield Co., Inc.
 E. 3202 Diane Ct.
 Spokane, WA 99223
 Phone 509-448-0848
 Fax 509-448-2939
 TERRY HECKEL

(12) TENNESSEE
 MAC-HUGH & Associates, Inc.
 2022 Middle Settlement Rd.
 Maryville, TN 37801
 Phone 615-982-1150
 TOM GAVLICK



(20) CENTRAL & NO. ALASKA
 Merifield Co., Inc.
 750 W. Dimond/Suite 201
 Anchorage, AK 99515
 Phone 907-344-3825/Fax 907-349-7612
 BRUCE FRIEND

(13) TEXAS, OKLAHOMA, ARKANSAS
 MAC-HUGH & Associates, Inc.
 10830 Tri-Cities Beach Rd.
 Bay Town, TX 77520
 Phone 713-383-2235
 HUGH W. MULHOLLAND



(21) MISSOURI, KANSAS, IOWA,
 NO. & SO. DAKOTA, NEBRASKA
 Midwestern Sales Co., Inc.
 9849 Briar Drive
 Overland Park, KS 66207
 Phone 913-649-1270/Fax 913-649-2707
 DENNIS WILLIS

(14) SO. CA., SO. NV., ARIZONA,
 NEW MEXICO
 Merifield Co., Inc.
 P.O. Box 3160
 Tustin, CA 92680
 Phone 714-639-9462/Fax 714-639-9382
 DAN A. NABER



(21) MISSOURI, KANSAS, IOWA,
 NO. & SO. DAKOTA, NEBRASKA
 Midwestern Sales Co., Inc.
 9849 Briar Drive
 Overland Park, KS 66207
 Phone 913-649-1270/Fax 913-649-2707
 BILL LANNING

(15) NO. CA., NO. NV., UTAH, CO.
 Dugan & Associates, Inc.
 3368 McGraw Road
 Lafayette, CA 94549
 Phone 510-284-4855/Fax 510-284-4856
 WAYNE R. MOOERS



(22) NO. ILLINOIS, NO. INDIANA, W. MICHIGAN
 Inland Marketing Associates, Inc.
 601 Franklin Square/P.O. Box 680
 Michigan City, IN 46360
 Phone 219-879-2707/Fax 219-879-5224
 EARL HENDERSON

(16) HAWAII
 Dugan & Associates, Inc.
 632 Auwina Street
 Kailua, HI 96734
 Phone 808-262-2777
 Fax 808-262-2775
 MICHAEL D. MORELLI



(22) NO. ILLINOIS, NO. INDIANA, MN., WI.
 Inland Marketing Associates, Inc.
 730 N. Waukegan Rd./P.O. Box 325
 Deerfield, IL 60015
 Phone 708-945-0545
 Fax 708-945-0567
 WM. D. GREENE

(17) W. WASH., BRITISH COLUMBIA,
 ALBERTA, S.E. ALASKA
 Merifield Co., Inc.
 927 N.W. 50th St./P.O. Box 70626
 Seattle, WA 98107
 Phone 206-789-1800/Fax 206-783-7669
 TOM HARGER



(23) SO. ILLINOIS, SO. INDIANA, KENTUCKY,
 W. MICHIGAN
 Inland Marketing Associates, Inc.
 1071 Highland Ct./P.O. Box 414
 Plymouth, IN 46563
 Phone 219-936-6972/Fax 219-936-8248
 ED KUYKENDALL

(17) W. WASH., BRITISH COLUMBIA,
 ALBERTA, S.E. ALASKA
 Merifield Co., Inc.
 927 N.W. 50th St./P.O. Box 70626
 Seattle, WA 98107
 PHONE 206-789-1800/FAX 206-783-7669
 IVAN CROSS



(24) E. MICHIGAN, OHIO
 Inland Marketing Associates, Inc.
 500 S. Washington/Suite 11
 Royal Oak, MI 48067
 Phone 313-541-4404/Fax 313-541-4405
 R. WILLIAM BURT

PERKOPLATE/PERKO•KOTE LIMITED WARRANTY

PERKO, Inc. guarantees that all of its products finished with the PERKO-PLATE chromium plating process will maintain their original luster and brightness, or those finished with the PERKO•KOTE powder coating process will remain corrosion-free for as long as the original consumer-purchaser owns them. During the Warranty period, PERKO, Inc. agrees to repair or replace, (at PERKO's option) without cost to the original consumer-purchaser, any product upon which the PERKOPLATE chromium finish corrodes, becomes dull or otherwise does not maintain its original luster and brightness, or any product upon which the PERKO•KOTE finish corrodes. For this Warranty to be effective, the PERKO product must be returned prepaid and insured to PERKO, Inc. at its address shown below.

This Warranty is void if the PERKO-PLATE or PERKO•KOTE finish has been damaged by accident unreasonable use, neglect, improper service or other cause not arising out of defects in material or workmanship.

IN NO EVENT SHALL PERKO, INC. BE LIABLE FOR LOSS OF USE OF ITS CONSUMER PRODUCTS NOR FOR OTHER INCIDENTAL OR CONSEQUENTIAL COSTS, EXPENSES, OR DAMAGES INCURRED BY THE INDIVIDUAL. Some states do not allow the exclusion or limitation of incidental or consequential damage, so the above limitation may not apply to you. This Warranty gives you specific legal rights, and you may also have other rights which vary from state to state.

PERKO, Inc.
16490 N.W. 13th Avenue
Miami, Florida 33169-5707

PERKO®
WE MAKE IT RIGHT . . . RIGHT HERE

CERTIFICATION OF NAVIGATION LIGHTS FOR VESSELS UNDER 20 METERS (65.6 ft.) IN LENGTH

BACKGROUND (U.S.A.)

The National Marine Manufacturers Association (NMMA) is a trade association serving all elements of the recreational boating industry. It has developed certification programs to help manufacturers comply with established standards, safety regulations and help inform the public of such compliance when purchasing equipment.

In 1968 NMMA inaugurated a certification program for boat manufacturers including horsepower, load capacity, floatation, steering systems, fuel systems, compartment ventilation, *navigation lights* and backfire flame control. A manufacturer participating in this program must certify all models (except racing boats) as fitted with standard equipment on a model year basis. Inspectors from a nationally recognized independent testing laboratory then visit the manufacturer, and physically inspect each model for compliance *with all* boat certification standards.

During the past several years we have devoted a great deal of time and expense to field and laboratory testing in order to comply with NMMA standards and to enable us to certify accordingly.

PRESENT (U.S.A.)

Currently, federal regulations for navigation lights on vessels under 20 meters are split. The U.S.C.G. regulates and enforces the configuration and carriage of lights on the vessel, but industry standards regulate the design, manufacture, and certification of the lights. At this moment, the *only* means of certification widely recognized in the United States is through the NMMA program discussed above.

It is important to note that navigation lights can be tested and certified to meet the '72 COLREGS in a foreign country, however, each country has its own testing and certification procedure, which differs from the U.S. procedure. This means that a navigation light certified to meet the '72 COLREGS may be referring to approvals granted by another government, and can not be recognized by the U.S.C.G. for U.S. vessels until such time as the light passes the U.S. standards. At this time, our government has no plans to accept the foreign approvals as meeting the U.S. standards.

Our navigation lights presently are certified under the NMMA Certification Procedure. The marking "A-16" on the light fixture indicates this certification.

FUTURE (U.S.A.)

PERKO shall continue to progress in meeting the latest standards. Due to the somewhat volatile nature of the rulemaking on this subject, it is difficult to predict when, and in what exact form, new regulations will appear. Once this happens, we will have navigation lights certified to the new standard well in advance of the "effective dates" (the dates that the regulation specifies that *only* navigation lights certified to the new standard may be installed on a vessel). The U.S. Coast Guard has also indicated that a vessel under 20 meters which was fitted with navigation lights prior to an effective date, need not refit with lights certified to the new standard.

There are published rules covering the technical details of navigation lights in accordance with both the International Rules ('72 COLREGS) and the Inland Navigation Rules Act of 1980 (Public Law 96-591). These navigation rules are bound into a single volume and may be obtained from either the U.S. Coast Guard or the Superintendent of Documents by specifying "ComdtinstM16672.2."

To summarize, PERKO continues to manufacture navigation lights that meet all current and future U.S. regulations. The proper installation of a current model of PERKO navigation lights will assure the meeting of the U.S. regulation in effect at the time.

INTERNATIONAL REGULATIONS AND APPROVALS

Certain models and configurations of PERKO navigation lights have been approved for use in over 50 countries by their respective governing authorities. Where required, appropriate approval markings are on these navigation lights. However, due to frequent changes and additions to the approval list, contact PERKO for the latest information concerning model selection for a particular purpose and/or use in a particular country.

NOTE: All vertical height measurements on the following pages are from the mounting surface to the center of the bulb filament (per the chart on page 21).

BI-COLOR LIGHTS

FOR USE ON POWER DRIVEN VESSELS UNDER 12 METERS (39.4 ft.) IN LENGTH.

**Chrome Plated Bronze or Chrome Plated Zinc Tops
with Black Plastic Bases**

Patent No. 3,828,714

**1 Mile Visibility
Red and Green Lenses, Complete with 12 Volt Bulb.**

Fig. 1310 — Chrome Plated Zinc

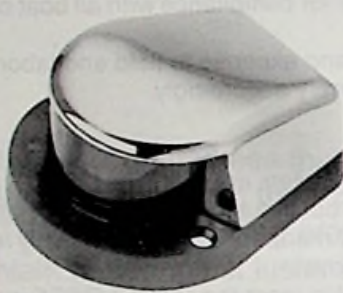

Fig. 1310

ORDERING INFORMATION

Dimensions	Vertical	Display Pkg.-5 pcs.	OEM Bulk Pkg.	Screw	Weight
Base	Height	1 Pc. per card	50 pcs.	Size	Ounces
Inches	Inches				
4 x 3 1/8	1	1310 DP CHR	1310 000 CHR	8	5 1/2

Fig. 1161 — Chrome Plated Bronze

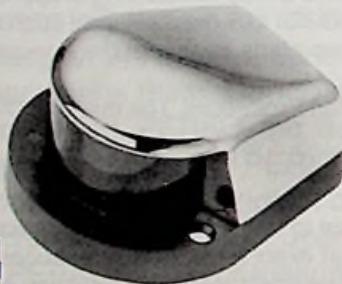

Fig. 1161

ORDERING INFORMATION

Dimensions	Vertical	Display Pkg.-5 pcs.	OEM Bulk Pkg.	Screw	Weight
Base	Height	1 Pc. per card	50 pcs.	Size	Ounces
Inches	Inches				
4 x 3 1/8	1	1161 DP CHR	1161 000 CHR	8	5 1/2

Fig. 1410 — Chrome Plated Zinc with Black Plastic Insert



Fig. 1410

ORDERING INFORMATION

Dimensions	Vertical	Display Pkg.-5 pcs.	OEM Bulk Pkg.	Screw	Weight
Base	Height	1 Pc. per card	50 pcs.	Size	Ounces
Inches	Inches				
4 x 3 1/8	1	1410 DP CHR	1410 000 CHR	8	5 1/2

NOTE: To Use The Lights on this Page in a 24 Volt System, Order Replacement Bulbs (2 per card) Cat. No. 72 DP1 CLR.

SPARE PARTS ORDERING INFORMATION

Spare Bulbs (2 per card), Cat. No. 71 DP CLR.
Spare Base with Socket Assembly, Cat. No. 136.

Spare Lens Set (1-red & 1-green), Cat. No. 283 DPA LNS.

BI-COLOR LIGHTS

FOR USE ON SAIL OR POWER DRIVEN VESSELS UNDER 12 METERS (39.4 ft.) IN LENGTH.

1 Mile Visibility

Red and Green Lenses, Complete with 12 Volt Bulb.

Fig. 904 — Chrome Plated Brass Top with Black Plastic Base



Fig. 904



ORDERING INFORMATION							
Length	Width	Vertical Height	Display Pkg.-5 pcs.	OEM Bulk Pkg.	Screw Size	Weight	
Inches	Inches	Inches	1 Pc. per card	10 pcs.		Ounces	
4 1/4	2 1/8	7/8	904 DP CHR	904 000 CHR	4	3 1/2	

Spare Bulbs (2 per card), Cat. No. 71 DP CLR. Spare Lens Set (1-red & 1-green), Cat. No. 296 DP LNS.
Spare Base with Socket Assembly, Cat. No. 107.

Fig. 972 — Chrome Plated Brass Top with Black Plastic Base



Fig. 972



ORDERING INFORMATION						
O.D. Base	Vertical Height	Display Pkg.-5 pcs.	OEM Bulk Pkg.	Screw Size	Weight	
Inches	Inches	1 Pc. per card	25 pcs.		Ounces	
2 3/8	7/8	972 DP CHR	972 000 CHR	4	3	

Spare Bulbs (2 per card), Cat. No. 71 DP CLR. Spare Lens Set (1-red & 1-green), Cat. No. 296 DP LNS.
Spare Base with Socket Assembly, Cat. No. 135.

**Fig. 120 — Chrome Plated Brass Tops with Black Plastic Bases,
Black or White Plastic Tops with Black Plastic Bases**



Fig. 120 MB

ORDERING INFORMATION							
Finish	Height		Width	Display Pkg.-5 pcs.	Std. Pkg.-1 pc.	Screw Size	Weight
	Overall	Projection					
	Inches	Inches	Inches	1 Pc. per card	OEM Pkg.-10 pcs.		Ounces
Chrome	3 5/8	2 1/2	4 1/8	120 MB DP1	120 MB 12V	10	5
Black	3 5/8	2 1/2	4 1/8	120 BB DP1	120 BB 12V	10	5
White	3 5/8	2 1/2	4 1/8	120 WB DP1	120 WB 12V	10	5

NOTE: See Pages 22 through 24 For Spare Parts Ordering Information.



Fig. 1218 — Chrome Plated Zinc with Flag Staff Socket
*For Use On Power Driven Vessels Only.



Fig. 1218



ORDERING INFORMATION						
Dimensions	Vertical	I.D.	Display Pkg.-5 pcs.	Screw Size	Weight	
Base	Height	Socket	1 Pc. per card		Ounces	
Inches	Inches	Inches				
6 1/4 x 3 7/8	1 5/8	3/4	1218 DP CHR	8	5 1/2	

Spare Bulbs (2 per card), Cat. No. 71 DP CLR. Spare Lens Set (1-red & 1-green), Cat. No. 259 DPA LNS.
Spare Socket Assembly, Cat. No. 1218 DP 99A.

NOTE: To Use The Lights on this Page (Except Fig. 120) in a 24 Volt System, Order Replacement Bulbs (2 per card) Cat. No. 72 DP1 CLR.

BI-COLOR LIGHTS

FOR USE ON SAIL* OR POWER DRIVEN VESSELS UNDER 12 METERS (39.4 ft.) IN LENGTH.

1 Mile Visibility

Red and Green Lenses, Complete with 12 Volt Bulb.



Fig. 1605



Fig. 1605 — Chrome Plated Zinc or Black Plastic Tops with Black Plastic Bases

ORDERING INFORMATION

Finish	Vertical Height	Height Overall	Dimensions Base	Display Pkg.	OEM Bulk Pkg.	Screw Size	Weight Ounces
	Inches	Inches	Inches	-5 pcs. 1 Pc. per card	50 pcs.		
Chrome	5/8	1 1/2	2 1/2 x 2	1605 DP CHR	1605 000 CHR	8	3
Black	5/8	1 1/2	2 1/2 x 2	1605 DP BLK	1605 000 BLK	8	3

Spare Bulbs (2 per card), Cat. No. 71 DP CLR.
Spare Base with Socket Assembly, Cat. No. 157 000 BLK.

Spare Lens (red & green), Cat. No. 289 DPA LNS.



Fig. 1606



Fig. 1606 — Chrome Plated Zinc or White Plastic Tops with White Plastic Bases

ORDERING INFORMATION

Finish	Vertical Height	Height Overall	Dimensions Base	Display Pkg.	OEM Bulk Pkg.	Screw Size	Weight Ounces
	Inches	Inches	Inches	-5 pcs. 1 Pc. per card	50 pcs.		
Chrome	5/8	1 1/2	2 1/2 x 2	1606 DP CHR	1606 000 CHR	8	3
White	5/8	1 1/2	2 1/2 x 2	1606 DP WHT	1606 000 WHT	8	3

Spare Bulbs (2 per card), Cat. No. 71 DP CLR.
Spare Base with Socket Assembly, Cat. No. 157 000 WHT.

Spare Lens (red & green), Cat. No. 289 DPA LNS.

Fig. 1603



Fig. 1603 — Black or White Plastic

ORDERING INFORMATION

Finish	Vertical Height	Height Overall	Dimensions Base	Display Pkg.	OEM Bulk Pkg.	Screw Size	Weight Ounces
	Inches	Inches	Inches	-5 pcs. 1 Pc. per card	50 pcs.		
Black	1 1/8	1 7/8	1 1/8 x 3	1603 DP BLK	1603 000 BLK	8	2 1/4
White	1 1/8	1 7/8	1 1/8 x 3	1603 DP WHT	1603 000 WHT	8	2 1/4

Spare Bulbs (2 per card), Cat. No. 71 DP CLR.
Spare Base with Socket Assembly, Cat. No. 139 000 BLK or 139 000 WHT.

Spare Lens Set (1-red & 1-green), Cat. No. 283 DPA LNS.

TRI-COLOR FIG. 1201

*For Use on Vessels Under Sail Alone Under 12 Meters (39.4 ft.) In Length.

Black Plastic and Chrome Plated Zinc Top with Chrome Plated Zinc Base
Red and Green Bi-Color — 1 Mile Visibility
White (Stern) — 2 Mile Visibility



Fig. 1201



ORDERING INFORMATION

Vertical Height	Dimensions Base	Display Pkg.	OEM Bulk Pkg.	Screw Size	Weight Ounces
		-5 pcs. 1 Pc. per card	50 pcs.		
3 1/4	1 X 2 5/8	1201 DP BLK	1201 000 BLK	8 R.H.	7

Spare Bulbs (2 per card), Cat. No. 71 DP CLR.
Spare White Lenses (2 per card), Cat. No. 278 DP WHT.

Spare Bi-Color Lens Set (1-red & 1-green), Cat. No. 268 DP LNS.
Spare Top Cap with Screw, Cat. No. 1158 DP BLK.

NOTE: To Use The Lights on this Page in a 24 Volt System, Order Replacement Bulbs (2 per card) Cat. No. 72 DP1 CLR.

REMOVABLE BI-COLOR LIGHTS

FOR USE ON SAIL OR POWER DRIVEN VESSELS UNDER 12 METERS (39.4 ft.) IN LENGTH.

**1 Mile Visibility — Red and Green Lenses, Complete with 12 Volt Bulb.
3/4 Inch Diameter Anodized Aluminum Tube — Waterproof Cover For Bases**

**Fig. 1211 — Black Plastic and Chrome Plated Zinc Top with Utility Light
Chrome Plated Brass and Black Plastic Base**

**Fig. 1212 — Black Plastic and Chrome Plated Zinc Top with Utility Light
Chrome Plated Zinc Base**

Deck Illuminating Utility Light in the Rear Section of the Top,
Controlled by a Switch Located on the Top Cover.



Vertical Height Inches	Dimensions Base Inches	ORDERING INFORMATION				
		Display Pkg.-5 pcs. 1 Pc. per card	OEM Bulk Pkg. 50 pcs.	Screw Size	Weight Ounces	
10	2 1/4 O.D.	1211 DP CHR	1211 000 CHR	8	8	
10 1/4	3 3/4 x 1 3/4	1212 DP CHR	1212 000 CHR	8	8	

Spare Bulbs for Bi-Color Section (2 per card), Cat. No. 71 DP CLR. Spare Bulb for Utility Light, Cat. No. 64 000 CLR.
Spare Mounting Base for Fig. No. 1211, Cat. No. 1045 300 DP. Spare Lens Set (1-red & 1-green), Cat. No. 268 DP LNS.
Spare Mounting Base for Fig. No. 1212, Cat. No. 1060 3B0 DP.



**Fig. 1296 — Black Plastic and Chrome Plated Zinc Top with Utility Light
and Chrome Plated Brass and Black Plastic Base**

Water Resistant Slide Cover Base

Deck Illuminating Utility Light in the Rear Section of the Top,
Controlled by a Switch Located on the Top Cover.



Vertical Height Inches	Dimensions Base Inches	ORDERING INFORMATION				
		Display Pkg.-5 pcs. 1 Pc. per card	OEM Bulk Pkg. 50 pcs.	Screw Size	Weight Ounces	
10	3 1/2 x 1 1/2	1296 DP CHR	1296 000 CHR	8	8	

Spare Bulbs for Bi-Color Section (2 per card), Cat. No. 71 DP CLR. Spare Bulb for Utility Light, Cat. No. 64 000 CLR.
Spare Mounting Base for Fig. No. 1211, Cat. No. 1047 3B0 DP. Spare Lens Set (1-red & 1-green), Cat. No. 268 DP LNS.



**Fig. 1612 — Black Plastic Top with
Chrome Plated Brass and Black Plastic Base.**

Vertical Height Inches	O.D. Base Inches	ORDERING INFORMATION				
		Display Pkg.-5 pcs. 1 Pc. per card	OEM Bulk Pkg. 50 pcs.	Screw Size	Weight Ounces	
9 3/4	2 1/4	1612 DP BLK	1612 000 BLK	8	7	

Spare Bulbs (2 per card), Cat. No. 71 DP CLR. Spare Lens Set (1-red & 1-green), Cat. No. 283 DP LNS.
Spare Mounting Base, Cat. No. 1045 P00 DP.



Fig. 1612

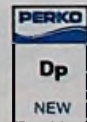

**Fig. 970 — Chrome Plated Brass Top with
Chrome Plated Brass and Black Plastic Base.**

Vertical Height Inches	O.D. Base Inches	ORDERING INFORMATION				
		Display Pkg.-5 pcs. 1 Pc. per card	OEM Bulk Pkg. 50 pcs.	Screw Size	Weight Ounces	
9 3/4	2 1/4	970 DP CHR	970 000 CHR	8	8	

Spare Bulbs (2 per card), Cat. No. 71 DP CLR. Spare Lens Set (1-red & 1-green), Cat. No. 296 DP LNS.
Spare Mounting Base, Cat. No. 1045 P00 DP.



Fig. 970

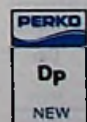

NOTE: To Use Figs. 970 or 1612 Above in a 24 Volt System, Order Replacement Bulbs (2 per card) Cat. No. 72 DP1 CLR.

SIDE LIGHTS

FOR USE ON SAIL* OR POWER DRIVEN VESSELS UNDER 12 METERS (39.4 ft.) IN LENGTH.

1 Mile Visibility — Red and Green Lenses, Complete with 12 Volt Bulbs.



Fig. 915

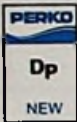

**Fig. 915 — Chrome Plated Brass Tops with Black Plastic Bases
Horizontal Surface Mount**

ORDERING INFORMATION

Length Inches	Width Inches	Vertical	Display Pkg.-5 prs. 1 Pr. per card	OEM Bulk Pkg. 10 prs.	Screw Size	Weight per Pair Ounces
		Height Inches				
4 1/4	2 3/8	7/8	915 DP CHR	915 000 CHR	4	7
Green Side Light Only, Cat. No. 915 G00 CHR.			Spare Lens Set (1-red & 1-green), Cat. No. 281 DPA LNS.			
Red Side Light Only, Cat. No. 915 R00 CHR.			Spare Base with Socket Assembly, Cat. No. 107.			
Spare Bulbs (2 per card), Cat. No. 71 DP CLR.						



Fig. 955



**Fig. 955 — Chrome Plated Brass Tops with Black Plastic Bases
Vertical Surface Mount**

ORDERING INFORMATION

Length Inches	Width Inches	Projection	Display Pkg.-5 prs. 1 Pr. per card	OEM Bulk Pkg. 10 prs.	Screw Size	Weight per Pair Ounces
		Overall Inches				
4 1/4	2 3/8	1 5/8	955 DP CHR	955 000 CHR	4	7
Green Side Light Only, Cat. No. 955 G00 CHR.			Spare Lens Set (1-red & 1-green), Cat. No. 260 DP LNS.			
Red Side Light Only, Cat. No. 955 R00 CHR.			Spare Base with Socket Assembly, Cat. No. 955 000 99A.			
Spare Bulbs (2 per card), Cat. No. 71 DP CLR.						



Fig. 963



**Fig. 963 — Chrome Plated Brass Tops with Black Plastic Bases
Horizontal Surface Mount**

ORDERING INFORMATION

O.D. Base Inches	Vertical Height Inches	Display Pkg.-5 cds. 1Pr. per card	OEM Bulk Pkg. 10 prs.	Screw Size	Weight per Pair Ounces
Green Side Light Only, Cat. No. 963 G00 CHR.			Spare Lens Set (1-red & 1-green), Cat. No. 281 DPA LNS.		
Red Side Light Only, Cat. No. 963 R00 CHR.			Spare Base with Socket Assembly, Cat. No. 135.		
Spare Bulbs (2 per card), Cat. No. 71 DP CLR.					

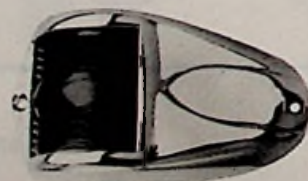
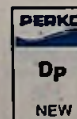

Fig. 1264



**Fig. 1264 — Chrome Plated Zinc with Black Vinyl Mounting Gasket
Vertical Surface Mount**

* For Use On Power Driven Vessels Only

ORDERING INFORMATION

Length Inches	Width Inches	Projection	Display Pkg.-5 prs. 1 Pr. per card	Screw Size	Weight per Pair Pounds
		Overall Inches			
5 1/2	3 1/8	1 3/4	1264 DP CHR	8	1 3/4
Green Side Light Only, Cat. No. 1264 G00 CHR.			Spare Lens Set (1-red & 1-green), Cat. No. 1264 DP LNS.		
Red Side Light Only, Cat. No. 1264 R00 CHR.			Spare Socket Assembly, Cat. No. 1264 DP 99A.		
Spare Bulbs (2 per card), Cat. No. 71 DP CLR.					

NOTE: To Use The Lights on this Page in a 24 Volt System, Order Replacement Bulbs (2 per card) Cat. No. 72 DP1 CLR.

SIDE LIGHTS

FOR USE ON SAIL OR POWER DRIVEN VESSELS AS SPECIFIED BELOW.
Red and Green Lenses, Complete with 12 Volt or 24 Volt Bulbs.

Figs. 120 and 170 — Chrome Plated Brass Tops with Black Plastic Bases, Black or White Plastic Tops with Black Plastic Bases

Height Overall Inches	Projection Overall Inches	Width Inches	Screw Size	Weight Ounces
3 5/8	2 1/2	4 1/8	10	5

Fig. 120 — For Use On Sail or Power Driven Vessels Under 12 Meters (39.4 ft.) In Length (12 Volts Only).

ORDERING INFORMATION

Description	Display Pkg.-5 pcs.	Std. Pkg.-1 pc.
	1 Pc. per card	OEM Pkg.-10 pcs.
Chrome		
Red Side Light	120 MP DP1	120 MP 12V
Green Side Light	120 MSD DP1	120 MSD 12V
Black Plastic		
Red Side Light	120 BP DP1	120 BP 12V
Green Side Light	120 BSD DP1	120 BSD 12V
White Plastic		
Red Side Light	120 WP DP1	120 WP 12V
Green Side Light	120 WSD DP1	120 WSD 12V



Figs. 120 MSD & 170 MSD



Figs. 120 BSD & 170 BSD



Fig. 170 — For Use On Sail or Power Driven Vessels Under 20 Meters (65.6 ft.) In Length (12 or 24 Volts).

ORDERING INFORMATION

ORDERING INFORMATION

Description	<u>12 Volt</u>		<u>24 Volt</u>	
	Display Pkg.-5 pcs. 1 Pc. per card	Std. Pkg.-1 pc. OEM Pkg.-10 pcs.	Display Pkg.-5 pcs. 1 Pc. per card	Std. Pkg.-1 pc. OEM Pkg.-10 pcs.
Chrome				
Red Side Light	170 MP DP1	170 MP 12V	170 MP DP2	170 MP 24V
Green Side Light	170 MSD DP1	170 MSD 12V	170 MSD DP2	170 MSD 24V
Black Plastic				
Red Side Light	170 BP DP1	170 BP 12V	170 BP DP2	170 BP 24V
Green Side Light	170 BSD DP1	170 BSD 12V	170 BSD DP2	170 BSD 24V
White Plastic				
Red Side Light	170 WP DP1	170 WP 12V	170 WP DP2	170 WP 24V
Green Side Light	170 WSD DP1	170 WSD 12V	170 WSD DP2	170 WSD 24V



Figs. 170 WSD & 170 WSD



NOTE: For The Above Lights See Pages 22 through 24 For Spare Parts Ordering Information.

Fig. 1601 — Black or White Plastic — Normal "Base-Down" Mount

For Use On Sail or Power Driven Vessels Under 12 Meters (39.4 ft.) In Length (12 Volt).

Finish	Vertical Height Dimensions			ORDERING INFORMATION			
	Height Inches	Overall Inches	Base Inches	Display Pkg.-5 prs. 1 Pr. per card	OEM Bulk Pkg. 25 prs.	Screw Size	Weight Ounces
Black	1 1/8	1 7/8	1 1/8 X 3	1601 DP BLK	1601 000 BLK	8	2 1/4
White	1 1/8	1 7/8	1 1/8 X 3	1601 DP WHT	1601 000 WHT	8	2 1/4

Fig. 1601

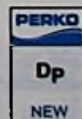

Fig. 1602 — Black or White Plastic — Inverted "Base-Up" Mount

For Use On Sail or Power Driven Vessels Under 12 Meters (39.4 ft.) In Length (12 Volt).

Finish	Vertical Height Dimensions			ORDERING INFORMATION			
	Height Inches	Overall Inches	Base Inches	Display Pkg.-5 prs. 1 Pr. per card	OEM Bulk Pkg. 25 prs.	Screw Size	Weight Ounces
Black	1 1/8	1 7/8	1 1/8 X 3	1602 DP BLK	1602 000 BLK	8	2 1/4
White	1 1/8	1 7/8	1 1/8 X 3	1602 DP WHT	1602 000 WHT	8	2 1/4

Fig. 1602



Spare Bulbs (2 per card), Cat. No. 71 DP CLR.

Spare Lens Set (1-red & 1-green), Cat. No. 283 DPA LNS.

Spare Base with Socket Assembly, Cat. No. 139 000 BLK or 139 000 WHT.

NOTE: To Use Figs. 1601 or 1602 Above in a 24 Volt System, Order Replacement Bulbs (2 per card) Cat. No. 72 DP1 CLR.

STERN LIGHTS

FOR USE ON SAIL OR POWER DRIVEN VESSELS UNDER 20 METERS (65.6 ft.) IN LENGTH.

2 Mile Visibility — Clear Lens, Complete with 12 Volt Bulb.



Fig. 965



Fig. 945

Fig. 945 — Chrome Plated Brass Top with Black Plastic Base Vertical Surface Mount

Fig. 965 — Chrome Plated Brass Top with Black Plastic Base Horizontal Surface Mount

O.D. Base Inches	Projection/Height Overall Inches	ORDERING INFORMATION			
		Display Pkg. -5 pcs. 1 Pc. per card	OEM Bulk Pkg. 25 pcs.	Screw Size	Weight Ounces
2 3/8	1 5/8	945 DP CHR	945 000 CHR	4	3
2 3/8	1 5/8	965 DP CHR	965 000 CHR	4	3



Spare Bulbs For Both (2 per card), Cat. No. 71 DP CLR.
Spare Base and Socket Assembly For Fig. No. 965, Cat. No. 135.
Spare Base and Socket Assembly For Fig. No. 945, Cat. No. 945 DP 99A.

Spare Lens For Fig. No. 945, Cat. No. 74 DP WHT.
Spare Lens For Fig. No. 965, Cat. No. 281 DPA WHT.



Fig. 940

Fig. 940 — Chrome Plated Brass Top with Chrome Plated Brass and Black Plastic Base Horizontal Surface Mount

Height Overall Inches	O.D. Base Inches	ORDERING INFORMATION			
		Display Pkg. -5 pcs. 1 Pc. per card	OEM Bulk Pkg. 50 pcs.	Screw Size	Weight Ounces
16	2 1/4	940 DP CHR	940 000 CHR	8	8

Spare Bulbs (2 per card), Cat. No. 71 DP CLR.
Spare Base Cat. No. 1045 P00 DP.

Spare Lens , Cat. No. 281 DPA WHT.



NOTE: To Use The Above Lights in a 24 Volt System, Order Replacement Bulbs (2 per card), Cat. No. 72 DP1 CLR.



Fig. 939

Fig. 939 — Chrome Plated Brass Top with Black Plastic Base Vertical Flush Mount

Dimensions Inches	Depth Inches	ORDERING INFORMATION			
		Display Pkg. -5 pcs. 1 Pc. per card	OEM Bulk Pkg. 20 pcs.	Screw Size	Weight Ounces
5 3/16 x 3 3/8	1 1/2	939 DP1 12V	939 001 12V	8	4
5 3/16 x 3 3/8	1 1/2	939 DP3 32V	-----	8	4

Spare 12 Volt Bulbs (2 per card), Cat. No. 70 DP0 CLR. Spare 12 Volt Socket Assembly, Cat. No. 939 DP1 99A.
Spare 32 Volt Bulbs (2 per card), Cat. No. 70 DP2 CLR. Spare 32 Volt Socket Assembly, Cat. No. 939 003 99A.
Spare Lens with Gasket, Cat. No. 284 DP CLR. Spare Mounting Flange, Cat. No. 939 000 99C.

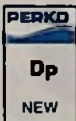

Fig. 946 — Chrome Plated Brass with Black Plastic Base Vertical Flush Mount



Fig. 946

O.D. Inches	Depth Inches	ORDERING INFORMATION			
		Display Pkg. -5 pcs. 1 Pc. per card	OEM Bulk Pkg. 25 pcs.	Screw Size	Weight Ounces
3	1	946 DP1 12V	946 001 12V	8	4
3	1	946 DP3 32V	-----	8	4

Spare 12 Volt Bulbs (2 per card), Cat. No. 70 DP0 CLR. Spare 12 Volt Socket Assembly, Cat. No. 946 DP1 99B.
Spare 32 Volt Bulbs (2 per card), Cat. No. 70 DP2 CLR. Spare 32 Volt Socket Assembly, Cat. No. 946 003 99B.
Spare Lens with Gasket, Cat. No. 946 DP 99A. Spare Mounting Flange, Cat. No. 946 000 99C.

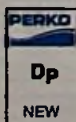

STERN LIGHTS

FOR USE ON SAIL OR POWER DRIVEN VESSELS UNDER 20 METERS (65.6 ft.) IN LENGTH.

2 Mile Visibility — Clear Lens, Complete with 12 Volt or 24 Volt Bulb.

**Fig. 170 — Chrome Plated Brass Tops with Black Plastic Bases,
Black or White Plastic Tops with Black Plastic Bases**

**Vertical Surface Mount
12 Volt or 24 Volt Bulbs**



Fig. 170 MSN



Fig. 170 BSN

ORDERING INFORMATION — For 12 Volt Lights

Finish	Height		Width	Display Pkg.-5 pcs. 1 Pc. per card	Std. Pkg.-1 pc. OEM Pkg.-10 pcs.	Screw Size	Weight Ounces
	Overall Inches	Projection Inches					
Chrome	3 5/8	2 1/2	4 1/8	170 MSN DP1	170 MSN 12V	10	5
Black	3 5/8	2 1/2	4 1/8	170 BSN DP1	170 BSN 12V	10	5
White	3 5/8	2 1/2	4 1/8	170 WSN DP1	170 WSN 12V	10	5

ORDERING INFORMATION — For 24 Volt Lights

Finish	Height		Width	Display Pkg.-5 pcs. 1 Pc. per card	Std. Pkg.-1 pc. OEM Pkg.-10 pcs.	Screw Size	Weight Ounces
	Overall Inches	Projection Inches					
Chrome	3 5/8	2 1/2	4 1/8	170 MSN DP2	170 MSN 24V	10	5
Black	3 5/8	2 1/2	4 1/8	170 BSN DP2	170 BSN 24V	10	5
White	3 5/8	2 1/2	4 1/8	170 WSN DP2	170 WSN 24V	10	5



Fig. 170 WSN



NOTE: See Pages 22 through 24 For Spare Parts Ordering Information.

**Fig. 120 — Chrome Plated Brass Tops with Black Plastic Bases,
Black or White Plastic Tops with Black Plastic Bases**

**Vertical Surface Mount
12 Volt Bulbs**



Fig. 120 MSN



Fig. 120 BSN

ORDERING INFORMATION

Finish	Height		Width	Display Pkg.-5 pcs. 1 Pc. per card	Std. Pkg.-1 pc. OEM Pkg.-10 pcs.	Screw Size	Weight Ounces
	Overall Inches	Projection Inches					
Chrome	3 5/8	2 1/2	4 1/8	120 MSN DP1	120 MSN 12V	10	5
Black	3 5/8	2 1/2	4 1/8	120 BSN DP1	120 BSN 12V	10	5
White	3 5/8	2 1/2	4 1/8	120 WSN DP1	120 WSN 12V	10	5



Fig. 120 WSN



NOTE: See Pages 22 through 24 For Spare Parts Ordering Information.

Fig. 1332 — Chrome Plated Zinc with Black Plastic Base

**Vertical Surface Mount
12 Volt Bulb**



Fig. 1332

ORDERING INFORMATION

Length Inches	Width Inches	Display Pkg.-5 pcs. 1 Pc. per card	OEM Bulk Pkg. 50 pcs.	Screw Size	Weight Ounces
3 3/4	1 1/2	1332 DP CHR	1332 000 CHR	5	4

Spare Bulbs (2 per card), Cat. No. 71 DP CLR. Spare Lenses (2 per card), Cat. No. 278 DP WHT.

NOTE: To Use This Light in a 24 Volt System, Order Replacement Bulbs (2 per card) Cat. No. 72 DP1 CLR.

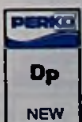

MASTHEAD LIGHTS

FOR USE ON SAIL OR POWER DRIVEN VESSELS AS SPECIFIED BELOW.

Clear Lens, Complete with 12 Volt or 24 Volt Bulb.



Fig. 170 MM



Fig. 170 BM



Fig. 170 WM



Fig. 170 — Chrome Plated Brass Tops with Black Plastic Bases, Black or White Plastic Tops with Black Plastic Bases
For Use On Vessels Under 20 Meters (65.6 ft.) In Length.

Vertical Surface Mount
3 Mile Visibility — 12 Volt or 24 Volt Bulbs

ORDERING INFORMATION — For 12 Volt Lights

Finish	Height		Projection	Width	Display Pkg.-5 pcs. 1 Pc. per card	Std. Pkg.-1 pc. OEM Pkg.-10 pcs.	Screw Size	Weight Ounces
	Overall Inches	Overall Inches						
Chrome	3 5/8	2 1/2	4 1/8	170 MM DP1	170 MM 12V	10	5	
Black	3 5/8	2 1/2	4 1/8	170 BM DP1	170 BM 12V	10	5	
White	3 5/8	2 1/2	4 1/8	170 WM DP1	170 WM 12V	10	5	

ORDERING INFORMATION — For 24 Volt Lights

Finish	Height		Projection	Width	Display Pkg.-5 pcs. 1 Pc. per card	Std. Pkg.-1 pc. OEM Pkg.-10 pcs.	Screw Size	Weight Ounces
	Overall Inches	Overall Inches						
Chrome	3 5/8	2 1/2	4 1/8	170 MM DP2	170 MM 24V	10	5	
Black	3 5/8	2 1/2	4 1/8	170 BM DP2	170 BM 24V	10	5	
White	3 5/8	2 1/2	4 1/8	170 WM DP2	170 WM 24V	10	5	

NOTE: See Pages 22 through 24 For Spare Parts Ordering Information.



Fig. 120 BM



Fig. 120 MM



Fig. 120 WM



Fig. 120 — Chrome Plated Brass Tops with Black Plastic Bases, Black or White Plastic Tops with Black Plastic Bases
For Use On Vessels Under 12 Meters (39.4 ft.) In Length.

Vertical Surface Mount
2 Mile Visibility — 12 Volt Bulbs

ORDERING INFORMATION

Finish	Height		Projection	Width	Display Pkg.-5 pcs. 1 Pc. per card	Std. Pkg.-1 pc. OEM Pkg.-10 pcs.	Screw Size	Weight Ounces
	Overall Inches	Overall Inches						
Chrome	3 5/8	2 1/2	4 1/8	120 MM DP1	120 MM 12V	10	5	
Black	3 5/8	2 1/2	4 1/8	120 BM DP1	120 BM 12V	10	5	
White	3 5/8	2 1/2	4 1/8	120 WM DP1	120 WM 12V	10	5	

NOTE: See Pages 22 through 24 For Spare Parts Ordering Information.

Fig. 120 — Combination Masthead and Deck Spreader Light, Black Plastic
For Use On Vessels Under 12 Meters (39.4 ft.) In Length.

Vertical Mount
2 Mile Visibility — 12 Volt Bulbs

ORDERING INFORMATION

Height Overall Inches	Projection Overall Inches	Width Inches	Display Pkg.-5 pcs. 1 Pc. per card	Std. Pkg.-1 pc. OEM Pkg.-10 pcs.	Screw Size	Weight Ounces



Fig. 120 BMD



NOTE: See Page 22 For Spare Parts Ordering Information.

MASTHEAD LIGHTS

FOR USE ON SAIL OR POWER DRIVEN VESSELS AS SPECIFIED BELOW.

Clear Lens, Complete with 12 Volt Bulb.

Fig. 964 — Chrome Plated Brass Top with Black Plastic Base
For Use On Vessels Under 12 Meters (39.4 ft.) In Length.

Horizontal Surface Mount
2 Mile Visibility



Fig. 964



ORDERING INFORMATION

O.D. Base Inches	Vertical Height Inches	Display Pkg. -5 pcs. 1 Pc. per card	OEM Bulk Pkg. 25 pcs.	Screw Size	Weight Ounces
2 3/8	7/8	964 DP CHR	964 000 CHR	4	3

Spare Bulbs (2 per card), Cat. No. 71 DP CLR. Spare Base with Socket Assembly, Cat. No. 135.
Spare Lens, Cat. No. 281 DPA WHT.

Fig. 1331 — Chrome Plated Zinc with Black Plastic Base
For Use On Vessels Under 20 Meters (65.6 ft.) In Length.

Vertical Surface Mount
3 Mile Visibility



Fig. 1331



ORDERING INFORMATION

Length Inches	Width Inches	Display Pkg. -5 pcs. 1 Pc. per card	OEM Bulk Pkg. 50 pcs.	Screw Size	Weight Ounces
3 3/4	1 1/2	1331 DP CHR	1331 000 CHR	5	4

Spare Bulbs (2 per card), Cat. No. 71 DP CLR. Spare Lenses (2 per card), Cat. No. 278 DP WHT.

Fig. 1178 — Black Plastic and Chrome Plated Zinc Top with Chrome Plated Zinc Base
For Use On Vessels Under 20 Meters (65.6 ft.) In Length.

Horizontal Surface Mount
3 Mile Visibility



Fig. 1178



ORDERING INFORMATION

Vertical Dimensions		Display Pkg. -5 pcs. 1 Pc. per card	OEM Bulk Pkg. 50 pcs.	Screw Size	Weight Ounces
Height Inches	Base Inches	1178 DP CHR	1178 000 CHR	8 R.H.	7
3 1/4	1 x 2 5/8				

Spare Bulbs (2 per card), Cat. No. 71 DP CLR. Spare Lenses (2 per card), Cat. No. 278 DP WHT.
Spare Top Cap and Screw, Cat. No. 1158 DP BLK.

NOTE: To Use The Lights On This Page in a 24 Volt System, Order Replacement Bulbs (2 per card.) Cat. No. 72 DP1 CLR.

COMBINATION MASTHEAD AND WHITE ALL-ROUND LIGHTS FOR USE ON SAIL OR POWER DRIVEN VESSELS UNDER 20 METERS (65.6 ft.) IN LENGTH.

3 Mile Visibility
Clear Lenses, Complete with Two 12 Volt Bulbs.
Black Plastic and Chrome Plated Zinc Tops with Chrome Plated Zinc Bases.
3/4 Inch Diameter Anodized Aluminum Tubes

**Fig. 1181 — Fold-Down, Adjustable Angle, Horizontal Mount
Plastic Adapters for Flat or "V" Type Mount**



Fig. 1181

ORDERING INFORMATION

Vertical Height Inches	Dimensions Bracket Inches	ORDERING INFORMATION		Screw Size	Weight Pounds
		Display Pkg.-5 pcs. 1 Pc. per card	OEM Bulk Pkg. 50 pcs.		
12 5/8	2 x 1 1/2	1181 DP CHR	1181 000 CHR	8	3/4

Spare Bracket with Knob and End Plug, Cat. No. 1052 DP CHR.
Spare Knob, Cat. No. 1144 A00 BLK.

**Fig. 1184 — Fold-Down, Adjustable Angle, Vertical Mount
Plastic Adapters for Flat or "V" Type Mount**



Fig. 1184

ORDERING INFORMATION

Vertical Height Inches	Dimensions Bracket Inches	ORDERING INFORMATION		Screw Size	Weight Pounds
		Display Pkg.-5 pcs. 1 Pc. per card	OEM Bulk Pkg. 50 pcs.		
12 5/8	2 1/4 x 5/8	1184 DP CHR	1184 000 CHR	8	3/4

Spare Bracket with Knob and End Plug, Cat. No. 1054 DP CHR.
Spare Knob, Cat. No. 1144 A00 BLK.



Figs. 1183 and 1196 — Fixed Mount



Fig. 1196



Fig. 1183



Fig. 1197

ORDERING INFORMATION

Vertical Height Inches	Dimensions Base Inches	ORDERING INFORMATION		Screw Size	Weight Ounces
		Display Pkg.-5 pcs. 1 Pc. per card	OEM Bulk Pkg. 50 pcs.		
3 1/4	1 x 2 5/8	1183 DP CHR	1183 000 CHR	8 R.H.	7
5 1/4	1 x 2 5/8	1196 DP1 CHR	1196 001 CHR	8 R.H.	8
11 1/4	1 x 2 5/8	1196 DP2 CHR	1196 002 CHR	8 R.H.	8

Fig. 1197 — Fixed Mount

ORDERING INFORMATION

Vertical Height Inches	Length Tubing Inches	ORDERING INFORMATION		Weight Ounces
		Display Pkg.-5 pcs. 1 Pc. per card	OEM Bulk Pkg. 50 pcs.	
4	1	1197 DP CHR	1197 000 CHR	7

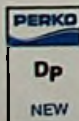

NOTE: To Use The Lights on this Page in a 24 Volt System, Order Replacement Bulbs (2 per card) Cat. No. 72 DP1 CLR.

SPARE PARTS ORDERING INFORMATION

Spare Bulbs (2 per card), Cat. No. 71 DP CLR. Spare Lenses (2 per card), Cat. No. 278 DP WHT.
Spare Top Cap with Screw, Cat. No. 1158 DP BLK.

COMBINATION MASTHEAD AND WHITE ALL-ROUND LIGHTS FOR USE ON SAIL OR POWER DRIVEN VESSELS UNDER 20 METERS (65.6 ft.) IN LENGTH.

Stow-A-Way Plug-In Type

3 Mile Visibility

Clear Lenses, Complete with Two 12 Volt Bulbs.

Black Plastic and Chrome Plated Zinc Top, 3/4 Inch Diameter Anodized Aluminum Tubes, Waterproof Cover For Bases

Fig. 1123 — Horizontal Mount

Chrome Plated Zinc Mounting Bracket
Plastic Adapters for Flat or "V" Type 45 Degree Windshields.

Vertical Height Inches	ORDERING INFORMATION Display Pkg.-5 pcs. 1 Pc. per card	OEM Bulk Pkg. 50 pcs.	Screw Size	Weight Pounds
11 1/2	1123 DP1 CHR	1123 001 CHR	8	1
20 3/4	1123 DP2 CHR	1123 002 CHR	8	1 1/8

Spare Bulbs (2 per card), Cat. No. 71 DP CLR. Spare Cap for Base, Cat. No. 125 DP BLK.
Spare Lenses (2 per card), Cat. No. 278 DP WHT. Spare Base with Socket Assembly, Cat. No. 1123 DP 99A.
Spare Top Cap with Screw, Cat. No. 1158 DP BLK.



Fig. 1123



Fig. 1124 — Vertical Mount

Chrome Plated Zinc Mounting Bracket
Plastic Adapters for Flat or "V" Type 45 Degree Windshields.

Vertical Height Inches	ORDERING INFORMATION Display Pkg.-5 pcs. 1 Pc. per card	OEM Bulk Pkg. 50 pcs.	Screw Size	Weight Pounds
11 1/2	1124 DP1 CHR	1124 001 CHR	8	1
20 3/4	1124 DP2 CHR	1124 002 CHR	8	1 1/8

Spare Bulbs (2 per card), Cat. No. 71 DP CLR. Spare Cap for Base, Cat. No. 125 DP BLK.
Spare Lenses (2 per card), Cat. No. 278 DP WHT. Spare Base with Socket Assembly, Cat. No. 1124 DP 99A.
Spare Top Cap with Screw, Cat. No. 1158 DP BLK.



Fig. 1124



Fig. 1125 — Deck Mount

Chrome Plated Brass Base

Vertical Height Inches	Dimensions Base Inches	ORDERING INFORMATION Display Pkg.-5 pcs. 1 Pc. per card	OEM Bulk Pkg. 50 pcs.	Screw Size	Weight Pounds
33 5/8	3 3/8 x 2 1/4	1125 DP4 CHR	1125 004 CHR	8	1 1/2

Spare Bulbs (2 per card), Cat. No. 71 DP CLR. Spare Cap for Base, Cat. No. 125 DP BLK.
Spare Lenses (2 per card), Cat. No. 278 DP WHT. Spare Base with Socket Assembly, Cat. No. 1125 DP 99A.
Spare Top Cap with Screw, Cat. No. 1158 DP BLK.



Fig. 1125

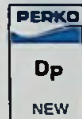

NOTE: To Use The Lights Above in a 24 Volt System, Order Replacement Bulbs (2 per card) Cat. No. 72 DP1 CLR.

GLARE SHIELD FIG. 1192

Black Plastic

For 3/4 Inch O.D. Tubing, Can Be Installed Without Removing Light.

Dimensions Inches	ORDERING INFORMATION Display Pkg.-5 pcs. 1 Pc. per bag	OEM Bulk Pkg. 25 pcs.	Weight Ounces
6 x 4 5/16	1192 DP BLK	1192 000 BLK	3

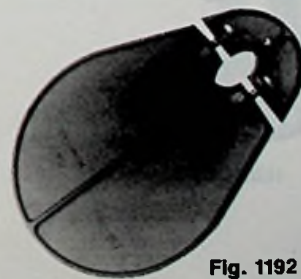

Fig. 1192



WHITE ALL-ROUND LIGHTS

FOR USE ON SAIL OR POWER DRIVEN VESSELS UNDER 20 METERS (65.6 ft.) IN LENGTH.

Stow-A-Way Plug-In Type

2 Mile Visibility

Complete With 12 Volt Bulb

3/4 Inch Diameter Anodized Aluminum Tubes,
Water Resistant Slide Cover For Bases



Fig. 1640

Fig. 1640 — White Translucent Globe, Black Plastic Top,
with Black Plastic and Chrome Plated Brass Base

ORDERING INFORMATION

Vertical Height Inches	Display Pkg.-5 pcs. 1 Pc. per card	OEM Bulk Pkg. 50 pcs.	Weight Pounds
20 5/8	1640 DP2 CHR	1640 002 CHR	1
27 1/8	1640 DP3 CHR	1640 003 CHR	1 1/8
33 1/4	1640 DP4 CHR	1640 004 CHR	1 1/4
40 1/2	1640 DP5 CHR	1640 005 CHR	1 3/8
46 1/2	1640 DP6 CHR	1640 006 CHR	1 1/2
51 1/2	1640 DP7 CHR	1640 007 CHR	1 5/8

Base Length 3 1/2", Width 1 1/2", Screw Size #8.

Spare Bulbs (2 per card), Cat. No. 337 012 DP. Spare Globe, Cat. No. 201 DP WHT.
Spare Base with Socket Assembly, Cat. No. 1046 P00 DP.



Fig. 1660

Fig. 1660 — White Translucent Globe, Black Plastic Top,
with Black Plastic and Chrome Plated Brass Base

ORDERING INFORMATION

Vertical Height Inches	Display Pkg.-5 pcs. 1 Pc. per card	OEM Bulk Pkg. 50 pcs.	Weight Pounds
40 5/8	1660 DP5 CHR	1660 005 CHR	1 3/8
46 5/8	1660 DP6 CHR	1660 006 CHR	1 1/2
51 5/8	1660 DP7 CHR	1660 007 CHR	1 5/8

Base Length 3 1/2", Width 1 1/2", Screw Size #8.

Spare Bulbs (2 per card), Cat. No. 337 012 DP. Spare Globe, Cat. No. 201 DP WHT.
Spare Base with Socket Assembly, Cat. No. 1047 P00 DP.



WHITE ALL-ROUND LIGHTS

FOR USE ON SAIL OR POWER DRIVEN VESSELS UNDER 20 METERS (65.6 ft.) IN LENGTH.

Stow-A-Way Plug-In Type

2 Mile Visibility

Complete With 12 Volt Bulb

3/4 Inch Diameter Anodized Aluminum Tubes,
Waterproof Cover For Bases

Fig. 1430 — White Translucent Globe, Black Plastic Top, Chrome Plated Zinc Base with Black Plastic Insert

ORDERING INFORMATION

Vertical Height Inches	Display Pkg. -5 pcs. 1 Pc. per card	OEM Bulk Pkg. 50 pcs.	Weight Pounds
21	1430 DP2 CHR	1430 002 CHR	1
27 1/4	1430 DP3 CHR	1430 003 CHR	1 1/8
33 1/2	1430 DP4 CHR	1430 004 CHR	1 1/4
40 3/4	1430 DP5 CHR	1430 005 CHR	1 3/8
46 3/4	1430 DP6 CHR	1430 006 CHR	1 1/2
51 3/4	1430 DP7 CHR	1430 007 CHR	1 5/8

Base Length 3 3/4", Width 1 3/4", Screw Size #8.

Spare Bulbs (2 per card), Cat. No. 337 012 DP.

Spare Globe, Cat. No. 201 DP WHT.

Spare Base with Socket Assembly, Cat. No. 1060 PB0 DP.



Fig. 1430



Fig. 1631 — White Translucent Globe, Black Plastic Top, Chrome Plated Brass and Black Plastic Base

ORDERING INFORMATION

Vertical Height Inches	Display Pkg. -5 pcs. 1 Pc. per card	OEM Bulk Pkg. 50 pcs.	Weight Pounds
40 1/4	1631 DP5 CHR	1631 005 CHR	1 3/8
46 3/4	1631 DP6 CHR	1631 006 CHR	1 1/2
51 3/4	1631 DP7 CHR	1631 007 CHR	1 5/8

O.D. Base 2 1/4", Screw Size #8.

Spare Bulbs (2 per card), Cat. No. 337 012 DP.

Spare Globe, Cat. No. 201 DP WHT.

Spare Base with Socket Assembly, Cat. No. 1045 P00 DP.



Fig. 1631



WHITE ALL-ROUND LIGHTS

FOR USE ON POWER* DRIVEN VESSELS UNDER 20 METERS (65.6 ft.) IN LENGTH.

Stow-A-Way Plug-In Type

2 Mile Visibility

Complete With 12 Volt Bulb

3/4 Inch Diameter Anodized Aluminum Tubes,
Waterproof Cover For Bases

Fig. 1330 — Clear Fresnel Globe, Black Plastic Top, Chrome Plated Zinc Base

ORDERING INFORMATION

Vertical Height Inches	Display Pkg.-5 pcs. 1 Pc. per card	OEM Bulk Pkg. 50 pcs.	Weight Pounds
20 1/2	1330 DP2 CHR	1330 002 CHR	1
26 5/8	1330 DP3 CHR	1330 003 CHR	1 1/8
32 1/2	1330 DP4 CHR	1330 004 CHR	1 1/4

Base Length 3 3/4", Width 1 5/8", Screw Size #8.

Spare Bulbs (2 per card), Cat. No. 337 011 DP.

Spare Globe, Cat. No. 248 DP CLR.

Spare Base with Socket Assembly, Cat. No. 1059 P00 DP.

Fig. 1630 — White Translucent Globe, Black Plastic Top, Chrome Plated Zinc Base

* For Use On Sail or Power Driven Vessels

ORDERING INFORMATION

Vertical Height Inches	Display Pkg.-5 pcs. 1 Pc. per card	OEM Bulk Pkg. 50 pcs.	Weight Pounds
20 3/4	1630 DP2 CHR	1630 002 CHR	1
26 7/8	1630 DP3 CHR	1630 003 CHR	1 1/8
32 3/4	1630 DP4 CHR	1630 004 CHR	1 1/4
40	1630 DP5 CHR	1630 005 CHR	1 3/8
45 1/2	1630 DP6 CHR	1630 006 CHR	1 1/2
50 1/2	1630 DP7 CHR	1630 007 CHR	1 5/8

Base Length 3 3/4", Width 1 5/8", Screw Size #8.

Spare Bulbs (2 per card), Cat. No. 337 012 DP.

Spare Globe, Cat. No. 201 DP WHT.

Spare Base with Socket Assembly, Cat. No. 1059 P00 DP.

Fig. 1209 — Clear Fresnel Globe, Chrome Plated Brass Top and Base

ORDERING INFORMATION

Vertical Height Inches	Display Pkg.-5 pcs. 1 Pc. per card	OEM Bulk Pkg. 50 pcs.	Weight Pounds
21 3/8	1209 DP2 CHR	1209 002 CHR	1
28 3/8	1209 DP3 CHR	1209 003 CHR	1 1/4
34	1209 DP4 CHR	1209 004 CHR	1 1/2

Base Length 3 3/8", Width 2 1/4", Screw Size #8.

Spare Bulbs (2 per card), Cat. No. 337 011 DP.

Spare Bulb Socket, Cat. No. 24 DP2.

Spare Globe, Cat. No. 248 DP CLR.

Spare Cap for Base, Cat. No. 125 DP BLK.

Spare Base with Socket Assembly, Cat. No. 1209 DP 99A.



Fig. 1330



Fig. 1630



Fig. 1209



WHITE ALL-ROUND LIGHTS

FOR USE ON SAIL* OR POWER DRIVEN VESSELS UNDER 20 METERS (65.6 ft.) IN LENGTH.

Telescoping Type

2 Mile Visibility
Complete With 12 Volt Bulb
3/4 Inch Diameter Anodized Aluminum Tubes

Fig. 1311 — Clear Fresnel Globe, Black Plastic Top, Chrome Plated Zinc Base

* For Use on Power Driven Vessels Only.

ORDERING INFORMATION

Vertical Height Inches	Display Pkg.-5 pcs. 1 Pc. per card	OEM Bulk Pkg. 50 pcs.	Weight Pounds
20 1/2	1311 DP2 CHR	1311 002 CHR	7/8
26 5/8	1311 DP3 CHR	1311 003 CHR	1
32 1/2	1311 DP4 CHR	1311 004 CHR	1 1/8

Base Length 3 3/4", Width 1 5/8", Screw Size #8.

Spare Bulbs (2 per card), Cat. No. 337 011 DP. Spare Base, Cat. No. 1059 T00 DP.
 Spare Globe, Cat. No. 248 DP CLR.

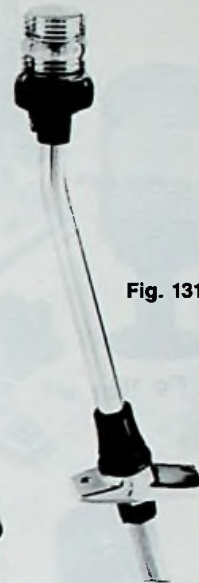

Fig. 1311



Fig. 1611 — White Translucent Globe, Black Plastic Top, Chrome Plated Zinc Base

ORDERING INFORMATION

Vertical Height Inches	Display Pkg.-5 pcs. 1 Pc. per card	OEM Bulk Pkg. 50 pcs.	Weight Pounds
20 3/4	1611 DP2 CHR	1611 002 CHR	7/8
26 7/8	1611 DP3 CHR	1611 003 CHR	1
32 3/4	1611 DP4 CHR	1611 004 CHR	1 1/8

Base Length 3 3/4", Width 1 5/8", Screw Size #8.

Spare Bulbs (2 per card), Cat. No. 337 012 DP. Spare Base, Cat. No. 1059 T00 DP.
 Spare Globe, Cat. No. 201 DP WHT.

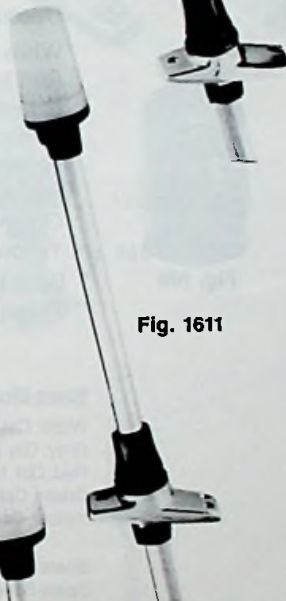

Fig. 1611



Fig. 1411 — White Translucent Globe, Black Plastic Top, Chrome Plated Zinc Base with Black Plastic Insert

ORDERING INFORMATION

Vertical Height Inches	Display Pkg.-5 pcs. 1 Pc. per card	OEM Bulk Pkg. 50 pcs.	Weight Pounds
21	1411 DP2 CHR	1411 002 CHR	7/8
27 1/4	1411 DP3 CHR	1411 003 CHR	1
33 1/2	1411 DP4 CHR	1411 004 CHR	1 1/8

Base Length 3 3/4", Width 1 3/4", Screw Size #8.

Spare Bulbs (2 per card), Cat. No. 337 012 DP. Spare Base, Cat. No. 1060 TB0 DP.
 Spare Globe, Cat. No. 201 DP WHT.

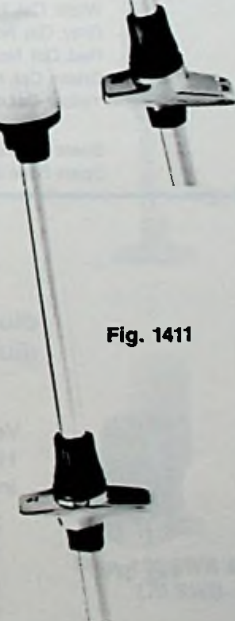

Fig. 1411



ALL-ROUND LIGHTS

FOR USE ON SAIL† OR POWER DRIVEN VESSELS UNDER 20 METERS (65.6 ft.) IN LENGTH.

2 Mile Visibility

Fig. 108 — Cast Zinc, Black PERKO·KOTE Finish
Festoon Type Electrical Socket

†For Power Driven Vessels Only.

Figs. 112 & 309 — Cast Bronze, Plain or Chrome Plated
Medium Screw Base Type Electrical Socket

For 12 or 32 Volts. Bulb Not Included.



Fig. 112



Fig. 309

Fig.	Height Overall Inches	O.D. Base Inches	Tapped Pipe Size Inches	Screw Size	Weight Pounds
108	6	3 1/8	1/2	10	2
112	8 3/4	3 1/8	---	8	2 1/2
309	6 1/2	----	1/2	---	2 1/4

ORDERING INFORMATION

Description	Plain Bronze Standard Pkg.-1 pc.	Chrome Plated Bronze Standard Pkg.-1 pc.	Black Powder Coat Zinc Display Pkg.-5 pcs. 1 Pc. per box	Black Powder Coat Zinc Standard Pkg.-1 pc.
	White All-Round	112 B00 PLB	112 B00 CHR	108 DP BLK**
Red All-Round	112 RB0 PLB	112 RB0 CHR	108 DPR BLK	108 R00 BLK
Green All-Round	112 GB0 PLB	112 GB0 CHR	108 DPG BLK	108 G00 BLK
Yellow All-Round	112 MB0 PLB	112 MB0 CHR	-----	-----
White All-Round	309 B00 PLB	309 B00 CHR		
Red All-Round	309 RB0 PLB	309 RB0 CHR		
Green All-Round	309 GB0 PLB	309 GB0 CHR		
Yellow All-Round	309 MB0 PLB	309 MB0 CHR		



Fig. 108



* Base Removable for Flush Mounting.
** These Lights Are Supplied with a Gray Tinted Globe.

SPARE PARTS ORDERING INFORMATION

Spare Globes:

White, Cat. No. 106 000 WHT.
Gray, Cat. No. 106 000 GRY.
Red, Cat. No. 106 000 RED.
Green, Cat. No. 106 000 GRN.
Yellow, Cat. No. 106 000 YLW.

Required Bulbs:

12 Volts for Fig. 108 (2 per card), Cat. No. 70 DP1 CLR.
12 Volts for White and Yellow Figs. 112 and 309, Cat. No. 340 005 FRD.
12 Volts for Red and Green Figs. 112 and 309, Cat. No. 340 006 FRD.
32 Volts for Fig. 108 (2 per card), Cat. No. 70 DP2 CLR.
32 Volts for White and Yellow Figs. 112 and 309, Cat. No. 340 011 FRD.
32 Volts for Red and Green Figs. 112 and 309, Cat. No. 340 012 FRD.

Spare Medium Screw Base Socket, Cat. No. 226.
Spare Base and Gasket for Fig. 108, Cat. No. 222 DP BLK.

Figs. 362 & 371 — Frosted Globe,
Cast Bronze, Plain or Chrome Plated

Double Contact Socket, Complete with 12 Volt Bulb.



Fig. 362



Fig. 371

ORDERING INFORMATION

Vertical Height Inches	O.D. Base Inches	Plain Bronze Display Pkg.-5 pcs. 1 Pc. per card	Chrome Plated Bronze Display Pkg.-5 pcs. 1 Pc. per card	Tapped Pipe Size Inches	Screw Size	Weight Ounces
		2 3/8	---			
1 5/8	2 1/2	371 DP PLB	371 DP CHR	8 F.H.	---	10

Spare Bulbs (2 per card), Cat. No. 337 011 DP.
Spare Socket, Cat. No. 24 DP1.

Spare Globe, Cat. No. 248 000 FRD.

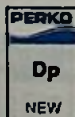

WHITE ALL-ROUND LIGHTS

FOR USE ON SAIL* OR POWER DRIVEN VESSELS UNDER 20 METERS (65.6 ft.) IN LENGTH.

2 Mile Visibility

Complete with 12 Volt or 24 Volt Bulb.

Black Plastic Tops, Chrome Plated Zinc Bases

3/4 Inch Anodized Aluminum Tubes

**Fig. 1134 — White Translucent Globe, Fold-Down Adjustable Angle, Horizontal Mount
Plastic Adapters for "V" or Flat Mount, 12 Volt Bulb**

**Fig. 1137 — White Translucent Globe, Fold-Down Adjustable Angle, Vertical Mount
Plastic Adapters for "V" or Flat Mount, 12 Volt Bulb**

Vertical Dimensions		ORDERING INFORMATION				
Height	Base	Display Pkg.	OEM Bulk Pkg.	Screw	Weight	
Inches	Inches	1 Pc. per card	50 pcs.	Size	Ounces	
13 5/8	2 x 1 1/2	1134 DP CHR	1134 000 CHR	8	13	
13 5/8	2 1/4 x 5/8	1137 DP CHR	1137 000 CHR	8	13	

Spare Bulbs (2 per card), Cat. No. 337 012 DP.

Spare Knob, Cat. No. 1144 A00 BLK.

Spare Globe, Cat. No. 201 DP WHT.

Spare Bracket with Knob and End Plug for Fig. No. 1134, Cat. No. 1052 DP CHR.

Spare Bracket with Knob and End Plug for Fig. No. 1137, Cat. No. 1054 DP CHR.

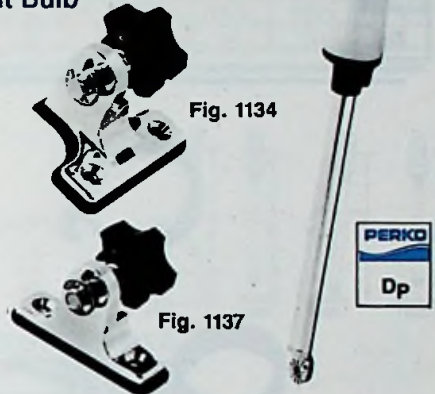

Fig. 1134

Fig. 1137



Fig. 455 — Clear Fresnel Globe, Fixed Mount,

12 Volt Bulb

*For Use on Power Driven Vessels Only

Vertical		ORDERING INFORMATION				
Height	O.D. Base	Display Pkg.	OEM Bulk Pkg.	Screw	Weight	
Inches	Inches	1 Pc. per card	50 pcs.	Size	Ounces	
4 1/2	2 1/16	455 DP1 CHR	455 001 CHR	8	12	
11	2 1/16	455 DP2 CHR	455 002 CHR	8	16	

Spare Bulbs (2 per card), Cat. No. 337 011 DP.

Spare Globe, Cat. No. 248 DP CLR.



Fig. 455



Fig. 1301 — White Translucent Globe, Fixed Mount,

12 Volt Bulb

Vertical Dimensions		ORDERING INFORMATION				
Height	Base	Display Pkg.	OEM Bulk Pkg.	Screw	Weight	
Inches	Inches	1 Pc. per card	50 pcs.	Size	Ounces	
7 1/8	1 x 2 5/8	1301 DP CHR	1301 000 CHR	8 R.H.	7	

Spare Bulbs (2 per card), Cat. No. 337 012 DP.

Spare Globe, Cat. No. 201 DP WHT.



Fig. 1301



Fig. 120 SWB — White Translucent Globe, Fixed Mount, 12 Volt Bulb

Fig. 170 SWB — White Translucent Globe, Fixed Mount, 24 Volt Bulb

Vertical Dimensions		ORDERING INFORMATION				
Height	Base	Display Pkg.	OEM Bulk Pkg.	Screw	Weight	
Inches	Inches	1 Pc. per card	50 pcs.	Size	Ounces	
3 3/4	1 x 2 5/8	120 SWB DP1	120 SWB 12V	8 R.H.	7	
3 3/4	1 x 2 5/8	170 SWB DP2	170 SWB 24V	8 R.H.	7	

Spare 12 Volt Bulbs (2 per card), Cat. No. 337 012 DP.

Spare Globe, Cat. No. 201 DP WHT.

Spare 24 Volt Bulb, Cat. No. 337 014 DP.



Figs. 120 SWB & 170 SWB





POLE STORAGE CLIPS FIG. 477



Fig. 477

Soft Rubber
Fits 3/4 Inch Diameter Tubing

ORDERING INFORMATION

Display Pkg.-10 pairs	OEM Bulk Pkg.	Screw Size	Weight per Pair Ounces
1 Pr. per card	50 pairs	8 P.H.	3
477 DP BLK	477 000 BLK		



Fig. 234

HALYARD EYES FIGS. 234 & 235

BLACK PLASTIC
Fits 3/4 Inch Diameter Tubing

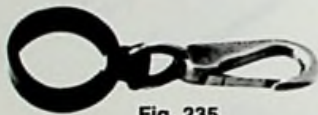
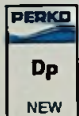

Fig. 235

Fig. 235 — Includes a Cat. No. 842 000 PLB Brass Snap

ORDERING INFORMATION

Display Pkg.-10 pcs.	Display Pkg.-10 pcs.
2 Pcs. per card	2 Pcs. per card
234 DP BLK	235 DP BLK



MOUNTING BRACKETS

FIG. 120

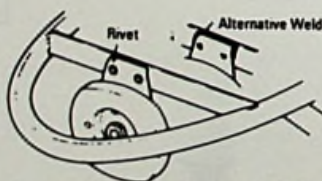

Typical Pulpit mounting Cat. No. 120 PB BKT

For Use With Figs. 120 and 170 Series Navigation Lights.

300 Series Stainless Steel
Black Plastic Mounting Plate

MAST MOUNTING
Cat. No. 120 VMB BKT

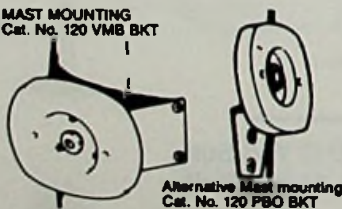

Alternative Mast mounting
Cat. No. 120 PBO BKT

ORDERING INFORMATION

Description	Standard Pkg.-1 pc.	Screw Size
Right Angle Bracket	120 RB BKT	8 R.H.
Masthead Bracket	120 VMB BKT	8 R.H.
Straight Pulpit Bracket	120 PB BKT	8 R.H.
Offset Mast Bracket	120 PBO BKT	8 R.H.

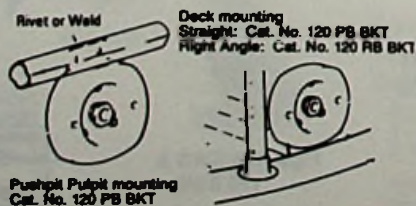

Pushpit Pulpit mounting
Cat. No. 120 PB BKT

Typical mounting for
Cruiser
Masthead Lantern
Cat. No.
120 RB BKT

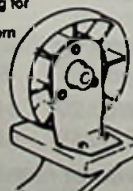

NAVIGATION LIGHT VERTICAL HEIGHTS

NOTE: Vertical Height "H" is Measured from the Center of the Bulb Filament to the Mounting Surface and May be Used as a Generalized Guide for the Selection of Lights in Accordance with the Vertical Light Separation Requirements of Navigation Regulations.

BI-COLOR LIGHTS

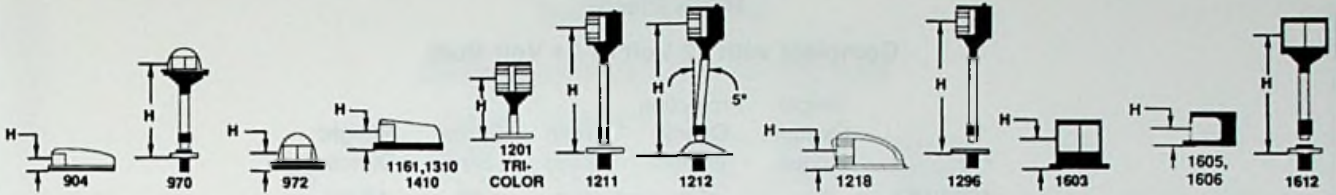

BI-COLOR LIGHTS

FIG.	904	970	972	1161	1201	1211	1212	1218	1296	1310	1410	1603	1605	1606	1612
H	7/8	9 3/4	7/8	1	3 1/4	10	10 1/4	1 5/8	10	1	1	1 1/8	5/8	5/8	9 3/4

WHITE ALL-ROUND LIGHTS

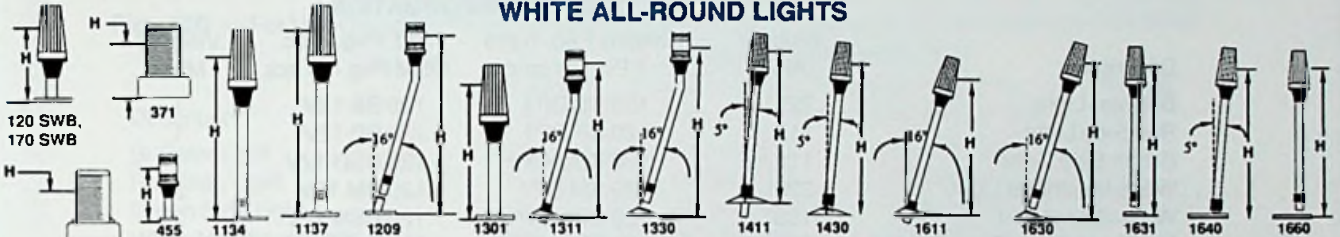

COMBINATION MASTHEAD AND WHITE ALL-ROUND LIGHTS

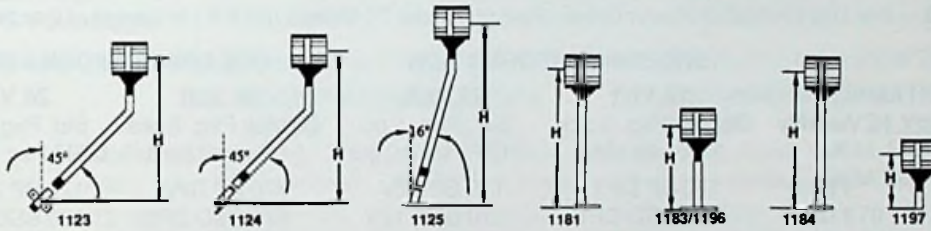

DIMENSIONS

SIZE	1	2	3	4	5	6	7
FIG.	H	H	H	H	H	H	H
WHITE ALL-ROUND LIGHTS							
120 SWB	3 3/4						
170 SWB	3 3/4						
362	2 3/8						
371	1 5/8						
455		4 1/2	11				
1134	13 5/8						
1137	13 5/8						
1209		21 3/8	28 3/8	34			
1301	7 1/8						
1311		20 1/2	26 5/8	32 1/2			
1330		20 1/2	26 5/8	32 1/2			
1411		21	27 1/4	33 1/2			
1430		21	27 1/4	33 1/2	40 3/4	46 3/4	51 3/4
1611		20 3/4	26 7/8	32 3/4			
1630		20 3/4	26 7/8	32 3/4	40	45 1/2	50 1/2
1631					40 1/4	46 3/4	51 3/4
1640		20 5/8	27 1/8	33 1/4	40 1/2	46 1/2	51 1/2
1660					40 5/8	46 5/8	51 3/8
COMBINATION MASTHEAD AND WHITE ALL-ROUND LIGHTS							
1123		11 1/2	20 3/4				
1124		11 1/2	20 3/4				
1125				33 5/8			
1181	12 5/8						
1183	3 1/4						
1184	12 5/8						
1196		5 1/4	11 1/4				
1197	4						

SIDE LIGHTS

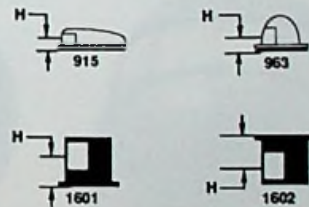

SIDE LIGHTS

FIG.	915	963	1601	1602
H	7/8	7/8	1 1/8	1 1/8

MASTHEAD LIGHTS

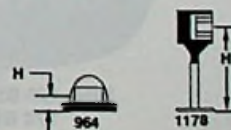

MASTHEAD LIGHTS

FIG.	964	1178
H	7/8	3 1/4



NAVIGATION LIGHTS

FOR USE ON SAIL OR POWER DRIVEN VESSELS AS SPECIFIED BELOW.

Black Plastic

Complete with 12 Volt or 24 Volt Bulb

Fig.	Height Overall Inches	Projection Overall Inches	Width Inches	Screw Size	Weight Ounces
120 BMD	7	4 3/4	4 1/8	10	18 1/2
All Others	3 5/8	2 1/2	4 1/8	10	5

Fig. 120 — For Use On Sail or Power Driven Vessels Under 12 Meters (39.4 ft.) In Length. (12 Volt Only)

ORDERING INFORMATION

Description	Visibility Arc	Display Pkg.-5 pcs. 1 Pc. per card	Std. Pkg.-1 pc. OEM Pkg.-10 pcs.	Visibility Miles
Bi-Color Light	225°	120 BB DP1	120 BB 12V	1
Red Side Light	112 1/2°	120 BP DP1	120 BP 12V	1
Green Side Light	112 1/2°	120 BSD DP1	120 BSD 12V	1
White Masthead Light	225°	120 BM DP1	120 BM 12V	2
White Stern Light	135°	120 BSN DP1	120 BSN 12V	2
Masthead/Deck Spreader Light	225°	120 BMD DP1	120 BMD 12V	2



Fig. 170 — For Use On Sail or Power Driven Vessels Under 20 Meters (65.6 ft.) In Length. (12 or 24 Volt)

ORDERING INFORMATION

ORDERING INFORMATION

Description	Visibility Arc	12 Volt		24 Volt		Visibility Miles
		Display Pkg.-5 pcs. 1 Pc. per card	Std. Pkg.-1 pc. OEM Pkg.-10 pcs.	Display Pkg.-5 pcs. 1 Pc. per card	Std. Pkg.-1 pc. OEM Pkg.-10 pcs.	
Red Side Light	112 1/2°	170 BP DP1	170 BP 12V	170 BP DP2	170 BP 24V	2
Green Side Light	112 1/2°	170 BSD DP1	170 BSD 12V	170 BSD DP2	170 BSD 24V	2
White Masthead Light	225°	170 BM DP1	170 BM 12V	170 BM DP2	170 BM 24V	3
White Stern Light	135°	170 BSN DP1	170 BSN 12V	170 BSN DP2	170 BSN 24V	2



Fig. 120 BB



**Figs. 120 BP &
170 BP**



**Figs. 120 BSD &
170 BSD**



**Figs. 120 BSN &
170 BSN**



**Figs. 120 BM &
170 BM**

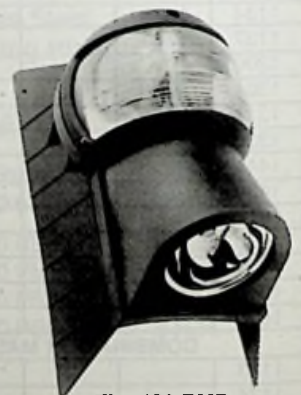

Fig. 120 BMD

SPARE PARTS ORDERING INFORMATION

Spare Halogen Bulb for Deck Spreader Light, Cat. No. 68 12V 20W.
Spare Bulbs (2 per card) for All Other 120s, Cat. No. 69 DP CLR.
Spare Bulbs (2 per card) for 170 BSN (12 Volt), Cat. No. 69 DP CLR.

Spare Bulbs (2 per card) for 170 BSN (24 Volt), Cat. No. 67 DP1 CLR.
Spare Bulbs (2 per card) for All Other 12 Volt 170s, Cat. No. 70 DP1 CLR.
Spare Bulbs (2 per card) for All Other 24 Volt 170s, Cat. No. 67 DP2 CLR.

For Spare Lens and Shield Assembly, Replace the Last Three Digits of the Catalog Number with the Letters "LNS" (e.g., 120 BB LNS, for a Black Shield and Bi-Color Lens).



NAVIGATION LIGHTS

FOR USE ON SAIL OR POWER DRIVEN VESSELS AS SPECIFIED BELOW.

**Chrome Plated Brass
Black Plastic Base**

Complete with 12 Volt or 24 Volt Bulb

Fig.	Height	Projection	Width Inches	Screw Size	Weight Ounces
	Overall Inches	Overall Inches			
120 SWB	5 1/8*	---	2 1/2	8 R.H.	4 1/2
170 SWB	5 1/8*	---	2 1/2	8 R.H.	4 1/2
All Others	3 5/8	2 1/2	4 1/8	10	5

*Vertical Height - 3 3/4 Inches.

Fig. 120 — For Use On Sail or Power Driven Vessels Under 12 Meters (39.4 ft.) In Length (12 Volt Only).

ORDERING INFORMATION

Description	Visibility	Display Pkg.-5 pcs.	Std. Pkg.-1 pc.	Visibility
	Arc	1 Pc. per card	OEM Pkg.-10 pcs.	Miles
Bi-Color Light	225°	120 MB DP1	120 MB 12V	1
Red Side Light	112 1/2°	120 MP DP1	120 MP 12V	1
Green Side Light	112 1/2°	120 MSD DP1	120 MSD 12V	1
White Masthead Light	225°	120 MM DP1	120 MM 12V	2
White Stern Light	135°	120 MSN DP1	120 MSN 12V	2
White All-Round Light	360°	120 SWB DP1	120 SWB 12V**	2

Fig. 170 — For Use On Sail or Power Driven Vessels Under 20 Meters (65.6 ft.) In Length (12 or 24 Volt).

ORDERING INFORMATION 12 Volt

ORDERING INFORMATION 24 Volt

Description	Visibility Arc	Display Pkg.-5 pcs.	Std. Pkg.-1 pc.	Display Pkg.-5 pcs.	Std. Pkg.-1 pc.	Visibility Miles
		1 Pc. per card	OEM Pkg.-10 pcs.	1 Pc. per card	OEM Pkg.-10 pcs.	
Red Side Light	112 1/2°	170 MP DP1	170 MP 12V	170 MP DP2	170 MP 24V	2
Green Side Light	112 1/2°	170 MSD DP1	170 MSD 12V	170 MSD DP2	170 MSD 24V	2
White Masthead Light	225°	170 MM DP1	170 MM 12V	170 MM DP2	170 MM 24V	3
White Stern Light	135°	170 MSN DP1	170 MSN 12V	170 MSN DP2	170 MSN 24V	2
White All-Round Light	360°	(SEE 120 SWB ABOVE)	(SEE 120 SWB ABOVE)	170 SWB DP2	170 SWB 24V**	2

**No Standard Pkg. Available, OEM Bulk Pkg.-50 pcs.



**Figs. 120 MSD &
170 MSD**



Fig. 120 MB



**Figs. 120 MP &
170 MP**



**Figs. 120 MSN &
170 MSN**



**Figs. 120 MM &
170 MM**



**Figs. 120 SWB &
170 SWB**

SPARE PARTS ORDERING INFORMATION

Spare Bulbs (2 per card) for 120 SWB, Cat. No. 337 012 DP.
Spare Bulb for 170 SWB (24 Volt), Cat. No. 337 014 DP.
Spare Bulbs (2 per card) for All Other 120s, Cat. No. 69 DP CLR.
Spare Bulbs (2 per card) for 170 MSN (12 Volt), Cat. No. 69 DP CLR.

Spare Bulbs (2 per card) for 170 MSN (24 Volt), Cat. No. 67 DP1 CLR.
Spare Bulbs (2 per card) for All Other 12 Volt 170s, Cat. No. 70 DP1 CLR.
Spare Bulbs (2 per card) for All Other 24 Volt 170s, Cat. No. 67 DP2 CLR.

For Spare Lens and Shield Assembly, Replace the Last Three Digits of the Catalog Number with the Letters "LNS" (e.g., 120 MB LNS for a Chrome Plated Brass Shield and Bi-Color Lens).





NAVIGATION LIGHTS

FOR USE ON SAIL OR POWER DRIVEN VESSELS AS SPECIFIED BELOW.

**White Plastic,
Black Plastic Base**

Complete with 12 Volt or 24 Volt Bulb

Height Overall Inches	Projection Overall Inches	Width Inches	Screw Size	Weight Ounces
3 5/8	2 1/2	4 1/8	10	5

Fig. 120 — For Use On Sail or Power Driven Vessels Under 12 Meters (39.4 ft.) In Length. (12 Volt Only)

ORDERING INFORMATION

Description	Visibility Arc	Display Pkg.-5 pcs. 1 Pc. per card	Std. Pkg.-1 pc. OEM Pkg.-10 pcs.	Visibility Miles
Bi-Color Light	225°	120 WB DP1	120 WB 12V	1
Red Side Light	112 1/2°	120 WP DP1	120 WP 12V	1
Green Side Light	112 1/2°	120 WSD DP1	120 WSD 12V	1
White Masthead Light	225°	120 WM DP1	120 WM 12V	2
White Stern Light	135°	120 WSN DP1	120 WSN 12V	2



Fig. 170 — For Use On Sail or Power Driven Vessels Under 20 Meters (65.6 ft.) In Length. (12 or 24 Volt)

ORDERING INFORMATION

ORDERING INFORMATION

Description	Visibility Arc	12 Volt		24 Volt		Visibility Miles
		Display Pkg.-5 pcs. 1 Pc. per card	Std. Pkg.-1 pc. OEM Pkg.-10 pcs.	Display Pkg.-5 pcs. 1 Pc. per card	Std. Pkg.-1 pc. OEM Pkg.-10 pcs.	
Red Side Light	112 1/2°	170 WP DP1	170 WP 12V	170 WP DP2	170 WP 24V	2
Green Side Light	112 1/2°	170 WSD DP1	170 WSD 12V	170 WSD DP2	170 WSD 24V	2
White Masthead Light	225°	170 WM DP1	170 WM 12V	170 WM DP2	170 WM 24V	3
White Stern Light	135°	170 WSN DP1	170 WSN 12V	170 WSN DP2	170 WSN 24V	2



**Figs. 120 WSD &
170 WSD**

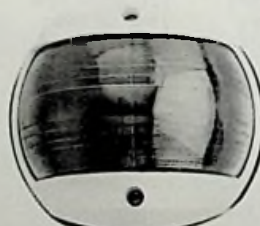

Fig. 120 WB



**Figs. 120 WP &
170 WP**



**Figs. 120 WM &
170 WM**



**Figs. 120 WSN &
170 WSN**

SPARE PARTS ORDERING INFORMATION

Spare Bulbs (2 per card) for All 120s, Cat. No. 69 DP CLR.

Spare Bulbs (2 per card) for 170 WSN (12 Volt), Cat. No. 69 DP CLR.

Spare Bulbs (2 per card) for 170 WSN (24 Volt), Cat. No. 67 DP1 CLR.

Spare Bulbs (2 per card) for All Other 12 Volt 170s, Cat. No. 70 DP1 CLR.

Spare Bulbs (2 per card) for All Other 24 Volt 170s, Cat. No. 67 DP2 CLR.

For Spare Lens and Shield Assembly, Replace the Last Three Digits of the Catalog Number with the Letters "LNS" (e.g., 120 WB LNS, for a White Shield and Bi-Color Lens).



NAVIGATION LIGHTS

FOR USE ON SAIL OR POWER DRIVEN VESSELS UNDER 20 METERS (65.6 ft.) IN LENGTH.

Top Mount Black Plastic with Stainless Steel Mounting Bracket Complete with 12, 24 or 32 Volt Bulb

Height Overall Inches	Projection Inches	Height Lens Inches	Screw Size	Weight Ounces
4 13/16	3 5/16	2 3/4	8	12 1/2

ORDERING INFORMATION — For 12 Volt Lights

Description	Visibility Arc	Display Pkg.-5 pcs. 1 Pc. per pkg.	Std. Pkg.-1 pc. OEM Pkg.-10 pcs.	Visibility Miles	Replacement Bulb
Bi-Color Light	225°	200 BT DP1	200 BT 12V	2	375 12V 25W
Red Side Light	112 1/2°	200 PT DP1	200 PT 12V	2	375 12V 25W
Green Side Light	112 1/2°	200 SDT DP1	200 SDT 12V	2	375 12V 25W
White Masthead Light	225°	200 MT DP1	200 MT 12V	3	375 12V 25W
White Stern Light	135°	200 SNT DP1	200 SNT 12V	2	375 12V 10W
Yellow Towing Light	135°	200 TWT DP1	200 TWT 12V	2	375 12V 10W

ORDERING INFORMATION — For 24 Volt Lights

Replace the "DP1" with "DP2" For Display Package or the "12V" with "24V" For Standard Package or OEM Package (e.g., 200 BT DP2 or 200 BT 24V).
For the Replacement Bulb, Replace the "12V" with "24V" (e.g., 375 24V 25W).

ORDERING INFORMATION — For 32 Volt Lights

Replace the "DP1" with "DP3" For Display Package or the "12V" with "32V" For Standard Package or OEM Package (e.g., 200 BT DP3 or 200 BT 32V).
For the Replacement Bulb, Replace the "12V" with "32V" (e.g., 375 32V 25W).



200 SERIES TOP MOUNT

SPARE LENS ORDERING INFORMATION

Spare Lens Assembly Part Numbers are Determined by Replacing the Last Three Digits of the Catalog Number with the Letters "LNS" (e.g., 200 BT LNS, for a Bi-Color Top Mount Lens Assembly).



NAVIGATION LIGHTS

FOR USE ON SAIL OR POWER DRIVEN VESSELS UNDER 20 METERS (65.6 ft.) IN LENGTH.

**Base Mount
Black Plastic**

Complete with 12, 24 or 32 Volt Bulb

Height Overall Inches	O.D. Base Inches	Height Lens Inches	Screw Size	Weight Ounces
4 7/8	3 5/16	2 3/4	10	9 1/2

ORDERING INFORMATION — For 12 Volt Lights

Description	Visibility Arc	Display Pkg.-5 pcs. 1 Pc. per pkg.	Std. Pkg.-1 pc. OEM Pkg.-10 pcs.	Visibility Miles	Replacement Bulb
Bi-Color Light	225°	200 BB DP1	200 BB 12V	2	375 12V 25W
Red Side Light	112 1/2°	200 PB DP1	200 PB 12V	2	375 12V 25W
Green Side Light	112 1/2°	200 SDB DP1	200 SDB 12V	2	375 12V 25W
White Masthead Light	225°	200 MB DP1	200 MB 12V	3	375 12V 25W
White Stern Light	135°	200 SNB DP1	200 SNB 12V	2	375 12V 10W
Yellow Towing Light	135°	200 TWB DP1	200 TWB 12V	2	375 12V 10W
White All-Round Light	360°	200 SWB DP1	200 SWB 12V	2	375 12V 10W
Red All-Round Light	360°	200 SRB DP1	200 SRB 12V	2	375 12V 25W
Green All-Round Light	360°	200 SGB DP1	200 SGB 12V	2	375 12V 25W
Tri-Color Light*	360°	200 TB DP1	200 TB 12V	2	375 12V 25W

* For Use on Vessels Under Sail Alone.



ORDERING INFORMATION — For 24 Volt Lights

Replace the "DP1" with "DP2" For Display Package or the "12V" with "24V" For Standard Package or OEM Package (e.g., 200 BB DP2 or 200 BB 24V). For the Replacement Bulb, Replace the "12V" with "24V" (e.g., 375 24V 25W and 375 24V 10W).

ORDERING INFORMATION — For 32 Volt Lights

Replace the "DP1" with "DP3" For Display Package or the "12V" with "32V" For Standard Package or OEM Package (e.g., 200 BB DP3 or 200 BB 32V). For the Replacement Bulb, Replace the "12V" with "32V" (e.g., 375 32V 25W and 375 32V 10W).

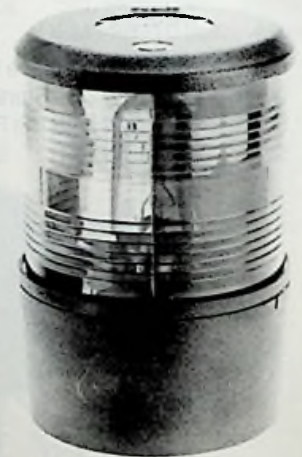

SPARE LENS ORDERING INFORMATION

Spare Lens Assembly Part Numbers are Determined by Replacing the Last Three Digits of the Catalog Number with the Letters "LNS" (e.g., 200 BB LNS, for a Bi-Color Base Mount Lens Assembly).

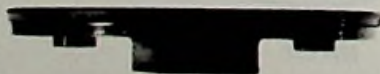

Fig. 222

PIPE MOUNTING BRACKET

FIG. 222

**Cast Zinc with Gloss Black PERKO-KOTE Finish
Complete with Screws and Soft Black Mounting Gasket
for Mounting Bracket to Light.**

For Use on All 200 Series Base Mount Lights.

ORDERING INFORMATION

O.D. Overall Inches	Tapped Pipe Size Inches	Display Pkg.-5 pcs. 1 Pc. per bag
3 5/16	1/2	222 DP BLK



ALL-ROUND LIGHTS

FOR USE ON SAIL OR POWER DRIVEN VESSELS UNDER 20 METERS (65.6 ft.) IN LENGTH.



Halyard Mount
Black Plastic with Stainless Steel Mounting Hardware.
Complete with 12, 24 or 32 Volt Bulb

Height Overall	O.D.	Height Lens	Weight
Inches	Inches	Inches	Ounces
7 1/8	3 5/16	2 3/4	9

ORDERING INFORMATION — For 12 Volt Lights

Description	Display Pkg.-5 pcs. 1 Pc. per pkg.	Std. Pkg.-1 pc. OEM Pkg.-10 pcs.	Visibility Miles	Replacement Bulb
White All-Round Light	200 SWH DP1	200 SWH 12V	2	375 12V 10W
Red All-Round Light	200 SRH DP1	200 SRH 12V	2	375 12V 25W
Green All-Round Light	200 SGH DP1	200 SGH 12V	2	375 12V 25W

ORDERING INFORMATION — For 24 Volt Lights

Replace the "DP1" with "DP2" For Display Package or the "12V" with "24V" For Standard Package or OEM Package (e.g., 200 SWH DP2 or 200 SWH 24V).
 For the Replacement Bulb, Replace the "12V" with "24V" (e.g., 375 24V 25W).

ORDERING INFORMATION — For 32 Volt Lights

Replace the "DP1" with "DP3" For Display Package or the "12V" with "32V" For Standard Package or OEM Package (e.g., 200 SWH DP3 or 200 SWH 32V).
 For the Replacement Bulb, Replace the "12V" with "32V" (e.g., 375 32V 25W).



Fig. 200 SWH



Fig. 200 SRH



200 SGH

SPARE LENS ORDERING INFORMATION

Spare Lens Assembly Part Numbers are Determined by Replacing the Last Three Digits of the Catalog Number with the Letters "LNS"
 (e.g., 200 SWH LNS, for a White Halyard Mount Lens Assembly).

RAIL MOUNTING BRACKET FIG. 200M

300 Series Stainless Steel
Complete with Screws for Mounting Light to Bracket.

ORDERING INFORMATION

For Rail O.D.	Standard	Weight
Inches	Pkg.-1 pc.	Ounces
3/4 - 1	200 M STS	5 1/2

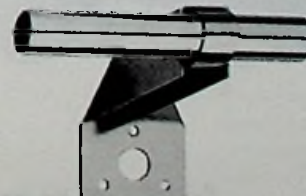

Fig. 200M



DUAL PURPOSE ALL-ROUND LIGHTS

FOR USE ON SAIL OR POWER DRIVEN VESSELS UNDER 20 METERS (65.6 ft.) IN LENGTH.

**Base Mount
Black Plastic**

Complete with Two 12, 24 or 32 Volt Bulbs

Height Overall Inches	O.D. Base Inches	Height Lens Inches	Screw Size	Weight Ounces
8 5/8	3 5/16	2 3/4	10	14

ORDERING INFORMATION — For 12 Volt Lights

Description	Display Pkg.-5 pcs. 1 Pc. per pkg.	Std. Pkg.-1 pc. OEM Pkg.-10 pcs.	Visibility Miles	Replacement Bulbs
Tri-Color/White All-Round Light*	200 TAB DP1	200 TAB 12V	2/2	375 12V 25W/10W
Masthead/White All-Round Light	200 MAB DP1	200 MAB 12V	3/2	375 12V 25W/10W
Green/Red All-Round Light	200 GRB DP1	200 GRB 12V	2/2	375 12V 25W/25W

* For Use on Vessels Under Sail Power Alone.



Fig. 200 MAB

ORDERING INFORMATION — For 24 Volt Lights

Replace the "DP1" with "DP2" For Display Pkg. or the "12V" with "24V" For Standard Pkg. or OEM Pkg. (e.g., 200 TAB DP2 or 200 TAB 24V).

For the Replacement Bulbs, Replace the "12V" with "24V" (e.g., 375 24V 25W and 375 24V 10W).

ORDERING INFORMATION — For 32 Volt Lights

Replace the "DP1" with "DP3" For Display Pkg. or the "12V" with "32V" For Standard Pkg. or OEM Pkg. (e.g., 200 TAB DP3 or 200 TAB 32V).

For the Replacement Bulbs, Replace the "12V" with "32V" (e.g., 375 32V 25W and 375 32V 10W).

NOTE: The Above Lights are Used with Other Lights, Therefore Both Compartments Are Never to be Illuminated at the Same Time.



Fig. 200 TAB

SPARE LENS ORDERING INFORMATION

Spare Lens Part Numbers are Determined by Replacing the Last Three Figures of the Catalog Number With the Letters "LNS" (i.e., 200 TAB LNS, for a Tri-Color/White All-Round Lens).

MEAL AND ABSENT LIGHT FIG. 329

**Chrome Plated Bronze
Double Contact Bayonet Sockets, Bulbs Not Included**



Fig. 329

Blue Owner Absent Light and White Mealtime Light,
Replace Blue and White Flags for Use at Night.
For Mounting on Main Starboard Yardarm.

ORDERING INFORMATION

Dimensions Base Inches	Length Overall Inches	O.D. Globe Inches	Standard Pkg.-1 pc.	Screw Size	Weight Pounds
3 3/8 x 1 3/4	9	2 1/2	329 000 CHR	8	2

Required Bulbs (2 per card) For 12 Volt Use, Cat. No. 337 011 DP.
Required Bulbs (1 per card) For 32 Volt Use, Cat. No. 337 018 DP.
Spare Socket, Cat No. 24 DP1.

Spare Blue Globe, Cat. No. 250 000 BLU.
Spare White Globe, Cat No. 250 000 WHT.



NAVIGATION LIGHTS

FOR USE ON SAIL OR POWER DRIVEN VESSELS UNDER 20 METERS (65.6 ft.) IN LENGTH.

**Cast Zinc with Gloss Black PERKO-KOTE Finish
For 12 or 32 Volts, Bulb Not Included**

Fig.	Height Overall Inches	Height Lens Inches	Tapped Pipe Size	Screw Size	Weight Pounds
108	6	5	1/2"	10	1 3/4
All Others	5 1/4	4 1/4	---	10	2

ORDERING INFORMATION

Description	Visibility Arc	Display Pkg.-5 pcs. 1 Pc. per card	Standard Pkg.-1 pc.	Visibility Miles
Side Lights (Pair)	112 1/2°	109 DP BLK	109 000 BLK	2
Red Side Light	112 1/2°	109 DPR BLK	109 R00 BLK	2
Green Side Light	112 1/2°	109 DPG BLK	109 G00 BLK	2
White Masthead Light	225°	110 DP BLK	110 000 BLK	3
White Stern Light	135°	111 DP BLK	111 000 BLK	2
Yellow Towing Light	135°	111 DPM BLK	111 M00 BLK	2
White All-Round Light**	360°	108 DP BLK	108 000 BLK	2
Red All-Round Light	360°	108 DPR BLK	108 R00 BLK	2
Green All-Round Light	360°	108 DPG BLK	108 G00 BLK	2

* Base Removable for Flush Mounting.

** This Light is Supplied with a Gray Tinted Globe.



Fig. 109



Fig. 109



Fig. 108



Fig. 110



Fig. 111

SPARE PARTS ORDERING INFORMATION

Spare Lenses:

112 1/2° Fig. No. 259 H02, Specify Color.
135° Fig. No. 269 H02, Specify Color.
225° Cat. No. 256 H02 WHT.
360° Fig. No. 106 000, Specify Color.

Required Bulbs:

For 12 Volts (2 per card), Cat. No. 70 DP1 CLR.
For 32 Volts (2 per card), Cat. No. 70 DP2 CLR.
Spare Base and Gasket for Fig. No. 108, Cat. No. 222 DP BLK

NAVIGATION LIGHTS

FOR USE ON POWER DRIVEN VESSELS AS SPECIFIED BELOW.

**Sheet metal, Galvanized Steel or Polished Brass
Bottom Opening, Complete with Mounting Bracket,
For 12 or 32 Volts, Bulb Not Included**

	Height Overall Inches	Height Lens Inches	Screw Size	Weight Pounds
For Vessels Under 12 Meters (39.4 ft.)	5	4 1/4	6	1 1/2
For Vessels 12 to 20 Meters (65.6 ft.)	6	5 1/8	6	2

ORDERING INFORMATION

For Vessels Under 12 meters (39.4 ft) in Length (12 Volts Only).

Description	Visibility Arc	Galvanized Steel	Polished Brass	Visibility Miles
Side Lights (Pair)	112 1/2°	91 F02 GAL	91 F02 POL	1
Red Side Light	112 1/2°	91 RF2 GAL	91 RF2 POL	1
Green Side Light	112 1/2°	91 GF2 GAL	91 GF2 POL	1
White Masthead Light	225°	98 F02 GAL	98 F02 POL	2
White Stern Light	135°	99 F02 GAL	99 F02 POL	2

ORDERING INFORMATION

For Vessels 12 Meters (39.4 ft.) to 20 Meters (65.6 ft.) in Length (12 or 32 Volts).

Description	Visibility Arc	Galvanized Steel	Polished Brass	Visibility Miles
Side Lights (Pair)	112 1/2°	91 F03 GAL	91 F03 POL	2
Red Side Light	112 1/2°	91 RF3 GAL	91 RF3 POL	2
Green Side Light	112 1/2°	91 GF3 GAL	91 GF3 POL	2
White Masthead Light	225°	98 F03 GAL	98 F03 POL	3
White Stern Light	135°	99 F03 GAL	99 F03 POL	2



Fig. 91



Fig. 98



Fig. 99

SPARE PARTS ORDERING INFORMATION

Spare Lenses:

112 1/2° Fig. No. 259 CL2 or CL3, Specify Color.
135° Fig. No. 269 CL2 or CL3, Specify Color.
225° Fig. No. 256 CL2 or CL3, Specify Color.
Spare Mounting Bracket, Cat. No. 92 000 GAL or PLB.
Spare Electric Adapter for No. 2, Cat. No. 138 F02.
Spare Electric Adapter for No. 3, Cat. No. 138 F03.

Required Bulbs:

Bulbs for No. 2 (12 volts-2 per card), Cat. No. 70 DP0 CLR.
Bulbs for No. 3 (12 volts-2 per card), Cat. No. 70 DP1 CLR.
Bulbs for No. 3 (32 volts-2 per card), Cat. No. 70 DP2 CLR.

NAVIGATION LIGHTS

FOR USE ON POWER DRIVEN VESSELS AS SPECIFIED BELOW.

**Sheet metal, Galvanized Steel or Polished Brass
Bottom Opening, Complete with Mounting Bracket,
For 12 or 32 Volts, Bulb Not Included**

	Height Overall Inches	Height Lens Inches	Screw Size	Weight Pounds
For Vessels Under 12 Meters (39.4 ft.)	7 1/4	4 1/4	10	2 1/2
For Vessels 12 to 20 Meters (65.6 ft.)	8 1/2	5 1/8	10	3 1/2

ORDERING INFORMATION

For Vessels Under 12 meters (39.4 ft) in Length (12 Volts Only).

Description	Visibility Arc	Galvanized Steel	Polished Brass	Visibility Miles
Side Lights (Pair)	112 1/2°	4 F02 GAL	4 F02 POL	1
Red Side Light	112 1/2°	4 RF2 GAL	4 RF2 POL	1
Green Side Light	112 1/2°	4 GF2 GAL	4 GF2 POL	1
White Masthead Light	225°	5 F02 GAL	5 F02 POL	2
White Stern Light	135°	7 F02 GAL	7 F02 POL	2

ORDERING INFORMATION

For Vessels 12 Meters (39.4 ft.) to 20 Meters (65.6 ft.) in Length (12 or 32 Volts).

Description	Visibility Arc	Galvanized Steel	Polished Brass	Visibility Miles
Side Lights (Pair)	112 1/2°	4 F03 GAL	4 F03 POL	2
Red Side Light	112 1/2°	4 RF3 GAL	4 RF3 POL	2
Green Side Light	112 1/2°	4 GF3 GAL	4 GF3 POL	2
White Masthead Light	225°	5 F03 GAL	5 F03 POL	3
White Stern Light	135°	7 F03 GAL	7 F03 POL	2
Yellow Towing Light	135°	7 MF3 GAL	7 MF3 POL	2



Fig. 7F
Fig. 7MF



Fig. 4F



Fig. 5F
Fig. 5MF

SPARE PARTS ORDERING INFORMATION

Spare Lenses:

112 1/2° Fig. No. 259 CL2 or CL3, Specify Color.

135° Fig. No. 269 CL2 or CL3, Specify Color.

225° Cat. No. 256 CL2 WHT or 256 CL3 WHT.

Spare Mounting Bracket, Cat. No. 131 000 GAL or PLB.

Spare Electric Adapter for No. 2, Cat. No. 290 F02.

Spare Electric Adapter for No. 3, Cat. No. 290 F03.

Required Bulbs:

Bulbs for No. 2 (12 volts-2 per card), Cat. No. 70 DP0 CLR.

Bulbs for No. 3 (12 volts-2 per card), Cat. No. 70 DP1 CLR.

Bulbs for No. 3 (32 volts-2 per card), Cat. No. 70 DP2 CLR.

NAVIGATION LIGHTS

FOR USE ON POWER DRIVEN VESSELS 20 METERS (65.6 ft.) TO 50 METERS (164.0 ft.) IN LENGTH.

BLACK PLASTIC

Complete with Pre-Wired Double Contact Socket and
3 Feet of 16/3-SJO Cable, For 12, 24, 32 or 120 Volts.
Watertight Access Cap for Rebulbing and Cleaning.
Bulb Not Included.

Height Overall Inches	Height Lens Inches	Screw Size	Weight Pounds
7 1/2	4 1/2	1/4	3 1/8

ORDERING INFORMATION

Description	Visibility Arc	Visibility Miles	Cat. No.
Red Side Light	112 1/2°	2	1127 RA0 BLK
Green Side Light	112 1/2°	2	1127 GA0 BLK
White Masthead Light	225°	5	1128 A00 BLK
White Stern Light*	135°	2	1129 A00 BLK
Yellow Towing Light	135°	2	1129 MA0 BLK
White All-Round Light*	360°	2	1130 A00 BLK
White All-Round Light**	360°	5	1130 HA0 BLK
Red All-Round Light	360°	2	1130 RA0 BLK
Green All-Round Light	360°	2	1130 GA0 BLK
Yellow All-Round Light	360°	2	1130 MA0 BLK

* These lights are supplied with a Gray Tinted Lens.

** For Great Lakes use.



Fig. 1127



Fig. 1128



Fig. 1129



Fig. 1130

IMPORTANT BULB DATA

To comply with U.L. Standard 1104, the lights listed on this page must use a PERKO Fig. No. 374 bulb.

SPARE PARTS ORDERING INFORMATION

Spare Lens Assemblies:

Red, Cat. No. 249 000 RED.
Green, Cat. No. 249 000 GRN.
White, Cat. No. 249 000 CLR.
Gray, Cat. No. 249 000 GRY.
Yellow, Cat. No. 249 000 YLW.

Spare Double Contact Socket, Cat. No. 134.
Spare Access Cap, O-Ring and Retainer, Cat. No. 1105 000 BLK.
Spare O-Ring for Cap, Cat. No. 1119.

Required Bulbs:

12 Volts, Cat. No. 374 001 CLR.
24 Volts, Cat. No. 374 002 CLR.
32 Volts, Cat. No. 374 003 CLR.
120 Volts, Cat. No. 374 004 CLR.

NAVIGATION LIGHTS

FOR USE ON SAIL* OR POWER DRIVEN VESSELS UNDER 20 METERS (65.6 ft.) IN LENGTH.

Oil or Electric

Sheet metal, Galvanized Steel or Polished Brass

Bottom Opening, Complete with Oil Fount or Electric Socket and Mounting Bracket. Bulb Not Included

Oil Lights For Emergency Use Only.

Fig.	Height	Height	Screw Size	Weight Pounds
	Overall Inches	Lens Inches		
06	11 3/4	4 1/4	---	4 1/4
All Others	12 1/2	5 1/8	10	3 1/2

ORDERING INFORMATION

Description	Visibility Arc	Galvanized Steel	Polished Brass	Electric Light
				Visibility Miles
Side Lights (Pair)	112 1/2°	19 000 GAL	19 000 POL	2
Red Side Light	112 1/2°	19 R00GAL	19 R00 POL	2
Green Side Light	112 1/2°	19 G00 GAL	19 G00 POL	2
White Masthead Light	225°	20 000 GAL	20 000 POL	3
White Stern Light	135°	102 000 GAL	102 000 POL	2
Yellow Towing Light	135°	102 M00 GAL	102 M00 POL	2
White All-Round Light	360°	06 000 GAL	06 000 POL	2
White All-Round Light - Electric**	360°	06 A00 GAL	06 A00 POL	2
White All-Round Light - Electric***	360°	06 B00 GAL	06 B00 POL	2

* NOTE: All of the Above Lights (Except Fig. 06) May Be Ordered For Electric Use on Power Driven Vessels Only. Specify by Replacing the first "0" in the Center Group of the Catalog Number with an "F" (e.g., 19 F00 POL, for an Electric Polished Brass Pair of Side Lights).

** With Double Contact Bayonet Electrical Socket.

*** With Medium Screw Base Electrical Socket.



Fig. 19



Fig. 20



Fig. 102



Fig. 06

SPARE PARTS ORDERING INFORMATION

Spare Lenses:

112 1/2° Fig. No. 259 CL3, Specify Color.
 135° Fig. No. 269 CL3, Specify Color.
 225° Cat. No. 256 CL3 WHT.
 360° Cat. No. 261SR0 CLR (Oil) or Cat. No. 261 SR0 FRD (Electric).
 Spare Mounting Bracket, Cat. No. 131 000 GAL or PLB.
 Spare Electric Adapter for Fig. 06A, Cat. No. 291 003 PLB.
 Spare Electric Adapter for Fig. 06B, Cat. No. 292 000 PLB.
 Spare Electric Adapter for All Others, Cat. No. 290 F03.

Required Bulbs for Electric Use:

Bulbs For Fig. 06A (2 per card), Cat. No. 337 012 DP.
 Bulb For Fig. 06B, Cat. No. 340 005 FRD.
 Bulbs for All Other 12 Volt Lights (2 per card), Cat. No. 70 DP1 CLR.
 Bulbs for All Other 32 Volt Lights (2 per card), Cat. No. 70 DP2 CLR.
 Spare Burner For Fig. No. 06, Cat. No. 231 000 PLB.
 Spare Burner For All Others, Cat. No. 246 000 PLB.
 Spare Wick For All, Cat. No. 302 00A
 Spare Oil Fount For All, Cat. No. 286 000 PLB.
 Spare Chimney for Fig. No. 06, Cat. No. 230 000 CLR.

SPARE BASES FOR PERKO POLE LIGHTS

Figs. 1045, 1059-P & 1060-P — Plug-In Type, Waterproof Snap-On Cover



Fig. 1045 P00



Fig. 1059 P00



Fig. 1060 PB0



Fig. 1045 P00 — Fits Figs. 940, 970, 1211*, 1612 & 1631 Series

Fig. 1059 P00 — Fits Figs. 1330 & 1630 Series

Fig. 1060 PB0 — Fits Figs. 1212*, 1430 Series

Locking Collar is Included with Base To Allow Interchangeability with Discontinued Style Bases.

Length Overall Inches	Width Overall Inches	Insert Type	ORDERING INFORMATION		Tube Angle Degrees
			Replaces Cat. No.	Display Pkg.-5 pcs. 1 Pc. per card	
2 1/4 O.D.	----	None	1023 P00 CHR	1045 P00 DP	0
3 3/4	1 5/8	None	1330 000 99A	1059 P00 DP	16
3 3/4	1 5/8	None	1026 P00 CHR	1059 P00 DP	16
3 3/4	1 3/4	Black	1027 PB0 CHR	1060 PB0 DP	5
3 3/4	1 3/4	Teak**	1027 PT0 CHR	1060 PB0 DP	5

* Specify 3-Contact Base (eg. 1045 300 DP for Fig. No. 1211 or 1060 3B0 DP for Fig. No. 1212)

** Teak Insert Bases No Longer Available, Substitute Black Insert Bases.

Figs. 1059-T & 1060-T — Telescoping Type



Fig. 1059 T00



Fig. 1060 T00



Fig. 1059 T00 — Fits Fig. 1311 & 1611 Series

Fig. 1060 TB0 — Fits Fig. 1411 Series

Locking Collar is Included with Base To Allow Interchangeability with Discontinued Style Bases.

Length Overall Inches	Width Overall Inches	Insert Type	ORDERING INFORMATION		Tube Angle Degrees
			Replaces Cat. No.	Display Pkg.-5 pcs. 1 Pc. per card	
3 3/4	1 5/8	None	1156 000 CHR	1059 T00 DP	16
3 3/4	1 5/8	None	1026 T00 CHR	1059 T00 DP	16
3 3/4	1 3/4	Black	1027 TB0 CHR	1060 TB0 DP	5
3 3/4	1 3/4	Teak	1027 TT0 CHR	1060 TB0 DP	5

Figs. 1046 & 1047 — Plug-In Type, Water Resistant Slide Cover

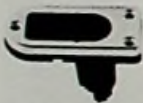

Fig. 1046

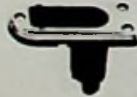

Fig. 1047



Fig. 1046 P00 — Fits Fig. 1640 Series

Fig. 1047 P00 — Fits Figs. 1296* & 1660 Series

Length Overall Inches	Width Overall Inches	ORDERING INFORMATION		Tube Angle Degrees
		Display Pkg.-5 pcs. 1 Pc. per card		
3 1/2	1 1/2	1047 P00 DP		0
3 1/2	1 1/2	1046 P00 DP		5

* Specify 3-Contact Base, Cat. No. 1047 3B0 DP.

Figs. 1125-99A & 1209-99A — Plug-In Type, Waterproof Screw-On Cap

Fig. 1125-99A — Fits Fig. 1125

Fig. 1209-99A — Fits Fig. 1209 Series



Figs. 1125-99A
& 1209-99A

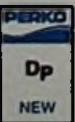

Length Overall Inches	Width Overall Inches	ORDERING INFORMATION		Tube Angle Degrees
		Display Pkg.-5 pcs. 1 Pc. per card		
3 3/8	2 1/4	1125 DP 99A		16
3 3/8	2 1/4	1209 DP 99A		16

WHITE ALL-ROUND LIGHTS

FOR USE ON SAIL OR POWER DRIVEN VESSELS UNDER 20 METERS (65.6 ft.) IN LENGTH.

Replacement Stow-A-Way Plug-In Type

2 Mile Visibility

White Translucent Globe, Black Plastic Top, Complete With 12 Volt Bulb
3/4 Inch Diameter Anodized Aluminum Tubes, Bases Not Included

Fig. 1400 — Universal Replacement

Approx. Length Inches	ORDERING INFORMATION	
	Display Pkg.-10 pcs. 1 Pc. per card	Weight Pounds
24	1400 DP2 CHR	1/2
30	1400 DP3 CHR	5/8
36	1400 DP4 CHR	1 1/2
42	1400 DP5 CHR	1 3/4
48	1400 DP6 CHR	2
54	1400 DP7 CHR	2 1/4

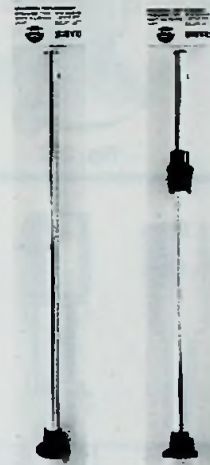

Fig. 1600 — Replacement PERKO Lights with Locking Collar

Approx. Length Inches	ORDERING INFORMATION	
	Display Pkg.-10 pcs. 1 Pc. per card	Weight Pounds
24	1600 DP2 CHR	1/2
30	1600 DP3 CHR	5/8
36	1600 DP4 CHR	1 1/2
42	1600 DP5 CHR	1 3/4
48	1600 DP6 CHR	2
54	1600 DP7 CHR	2 1/4

Fig. 1400 Fig. 1600

SPARE BRACKETS FOR PERKO WINDSHIELD MOUNT LIGHTS

Figs. 1052 & 1054 — Fold-Down, Adjustable Angle With Plastic Adapters for "V" or Flat Mount

Fig. 1052 — Horizontal Mount, Fits Figs. 1134 & 1181

Fig. 1054 — Vertical Mount, Fits Figs. 1137 & 1184

Complete with Knob and End Plug.

Length Overall Inches	Width Overall Inches	ORDERING INFORMATION	
		Replaces Cat. No.	Display Pkg.-5 pcs. 1 Pc. per card
2	1 1/2	1120 000 CHR	1052 DP CHR
2 1/4	5/8	1122 000 CHR	1054 DP CHR



Fig. 1052



Fig. 1054



Figs. 1123-99A & 1124-99A — Plug-In Type, Waterproof Screw-On Cap With Plastic Adapters for "V" or Flat Mount

Fig. 1123 — Horizontal Mount, Fits Fig. 1123 Series

Fig. 1124 — Vertical Mount, Fits Fig. 1124 Series

Dimensions		ORDERING INFORMATION	
Bracket Inches		Display Pkg.-5 pcs. 1 Pc. per card	
2 1/4 x 3/4		1123 DP 99A	
3/4 x 2 1/4		1124 DP 99A	



Fig. 1123-99A



Fig. 1124-99A



SPARE PARTS

FOR NAVIGATION LIGHTS ON VESSELS UNDER 20 METERS (65.6 ft.) IN LENGTH

ELECTRIC ADAPTERS FIGS. 138, 290, 291 & 292

Figs. 138 & 290 — Brass Spring Type For Double Ended Bulbs

Fig. 291 — For Double Contact Bayonet Base Bulb

Fig. 292 — For Medium Screw Base Bulb



Fig. 138



Fig. 290



Fig. 291



Fig. 292

O.D. Overall Inches	I.D. Light Opening Inches	Height Overall Inches	Standard Pkg.-1 pc.
2 3/16	1 7/8	3 1/2	138 F02
2 3/16	1 7/8	3 3/4	138 F03
4 1/2	3 3/16	4 3/4	290 F02
4 1/2	3 3/16	5 1/4	290 F03
3 5/8	3 3/16	2 5/8	291 003 PLB
3 5/8	3 3/16	2 1/8	292 000 PLB



Fig. 52



Fig. 276

DOUBLE CONTACT BAYONET SOCKETS FIGS. 52 & 276

Brass, with 6 Inch Wire Leads — Fig. 276 Tapped for 1/8 Inch Pipe.

Length Overall Inches	Standard Pkg.-5 pcs.	Display Pkg.-10 bags 1 Pc. per bag
1	-----	52 DP
1 1/2	276 000	
2	276 002	
2 3/8	276 003	
3	276 004	



DOUBLE CONTACT BAYONET SOCKET FIG. 24

Black Plastic Body — Brass Spring



Fig. 24

Length Pigtail Inches	O.D. Inches	Display Pkg.-10 bags 1 Pc. per bag
10	3/4	24 DP1
60	3/4	24 DP2

SINGLE CONTACT BAYONET SOCKET FIG. 1109

Brass



Fig. 1109

Length Pigtail Inches	Length Socket Inches	O.D. Inches	Display Pkg.-10 bags 1 Pc. per bag
6	5/8	3/8	1109 DP



Fig. 286

OIL FOUNT FIG. 286

Brass

O.D. Overall Inches	I.D. Light Opening Inches	Standard Pkg.-1 pc.
3 5/8	3 3/16	286 000 PLB



Fig. 231



Fig. 246



Fig. 302

OIL BURNERS AND WICKS FIGS. 231, 246 & 302

Brass

O.D. Thread Inches	Plain Standard Pkg. -5 pcs.	Chrome Plated Standard Pkg. -5 pcs.	Width Wick Inches	Wick Standard Pkg. -20 pcs.
13/16	231 000 PLB	231 000 CHR	3/8	302 00A
13/16	246 000 PLB	-----	3/8	302 00A



Fig. 230

LAMP CHIMNEY FIG. 230

Glass

O.D. Base Inches	Height Overall Inches	Standard Pkg.-5 pcs.
1 1/2	4 3/4	230 000 CLR

SPARE PARTS

FOR NAVIGATION LIGHTS ON VESSELS UNDER 20 METERS (65.6 ft.) IN LENGTH

DOUBLE CONTACT BAYONET BASE BULB FIG. 337

Nominal Voltage	Wattage	Amps	Display Pkg. 5 cards	Bulbs per card	Bulb Diameter Inches	Mfr. Lamp No.
12	7	.58	337 011 DP	2	3/4	90
12	11	.94	337 012 DP	2	3/4	1004
12	17	1.44	337 013 DP	2	1	1142
24	15	.63	337 014 DP	1	1	306
32	12	.37	337 018 DP	1	3/4	624
32	14	.45	337 019 DP	1	1	1228
32	20	.61	337 020 DP	1	1	1692
32	24	.74	337 021 DP	1	1 1/8	1054
120	15	---	337 023 DP	2	7/8	15T7



Fig. 337



DOUBLE CONTACT BAYONET BASE BULB FIG. 374

Nominal Voltage	Wattage	Amps	Standard Pkg.-1 bulb
12	30	2.5	374 001 CLR
24	30	1.25	374 002 CLR
32	30	.94	374 003 CLR
120	30	.25	374 004 CLR



Fig. 374

DOUBLE CONTACT BAYONET INDEXING BASE BULB FIG. 375

Nominal Voltage	Wattage	Amps	Standard Pkg.-1 bulb
12	10	.83	375 12V 10W
12	25	2.08	375 12V 25W
24	10	.42	375 24V 10W
24	25	1.04	375 24V 25W
32	10	.31	375 32V 10W
32	25	.78	375 32V 25W



Fig. 375

MEDIUM SCREW BASE BULB FIG. 340

Nominal Voltage	Wattage	Amps	Standard Pkg.- 6 bulbs	Type	L.C.L. Inches	Mfr. Lamp No.
12	15	1.25	340 005 FRD	A-17	2 3/8	15-A
12	25	2.08	340 006 FRD	A-19	2 9/16	25-A
12	50	4.16	340 007 FRD	A-21	3 7/16	50-A21
32	15	.47	340 011 FRD	A-17	2 3/8	15-A
32	25	.78	*340 012 FRD	A-19	2 9/16	25-A
32	50	1.56	*340 013 FRD	A-21	3 7/16	50-A21

*Standard Pkg.- 2 bulbs



Fig. 340



DOUBLE ENDED - FESTOON BULBS FIGS. 67, 69, 70, 71 & 72

Nominal Voltage	Wattage	Amps	Display Pkg.-5 cards 2 Bulbs per card	Bulb Diameter Inches	Bulb Length Inches
12	10	.83	69 DP CLR	3/8	1 5/8
12	10	.74	70 DP0 CLR	3/8	1 11/16
12	13	.97	70 DP1 CLR	9/16	1 11/16
12	10	.80	71 DP CLR	3/8	1 1/8
24	10	.42	67 DP1 CLR	3/8	1 11/16
24	18	.75	67 DP2 CLR	9/16	1 11/16
24	10	.40	72 DP1 CLR	3/8	1 1/8
32	13	.40	70 DP2 CLR	3/8	1 5/8

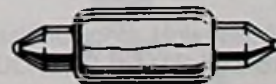

Fig. 67
Fig. 69
Fig. 70
Fig. 71
Fig. 72



SPARE PARTS

FOR NAVIGATION LIGHTS ON VESSELS UNDER 20 METERS (65.6 ft.) IN LENGTH.



Fig. 283



Fig. 296



Fig. 281



Fig. 74



Fig. 284



Fig. 106



Fig. 268



Fig. 259



Fig. 260



Fig. 256



Fig. 278



Fig. 281



Fig. 269



Fig. 261



Fig. 248F



Fig. 289

112 1/2° LENSES FOR BI-COLOR / TRI-COLOR LIGHTS

Color	Height Inches	Width Inches	Display Pkg.-5 cards 1 Set per card
Red/Green	1	1 3/4	283 DPA LNS
Red/Green	1 1/4	1 3/8	296 DP LNS
Red/Green	2 1/2	2	259 DPA LNS
Red/Green	1 1/2	1	268 DP LNS
Red/Green	1	1 3/4	* 289 DPA LNS

* One Piece Lens.

112 1/2° LENSES FOR SIDE LIGHTS

Color	Height Inches	Width Inches	Display Pkg.-5 cards 1 Set per card	Std. Pkg.-1 pc.
Red/Green	1	1 9/16	281 DPA LNS*	-----
Red/Green	1 1/4	---	260 DP LNS*	-----
Red	4 1/4	3 1/16	-----	259 CL2 RED
Green	4 1/4	3 1/16	-----	259 CL2 GRN
Red	5 1/16	3 11/16	-----	259 CL3 RED
Green	5 1/16	3 11/16	-----	259 CL3 GRN

* Set of 1 Red and 1 Green Lens.

225° LENSES FOR MASTHEAD LIGHTS

Color	Height Inches	I.D. Inches	O.D. Inches	Display Pkg.-5 cards 1 Pc. per card	Std. Pkg.-1 pc.
White	1	1 9/16	2 3/16	281 DPA WHT	-----
White	1 1/2	1	1 1/4	278 DP WHT*	-----
White	4 1/4	3 3/8	---	-----	256 CL2 WHT
White	5 1/8	3 1/4	---	-----	256 CL3 WHT

* Display Pkg., 5 cards - 2 Pcs. per card.

135° LENSES FOR STERN LIGHTS

Color	Height Inches	I.D. Inches	O.D. Inches	Display Pkg.-5 cards 1 Pc. per card	Std. Pkg.-1 pc.
White	1 1/4	1 9/16	2 3/16	74 DP WHT	-----
White	1 1/2	1	1 1/4	278 DP WHT*	-----
White	1 1/4	1 9/16	2 3/16	281 DPA WHT	-----
Clear	---	---	2	284 DP CLR**	-----
White	4 1/4	3 1/2	---	-----	269 CL2 WHT
White	5 1/8	3 5/8	---	-----	269 CL3 WHT
Yellow	4 1/4	3 1/2	---	-----	269 CL2 YLW
Yellow	5 1/8	3 5/8	---	-----	269 CL3 YLW

* Display Pkg., 5 cards - 2 Pcs. per card.

** Includes Gasket.

360° LENSES FOR ALL-ROUND LIGHTS

Color	Height Inches	I.D. Inches	O.D. Inches	Std. Pkg.-1 pc.
Red	5	2 7/8	3 1/4	106 000 RED
Green	5	2 7/8	3 1/4	106 000 GRN
White	5	2 7/8	3 1/4	106 000 WHT
Yellow	5	2 7/8	3 1/4	106 000 YLW
Gray	5	2 7/8	3 1/4	106 000 GRY
White	3	1 1/2	1 9/16	201 DP WHT*
Clear	2 1/2	1 11/16	2	248 DP CLR*
Frosted	2 1/2	1 11/16	2	248 000 FRD
Clear	3 5/16	3 3/16	---	261 JR0 CLR
Frosted	3 5/16	3 3/16	---	261 JR0 FRD
Clear	4 1/4	4	---	261 SR0 CLR
Frosted	4 1/4	4	---	261 SR0 FRD

* Display Pkg., 5 cards - 1 Pc. per card.

U.S. COAST GUARD REGULATIONS FOR NAVIGATION LIGHTS ON VESSELS OVER 20 METERS (65.6 ft.) IN LENGTH

On March 31, 1977, the U.S. Coast Guard published in the Federal Register, an amendment to the navigation and navigable water regulations, which added a new subchapter DD, (33CFR 87). This subchapter contains rules implementing and interpreting the International Regulations for Preventing Collisions at Sea, 1972 (72 COLREGS). The International Regulations for Preventing Collisions at Sea, 1960, were replaced by the 72 COLREGS at 1200 hours, zone time on July 15, 1977. Therefore, all vessels on the high seas must comply with the 72 COLREGS at this time. In addition, with the enactment of the U.S. Inland Navigation Rules Act of 1980, the Inland Rules, Western Rules, and Great Lakes Rules were unified into a single set of requirements. The effective date for this legislation was December 24, 1981 (March 1, 1983 for Great Lakes). Therefore, all vessels must comply with these rules at this time.

Rules 21 and 22 of the 72 COLREGS and the U.S. Inland Navigation Rules give the color and range requirements for various navigation lights. Annex 1 to the 72 COLREGS and the U.S. Inland Navigation Rules gives positioning and technical details for these lights.

U.S. COAST GUARD ACCEPTANCE OF NAVIGATION LIGHTS

All U.S. Registered vessels are subject to either the 72 COLREGS or the U.S. Inland Rules. The U.S. Coast Guard is accepting lights that have passed the U.L. tests (U.L. Standard 1104) as meeting the 72 COLREGS and the U.S. Inland Rules for vessels over 20 meters (65.6 ft.) in length. U.S. requirements for smaller vessels are less strict. As the first domestic manufacturer to pass U.L. 1104, PERKO's lights can be installed on vessels over 20 meters (65.6 ft.) in length. Some models are designed for use on vessels over 20 meters (65.6 ft.) in length, while others are designed for use on vessels 20 meters (65.6 ft.) to 50 meters (164.0 ft.) in length.

A brass tag is permanently affixed to the light indicating the type of light, figure no., voltage and bulb type to install to meet the visibility requirements. It also states that the light is classified by U.L. in accordance with the 72 COLREGS. This is the only documentation needed by a vessel for navigation lights to certify light construction compliance with the 72 COLREGS and the Inland Navigation Rules, and eliminates the former "Certificate of Compliance".

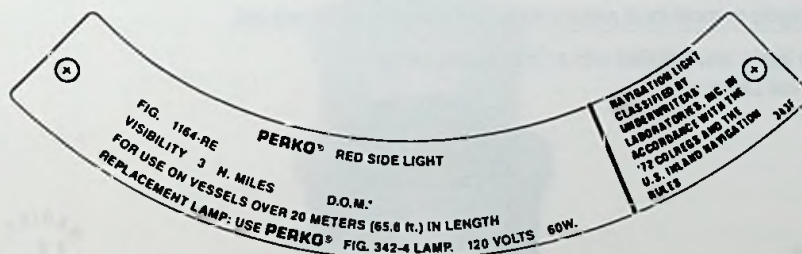

*Each light has its own serial no. for identification.

The lights indicated for use on vessels over 20 meters (65.6 ft.) in length have passed U.L. 1104. The facsimile of the tag shown above is used on our cast bronze lights. Similar rectangular tags are used on other style lights.

Please note that any changes made to PERKO Navigation lights, including substitution of bulbs other than those shown in our catalog, instruction sheets, or metal tags (affixed to some lights) will void all certifications and U.S. Coast Guard acceptance.

For the present, the U.S. Coast Guard will not publish a list of U.L. classified lights. However, field offices have been notified. For more detailed information, consult the complete 72 COLREGS, the U.S. Inland Navigation Rules, and your local U.S. Coast Guard office.

SPECIAL PURPOSE LIGHTS

Other lights (not shown) for use where the vessel is subject to special local requirements are available. Contact PERKO for further information.

SINGLE LENS NAVIGATION LIGHTS

FOR USE ON VESSELS OVER 20 METERS (65.6 FT.) IN LENGTH

CAST BRONZE

Complete with a Pre-Wired Medium Prefocus Socket and
3 Feet of 16/3-SO Cable through a watertight terminal tube.
Watertight access cap for rebulbing and cleaning.
120 Volt Bulb Included.

Height Overall Inches	Height Lens Inches	Weight Pounds	Mounting Bolt Size Inches
9¼	6¾	11½	¾

ORDERING INFORMATION

Description	Visibility Arc	Visibility Miles	Cat. No.
Red Side Light	112½°	3	1172 REO PLB
Green Side Light	112½°	3	1172 GEO PLB
White Masthead Light	225°	6	1173 EOO PLB
White Stern Light*	135°	3	1174 EOO PLB
Yellow Towing Light	135°	3	1174 MEO PLB
White All-Round Light*	360°	3	1169 EOO PLB
White All-Round Light**	360°	6	1169 HEO PLB
Red All-Round Light	360°	3	1170 REO PLB
Green All-Round Light	360°	3	1170 GEO PLB
Yellow All-Round Light	360°	3	1170 MEO PLB

Special lights to meet local requirements are available upon request.

*These lights are supplied with a Gray Tinted Lens.

**For Great Lakes use.



IMPORTANT BULB DATA

To comply with U.L. Standard 1104, the lights listed on this page must use a PERKO Cat. No. 342 004 CLR bulb.

SPARE PARTS ORDERING INFORMATION

Spare Lenses:

Red, Cat. No. 261 001 RED
Green, Cat. No. 261 001 GRN
White, Cat. No. 261 001 CLR
Gray, Cat. No. 261 001 GRY
Yellow, Cat. No. 261 001 YLW

Spare Lens Gasket, Cat. No. 1143.
Spare O-Ring for Cap, Cat. No. 1119.
Spare Medium Prefocus Socket, Cat. No. 347.
Spare Lens Retaining Clip with Bolt, Cat. No. 1133.
Spare Access Cap, O-Ring and Retainer, Cat. No. 1105 000 BLK.

DOUBLE LENS NAVIGATION LIGHTS

FOR USE ON VESSELS OVER 20 METERS (65.6 FT.) IN LENGTH

CAST BRONZE

Each compartment contains a Pre-Wired Medium Prefocus Bulb Socket with 3 Feet of 16/3-SO Cable through a watertight terminal tube.
 Watertight access cap for rebulbing and cleaning.
 120 Volt Bulbs Included.

Height Overall Inches	Height Lens Inches	Weight Pounds	Mounting Bolt Size Inches
17¼	6¾	22 ⁵ / ₈	¾

ORDERING INFORMATION

Description	Visibility Arc	Visibility Miles	Cat. No.
Red Side Light	112½°	3	1164 REO PLB
Green Side Light	112½°	3	1164 GEO PLB
White Masthead Light	225°	6	1165 EOO PLB
White Stern Light*	135°	3	1166 EOO PLB
Yellow Towing Light	135°	3	1166 MEO PLB
White All-Round Light*	360°	3	1167 EOO PLB
White All-Round Light**	360°	6	1167 HEO PLB
Red All-Round Light	360°	3	1168 REO PLB
Green All-Round Light	360°	3	1168 GEO PLB
Yellow All-Round Light	360°	3	1168 MEO PLB

Special lights to meet local requirements are available upon request.

*These lights are supplied with a Gray Tinted Lens.

**For Great Lakes use.



IMPORTANT BULB DATA

To comply with U.L. Standard 1104, the lights listed on this page must use PERKO Cat. No. 342 004 CLR bulbs.

SPARE PARTS ORDERING INFORMATION

Spare Lenses:

Red, Cat. No. 261 001 RED
 Green, Cat. No. 261 001 GRN
 White, Cat. No. 261 001 CLR
 Gray, Cat. No. 261 001 GRY
 Yellow, Cat. No. 261 001 YLW

Spare O-Ring for Cap, Cat. No. 1119.
 Spare Lens Gasket, Cat. No. 1143.
 Spare Lens Retaining Clip with Bolt, Cat. No. 1133.
 Spare Dual Medium Prefocus Socket Assembly, Cat. No. 303.
 Spare Plastic Cap, O-Ring and Retainer, Cat. No. 1105 000 BLK.

NAVIGATION LIGHTS

FOR USE ON VESSEL LENGTHS AS SPECIFIED BELOW

**Sheet metal; Galvanized Steel*, Plain or Polished Brass.
Complete with a Medium Prefocus Socket and a
watertight terminal tube for 16/3-SO cable.
Watertight access cap for rebulbing and cleaning.
120 Volt Bulb Not Included.**

Size No.	Height Overall Inches	Height Lens Inches	Weight Pounds
1	11½	6¾	6⅝
2	13½	7½	10⅞

ORDERING INFORMATION For Use On Vessels 20 Meters (65.6 ft.) to 50 Meters (164.0 ft.) In Length



Description	Galv. Steel*	Plain Brass	Polished Brass	Visibility Arc	Visibility Miles	Required Bulb
Red Side Light	1150 RE1 GAL	1150 RE1 PLB	1150 RE1 POL	112½°	2	342 002 CLF
Green Side Light	1150 GE1 GAL	1150 GE1 PLB	1150 GE1 POL	112½°	2	342 002 CLF
White Masthead Light	1151 EO1 GAL	1151 EO1 PLB	1151 EO1 POL	225°	5	342 003 CLF
White Stern Light	1152 EO1 GAL	1152 EO1 PLB	1152 EO1 POL	135°	2	342 000 CLF
Yellow Towing Light	1152 ME1 GAL	1152 ME1 PLB	1152 ME1 POL	135°	2	342 000 CLF
White All-Round Light	1153 EO1 GAL	1153 EO1 PLB	1153 EO1 POL	360°	2	342 001 CLF
Red All-Round Light	1154 RE1 GAL	1154 RE1 PLB	1154 RE1 POL	360°	2	342 004 CLF
Green All-Round Light	1154 GE1 GAL	1154 GE1 PLB	1154 GE1 POL	360°	2	342 003 CLF
Yellow All-Round Light	1154 ME1 GAL	1154 ME1 PLB	1154 ME1 POL	360°	2	342 002 CLF



Figs. 1153 & 1154

ORDERING INFORMATION For Use On Vessels Over 20 Meters (65.6 ft.) In Length.

Description	Galv. Steel*	Plain Brass	Polished Brass	Visibility Arc	Visibility Miles	Required Bulb
Red Side Light	1150 RE2 GAL	1150 RE2 PLB	1150 RE2 POL	112½°	3	342 004 CLF
Green Side Light	1150 GE2 GAL	1150 GE2 PLB	1150 GE2 POL	112½°	3	342 004 CLF
White Masthead Light	1151 EO2 GAL	1151 EO2 PLB	1151 EO2 POL	225°	6	342 004 CLF
White Stern Light	1152 EO2 GAL	1152 EO2 PLB	1152 EO2 POL	135°	3	342 002 CLF
Yellow Towing Light	1152 ME2 GAL	1152 ME2 PLB	1152 ME2 POL	135°	3	342 002 CLF
White All-Round Light	1153 EO2 GAL	1153 EO2 PLB	1153 EO2 POL	360°	3	342 003 CLF
Red All-Round Light	1154 RE2 GAL	1154 RE2 PLB	1154 RE2 POL	360°	3	342 006 CLF
Green All-Round Light	1154 GE2 GAL	1154 GE2 PLB	1154 GE2 POL	360°	3	342 004 CLF
Yellow All-Round Light	1154 ME2 GAL	1154 ME2 PLB	1154 ME2 POL	360°	3	342 003 CLF

*Galvanized Steel Lights are Preprimed.



Fig. 1151



Fig. 1150



Fig. 1152

IMPORTANT BULB DATA

To comply with U.L. Standard 1104, the lights listed on this page must use a PERKO Fig. No. 342 bulb.

Spare Lenses:

112½°	Cat. No. 259 No. 1 or 2, Specify Color
135°	Cat. No. 269 No. 1 or 2, Specify Color
225°	Cat. No. 256 No. 1 or 2, Specify Color
360°	Cat. No. 281F No. 1 or 2, Specify Color

SPARE PARTS ORDERING INFORMATION

Spare Medium Prefocus Socket, Cat. No. 347 A00.
Spare Access Cap, O-Ring and Retainer, Cat. No. 1105 000 BLK.
Spare O-Ring for Cap, Cat. No. 1119.

NAVIGATION LIGHTS

FOR USE ON VESSELS 20 METERS (65.6 FT.) TO 50 METERS (164.0 FT.) IN LENGTH

BLACK PLASTIC

Complete with Pre-Wired Double Contact Socket and
3 Feet of 16/3-SJO Cable For 12, 24, 32 or 120 Volts.
Watertight access cap for rebulbing and cleaning.
Bulb Not Included.

Height Overall Inches	Height Lens Inches	Screw Size	Weight Pounds
7½	4½	¼	3⅝

ORDERING INFORMATION

Description	Visibility Arc	Visibility Miles	Cat. No.
Red Side Light	112½°	2	1127 RAO BLK
Green Side Light	112½°	2	1127 GAO BLK
White Masthead Light	225°	5	1128 AOO BLK
White Stern Light*	135°	2	1129 AOO BLK
Yellow Towing Light	135°	2	1129 MAO BLK
White All-Round Light*	360°	2	1130 AOO BLK
White All-Round Light**	360°	5	1130 HAO BLK
Red All-Round Light	360°	2	1130 RAO BLK
Green All-Round Light	360°	2	1130 GAO BLK
Yellow All-Round Light	360°	2	1130 MAO BLK



**All-Round
Lights
360 Degrees**

*These lights are supplied with a Gray Tinted Lens.

**For Great Lakes use.



**Stern or
Towing Lights
135 Degrees**



**Masthead Lights
225 Degrees**



**Red & Green
Side Lights
112½ Degrees**

IMPORTANT BULB DATA

To comply with U.L. Standard 1104, the lights listed on this page must use a PERKO Fig. No. 374 bulb.

SPARE PARTS ORDERING INFORMATION

Spare Lens Assemblies:

Red, Cat. No. 249 000 RED.
Green, Cat. No. 249 000 GRN.
White, Cat. No. 249 000 CLR.
Gray, Cat. No. 249 000 GRY.
Yellow, Cat. No. 249 000 YLW.

Spare Double Contact Socket, Cat. No. 134.
Spare Access Cap, O-Ring and
Retainer, Cat. No. 1105 000 BLK.
Spare O-Ring for Cap, Cat. No. 1119.

Required Bulbs:

12 Volts, Cat. No. 374 001 CLR.
24 Volts, Cat. No. 374 002 CLR.
32 Volts, Cat. No. 374 003 CLR.
120 Volts, Cat. No. 374 004 CLR.

NAVIGATION LIGHTS

FOR USE ON VESSELS 20 METERS (65.6 FT.) TO 50 METERS (164.0 FT.) IN LENGTH

Sheet metal; Galvanized Steel*, Polished or Chrome Plated Brass.
Bottom Opening, Complete with Mounting Bracket
and Single Contact Prefocus Socket for
12 Volt Use Only. Bulb Not Included.

Height Overall Inches	Height Lens Inches	Weight Pounds
8½	5⅝	2½

ORDERING INFORMATION

Description	Galvanized Steel*	Polished Brass	Chrome Plated Brass	Visibility Arc	Visibility Miles	Required Bulb
Red Side Light	4 RD3 GAL	4 RD3 POL	4 RD3 CHR	112½°	2	373 003 CLR
Green Side Light	4 GD3 GAL	4 GD3 POL	4 GD3 CHR	112½°	2	373 002 CLR
White Masthead Light	5 DO3 GAL	5 DO3 POL	5 DO3 CHR	225°	5	373 005 CLR
White Stern Light	7 DO3 GAL	7 DO3 POL	7 DO3 CHR	135°	2	373 001 CLR
Yellow Towing Light	7 MD3 GAL	7 MD3 POL	7 MD3 CHR	135°	2	373 002 CLR

*Galvanized Steel Lights are Preprimed.



Figs. 7 & 7M



Fig. 4



Fig. 5



IMPORTANT BULB DATA

To comply with U.L. Standard 1104, the lights listed on this page must use a PERKO Fig. No. 373 bulb.

SPARE PARTS ORDERING INFORMATION

Spare Lenses:

Red	112½°	Cat. No. 259 CL3 RED.
Green	112½°	Cat. No. 259 CL3 GRN.
White	135°	Cat. No. 269 CL3 WHT.
Yellow	135°	Cat. No. 269 CL3 YLW.
White	225°	Cat. No. 256 CL3 WHT.

Spare Mounting Bracket; Cat. No. 131 000, GAL or PLB.
Spare Single Contact Prefocus Socket Assembly, Complete with Stand, Bottom Plate and Gasket, Cat. No. 294 003 PLB.

ALL-ROUND LIGHTS

FOR USE ON VESSELS OVER 20 METERS (65.6 FT.) IN LENGTH

CAST BRONZE

Complete with Medium Prefocus Socket and 120 Volt Bulb.

Fig. No.	Height Overall Inches	Height Lens Inches	Tapped Pipe Size Inches	Weight Pounds	Visibility Miles
403	11½	6¾	1	8¼	3
412	14	6¾	*	8¼	3



Fig. 403-3

ORDERING INFORMATION

	White	Red	Green	Yellow
Fig. No. 403	403 EO3 PLB**	403 RE3 PLB	403 GE3 PLB	403 ME3 PLB
Fig. No. 412	412 EOO PLB**	412 REO PLB	412 GEO PLB	412 MEO PLB

*Supplied with watertight terminal tube for 16/3-SO cable.

**These Lights are Supplied with Gray Tinted Lenses.

IMPORTANT BULB DATA

To comply with U.L. Standard 1104, the lights above must use a PERKO Cat. No. 342 004 CLR bulb.

SPARE PARTS ORDERING INFORMATION

Spare Lenses:

Gray, Cat. No. 261 001 GRY.
 Red, Cat. No. 261 001 RED.
 Green, Cat. No. 261 001 GRN.
 Yellow, Cat. No. 261 001 YLW.

Spare Lens or Cover Gasket, Cat. No. 1143.
 Spare Medium Prefocus Socket, Cat. No. 347.



Fig. 412

ALL-ROUND LIGHTS

FOR USE ON VESSELS 20 METERS (65.6 FT.) TO 50 METERS (164.0 FT.) IN LENGTH

CAST BRONZE

Plain or Chrome Plated. Complete with Double Contact Electrical Socket for 12, 24, 32 or 120 Volts. Bulb Not Included.

Fig. No.	Height Overall Inches	Diameter Base Inches	Tapped Pipe Size Inches	Weight Pounds	Visibility Miles
112	8¾	3⅞	—	2½	2
309	6½	—	½	2¼	2

ORDERING INFORMATION

Description	Plain Bronze	Chrome Plated Bronze
White All-Round	112 AOO PLB	112 AOO CHR
Red All-Round	112 RAO PLB	112 RAO CHR
Green All-Round	112 GAO PLB	112 GAO CHR
Yellow All-Round	112 MAO PLB	112 MAO CHR

ORDERING INFORMATION

Description	Plain Bronze	Chrome Plated Bronze
White All-Round	309 AOO PLB	309 AOO CHR
Red All-Round	309 RAO PLB	309 RAO CHR
Green All-Round	309 GAO PLB	309 GAO CHR
Yellow All-Round	309 MAO PLB	309 MAO CHR



Fig. 112A



IMPORTANT BULB DATA

To comply with U.L. Standard 1104, the lights listed above must use a PERKO Fig. No. 374 bulb.

SPARE PARTS ORDERING INFORMATION

Spare Globes:

Red, Cat. No. 106 000 RED.
 Green, Cat. No. 106 000 GRN.
 White, Cat. No. 106 000 WHT.
 Yellow, Cat. No. 106 000 YLW.
 Spare Double Contact Bayonet Socket, Cat. No. 276 002.

Required Bulbs:

12 Volts, Cat. No. 374 001 CLR.
 24 Volts, Cat. No. 374 002 CLR.
 32 Volts, Cat. No. 374 003 CLR.
 120 Volts, Cat. No. 374 004 CLR.



Fig. 309A

SPECIAL FLASHING YELLOW BARGE LIGHT FIG. 1111ME FOR USE ON VESSELS OF ANY LENGTH



Fig. 1111ME

Sheet metal; Galvanized Steel* or Plain Brass. Complete with Medium Prefocus Socket and watertight terminal tube for 16/3-SO cable. Sealed Flasher Unit, Watertight access cap for rebulbing and cleaning. 120 Volt Bulb Not Included.

Designed to meet Federal Requirements for flashing yellow 180°/225° light for barges, canal boats, etc., that are being pushed ahead or towed along side of a tug boat. For use on 120 volts A.C. only. Federal Requirements for this light are applicable for: inland waters, the Atlantic, Pacific and Gulf coasts, intercoastal waterways and western rivers. Refer to the U.S. Inland Navigation Rules for application, configuration and technical details.

ORDERING INFORMATION

Galvanized Steel*	Plain Brass	Height Overall Inches	Height Lens Inches	Visibility Miles	Visibility Arc	Flashes Per Minute	Weight Pounds
1111 ME1 GAL	1111 ME1 PLB	11½	6¾	2	225°	50-70	6½

*Galvanized Steel Lights are Preprimed.

IMPORTANT BULB DATA

To comply with Federal Requirements this light must use a PERKO Cat. No. 342 004 CLR bulb.

SPARE PARTS ORDERING INFORMATION

Spare Flasher, Cat. No. 133. Spare Medium Prefocus Socket, Cat. No. 347 A00.
Spare O-Ring for Cap, Cat. No. 1119. Spare Access Cap, O-Ring and Retainer, Cat. No. 1105 000 BLK.
Spare Lens, Cat. No. 256 001 YLW.

PANAMA CANAL BLUE STEERING LIGHT FIG. 1129BA FOR USE ON VESSELS OF ANY LENGTH



Fig. 1129BA

Black Plastic, Pre-Wired Double Contact Socket with 3 Feet of 16/3-SJO Cable. For 12, 24, 32 or 120 Volts, Bulb Not Included.

ORDERING INFORMATION

Cat. No.	Visibility Arc	Height Overall Inches	Height Lens Inches	Weight Pounds
1129 BAO BLK	135°	7½	4½	3½

IMPORTANT BULB DATA

To comply with Panama Canal Requirements, the light above must use a PERKO Fig. No. 374 bulb.

SPARE PARTS ORDERING INFORMATION

Required Bulbs:

12 Volts, Cat. No. 374 001 CLR. Spare Lens, Cat. No. 249 000 BLU.
24 Volts, Cat. No. 374 002 CLR. Spare O-Ring for Cap, Cat. No. 1119.
32 Volts, Cat. No. 374 003 CLR. Spare Double Contact Socket, Cat. No. 134.
120 Volts, Cat. No. 374 004 CLR. Spare Plastic Cap, O-Ring and Retainer, Cat. No. 1105 000 BLK.



Fig. 454E



ALL-ROUND WHITE WHISTLE LIGHT FIG. 454E FOR USE ON VESSELS OVER 20 METERS (65.6 FT.) IN LENGTH

CAST BRONZE
Complete with Medium Prefocus Socket and 120 Volt Bulb.

ORDERING INFORMATION

Cat. No.	Height Overall In.	Height Lens In.	Tapped Pipe Size In.	Weight Pounds	Visibility Miles
454 EOO PLB	11½	6¾	1	8¼	5

SPARE PARTS ORDERING INFORMATION

Spare Bulb, Cat. No. 342 004 CLR. Spare Lens or Cover Gasket, Cat. No. 1143.
Spare Lens, Cat. No. 261 001 CLR. Spare Medium Prefocus Socket, Cat. No. 347.

EMERGENCY OIL NAVIGATION LIGHTS FOR USE ON VESSEL LENGTHS AS SPECIFIED BELOW

Sheet metal; Galvanized Steel, Plain or Polished Brass,
Bottom Opening, Complete with Mounting Bracket, Turret Top
and Oil Lamp in Base of Light.

Size No.	Height Overall Inches	Height Lens Inches	Weight Pounds
1	15	6¾	7
2	18	7½	10½

ORDERING INFORMATION

For Use On Vessels 20 Meters (65.6 ft.) To 50 Meters (164.0 ft.) In Length.

Description	Galvanized Steel	Plain Brass	Polished Brass	Visibility Arc
Red Side Light	21 RO1 GAL	21 RO1 PLB	21 RO1 POL	112½°
Green Side Light	21 GO1 GAL	21 GO1 PLB	21 GO1 POL	112½°
White Masthead Light	982 OO1 GAL	982 OO1 PLB	982 OO1 POL	225°
Red Masthead Light	982 RO1 GAL	982 RO1 PLB	982 RO1 POL	225°
Yellow Masthead Light	982 MO1 GAL	982 MO1 PLB	982 MO1 POL	225°
White Stern Light	985 OO1 GAL	985 OO1 PLB	985 OO1 POL	135°
Red Stern Light	985 RO1 GAL	985 RO1 PLB	985 RO1 POL	135°
Yellow Stern Light	985 MO1 GAL	985 MO1 PLB	985 MO1 POL	135°
White All-Round Light	23 OO1 GAL	23 OO1 PLB	23 OO1 POL	360°
Red All-Round Light	129 RO1 GAL	129 RO1 PLB	129 RO1 POL	360°
Green All-Round Light	129 GO1 GAL	129 GO1 PLB	129 GO1 POL	360°
Yellow All-Round Light	129 MO1 GAL	129 MO1 PLB	129 MO1 POL	360°



Fig. 21



Fig. 982

ORDERING INFORMATION

For Use On Vessels Over 20 Meters (65.6 ft.) In Length.

Description	Galvanized Steel	Plain Brass	Polished Brass	Visibility Arc
Red Side Light	21 RO2 GAL	21 RO2 PLB	21 RO2 POL	112½°
Green Side Light	21 GO2 GAL	21 GO2 PLB	21 GO2 POL	112½°
White Masthead Light	982 OO2 GAL	982 OO2 PLB	982 OO2 POL	225°
Red Masthead Light	982 RO2 GAL	982 RO2 PLB	982 RO2 POL	225°
Yellow Masthead Light	982 MO2 GAL	982 MO2 PLB	982 MO2 POL	225°
White Stern Light	985 OO2 GAL	985 OO2 PLB	985 OO2 POL	135°
Red Stern Light	985 RO2 GAL	985 RO2 PLB	985 RO2 POL	135°
Yellow Stern Light	985 MO2 GAL	985 MO2 PLB	985 MO2 POL	135°
White All-Round Light	23 OO2 GAL	23 OO2 PLB	23 OO2 POL	360°
Red All-Round Light	129 RO2 GAL	129 RO2 PLB	129 RO2 POL	360°
Green All-Round Light	129 GO2 GAL	129 GO2 PLB	129 GO2 POL	360°
Yellow All-Round Light	129 MO2 GAL	129 MO2 PLB	129 MO2 POL	360°



Fig. 985



Figs. 23 & 129

SPARE PARTS ORDERING INFORMATION

Spare Lenses:

112½° Cat. No. 259 No. 1 or 2, Specify Color
 135° Cat. No. 269 No. 1 or 2, Specify Color
 225° Cat. No. 256 No. 1 or 2, Specify Color
 360° Cat. No. 261 No. 1 or 2, Specify Color
 Spare Mounting Bracket, Cat. No. 143 000 ALU.

Spare Burner, Cat. No. 242 000 PLB.
 Spare Wick, Cat. No. 302 002.
 Spare Chimney, Cat. No. 267 000 CLR.
 Spare Oil Fount Size 1, Cat. No. 282 001 PLB.
 Spare Oil Fount Size 2, Cat. No. 282 002 PLB.

SPARE PARTS

FOR NAVIGATION LIGHTS ON VESSELS OVER 20 METERS (65.6 ft.) IN LENGTH

DUAL MEDIUM PREFOCUS SOCKET ASSEMBLY

Phenolic — 250 Volts — 1000 Watts



Plug In Type — Prewired — with two medium prefocus sockets. For use in double lens lights.

Cat. No.	Height Overall Inches	Width Overall Inches	Weight Ounces
303	3 ⁷ / ₈	3 ⁷ / ₈	9

Male Plug Only Cat. No 303 A00. Female Plug Only Cat. No. 303 B00.

112½° LENSES



	Height Overall Inches	Dia. Opening Inches	Cat. No.
Red	6 ³ / ₄	6 ¹ / ₈	259 001 RED
Green	6 ³ / ₄	6 ¹ / ₈	259 001 GRN
Red	7 ¹ / ₂	9 ¹ / ₄	259 002 RED
Green	7 ¹ / ₂	9 ¹ / ₄	259 002 GRN

Weight Size 1, 8.5 oz. Weight Size 2, 19.5 oz.

MEDIUM PREFOCUS SOCKETS

Phenolic — 250 Volts — 1000 Watts



Cat. No.	Height Overall Inches	Dia. Overall Inches	Standard Package	Weight Per Pkg. Ounces
347	1 ⁷ / ₈	1 ¹ / ₂	5	21 ¹ / ₂
347 A00	1 ⁷ / ₈	1 ¹ / ₂	5	21 ¹ / ₂

Cat. No. 347 A00 supplied with metal Mounting Cap Tapped for 3/8" I.P.S.

135° LENSES



	Height Overall Inches	Dia. Opening Inches	Cat. No.
White	6 ³ / ₄	5 ¹ / ₈	269 001 WH
Red	6 ³ / ₄	5 ¹ / ₈	269 001 RED
Yellow	6 ³ / ₄	5 ¹ / ₈	269 001 YLV
White	7 ¹ / ₂	7 ¹ / ₄	269 002 WH
Red	7 ¹ / ₂	7 ¹ / ₄	269 002 RED
Yellow	7 ¹ / ₂	7 ¹ / ₄	269 002 YLV

Weight Size 1, 14 oz. Weight Size 2, 18.5 oz.

DOUBLE CONTACT BAYONET BULBS

Clear — 12, 24, 32 or 120 Volts,
Type T-8, C-8, Filament — 1³/₈" L.C.L.



Cat. No.	Voltage	Wattage	Candella
374 001 CLR	12	30	24
374 002 CLR	24	30	24
374 003 CLR	32	30	24
374 004 CLR	120	30	24

Weight 1 oz.

Standard Pkg.-1pc.

225° LENSES



	Height Overall Inches	Dia. Opening Inches	Cat. No.
White	6 ³ / ₄	4 ¹ / ₂	256 001 WH
Red	6 ³ / ₄	4 ¹ / ₂	256 001 RED
Yellow	6 ³ / ₄	4 ¹ / ₂	256 001 YLV
White	7 ¹ / ₂	6 ⁵ / ₈	256 002 WH
Red	7 ¹ / ₂	6 ⁵ / ₈	256 002 RED
Yellow	7 ¹ / ₂	6 ⁵ / ₈	256 002 YLV

Weight Size 1, 18.5 oz. Weight Size 2, 27.5 oz.

MEDIUM PREFOCUS BULBS

Clear — 120 Volts

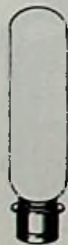

Cat. No.	Wattage
342 000 CLR	7.5
342 001 CLR**	15
342 002 CLR**	25
342 003 CLR**	40
342 004 CLR**	60
342 RS4 CLR*	60
342 006 CLR	125

Weight 1 oz.

*Designed for rough service.

Standard Pkg.-1pc. **OEM Pkg.-25 pcs.

360° LENSES



	Height Overall Inches	Dia. Opening Inches	Clear Cat. No.	Frosted Cat. No.
White	6 ³ / ₄	5 ¹ / ₈	261 001 CLR	261 001 FRD
Red	6 ³ / ₄	5 ¹ / ₈	261 001 RED	261 RF1 RED
Green	6 ³ / ₄	5 ¹ / ₈	261 001 GRN	261 GF1 GRN
Yellow	6 ³ / ₄	5 ¹ / ₈	261 001 YLV	261 MF1 YLV
Gray	6 ³ / ₄	5 ¹ / ₈	261 001 GRY	—
White	7 ¹ / ₂	7 ³ / ₈	261 002 CLR	261 002 FRD
Red	7 ¹ / ₂	7 ³ / ₈	261 002 RED	261 RF2 RED
Green	7 ¹ / ₂	7 ³ / ₈	261 002 GRN	261 GF2 GRN
Yellow	7 ¹ / ₂	7 ³ / ₈	261 002 YLV	261 MF2 YLV

Weight Size 1, 13.5 oz. Weight Size 2, 43 oz.

SINGLE CONTACT PREFOCUS BULBS

C-8 Filament Clear — 12 Volts



Cat. No.	Amperage	Mfg. No.
373 001 CLR	.25	25A/S8
373 002 CLR	.55	55A/S8
373 003 CLR	.77	77A/S8
373 004 CLR	1.15	1.15A/S8
373 005 CLR	2.03	2.03A/S8SCP

Weight 1 oz.

Standard Pkg.-1pc.

360° LENSES

With Top Assembly



	Height Overall Inches	Dia. Overall Inches	Cat. No.
White	5 ³ / ₄	5 ¹ / ₂	249 000 CLR
Red	5 ³ / ₄	5 ¹ / ₂	249 000 RED
Green	5 ³ / ₄	5 ¹ / ₂	249 000 GRN
Yellow	5 ³ / ₄	5 ¹ / ₂	249 000 YLV
Gray	5 ³ / ₄	5 ¹ / ₂	249 000 GRY

Weight 17 oz.

DECK CONTROL SEARCHLIGHTS

FIGS. 534 & 538

Fig. 534 — Chrome Plated Brass Head with Chrome Plated Bronze Base

Fig. 538 — Chrome Plated Brass Head with Chrome Plated Brass Base

For 12, 24 or 32 Volts,
4 1/2 or 7 Inch Sealed Beam Bulb,
Tungsten or Halogen, Switch in Head

ORDERING INFORMATION

Voltage	O.D. Bulb	Approx. Range	Beam	Wattage	Height Overall	Base Dimensions	Catalog Number	Weight Pounds
	Inches	Miles	Candlepower		Inches	Inches		
12	4 1/2	1/4	50,000	30	7 1/2	3 1/2 O.D.	538 000 CHR	1 1/2
12	4 1/2	1/3	100,000	50	7 1/2	3 1/2 O.D.	538 H00 CHR*	1 1/2
12	7	5/8	250,000	100	12 1/2	4 7/8 x 3 1/8	534 003 12V	5
24	7	3/4	470,000	450	12 1/2	4 7/8 x 3 1/8	534 003 24V	5
32	7	5/8	260,000	200	12 1/2	4 7/8 x 3 1/8	534 003 32V	5

Fig. 534



Fig. 538



* NOTE: "H" in the Catalog Number Designates a Halogen Bulb.

REMOVABLE DECK CONTROL SEARCHLIGHT

FIG. 440

Chrome Plated Brass Head with Chrome Plated Zinc Base

For 12 or 32 Volts, 4 1/2 or 7 Inch Sealed Beam Bulb
Complete with 8 Feet of Coiled Cord, Cigarette Lighter Plug
and Watertight Deck Connection. Switch in Head

ORDERING INFORMATION

Voltage	O.D. Bulb	Approx. Range	Beam	Wattage	Height Overall	Catalog Number	Weight Pounds
	Inches	Miles	Candlepower		Inches		
12	4 1/2	1/4	50,000	30	7 1/2	440 001 12V	2 1/4
12	4 1/2	1/3	100,000	50	7 1/2	440 H01 12V*	2 1/4
12	7	5/8	250,000	100	10	440 003 12V	3 1/2
32	7	5/8	260,000	200	10	440 003 32V	3 1/2



Fig. 440

Base Diameter, 2 1/8 Inches.

* NOTE: "H" in the Catalog Number Designates a Halogen Bulb.

PILOT HOUSE CONTROL SEARCHLIGHT

FIG. 535

Chrome Plated Brass Head with
Chrome Plated Bronze Base

For 12, 24 or 32 Volts,
7 Inch Sealed Beam Bulb

Lever Handle Controls Both Horizontal and Vertical Movement.

Control Length, 7 1/2 Inches.

Maximum Ceiling Thickness, 4 1/2 Inches.

ORDERING INFORMATION

Voltage	Approx. Range	Beam	Wattage	Catalog Number
	Miles	Candlepower		
12	5/8	250,000	100	535 003 12V
24	3/4	470,000	450	535 003 24V
32	5/8	260,000	200	535 003 32V

Base Dimensions, 4 7/8 x 3 1/8 Inches.

Weight, 5 Pounds.



Fig. 535

SPARE SEALED BEAM ORDERING INFORMATION

Spare 4 1/2 Inch Sealed Beam Unit, Cat. No. 433 001 12V.
Spare 4 1/2 Inch Halogen Sealed Beam Unit, Cat. No. 435 001 12V.

Spare 7 Inch Sealed Beam Unit (12 volt), Cat. No. 433 003 12V.
Spare 7 Inch Sealed Beam Unit (24 volt), Cat. No. 433 003 24V.
Spare 7 Inch Sealed Beam Unit (32 volt), Cat. No. 433 003 32V.

SEALED BEAM SEARCHLIGHTS

Bronze Base, Brass Body

Polished Chrome Plated or White PERKO-KOTE Powder Coating

For 12, 24 or 32 Volts.

Dimensions (Inches)

"A"	"B"	"C"	"D"	"G"	"H"
8	8 1/2	10	7	2	2 1/8

Electrical Specifications

Voltage	Wattage	Candlepower	Approx. Range Miles	Sealed Beam Cat. No.
12	100	250,000	5/8	433 003 12V
24	450	470,000	3/4	433 003 24V
32	200	260,000	5/8	433 003 32V

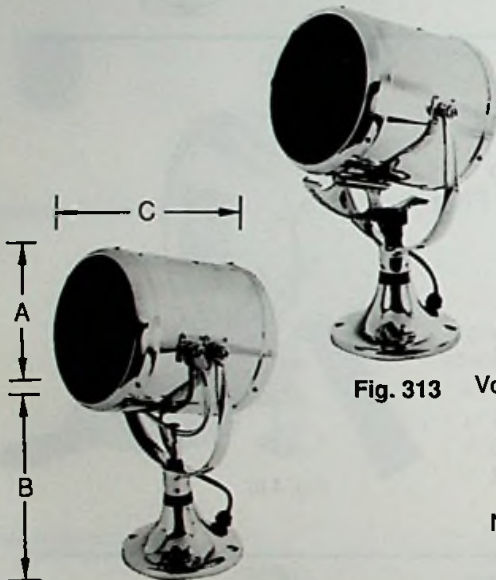

Fig. 313

Fig. 305

Searchlight Heads — Figs. 305 & 313

ORDERING INFORMATION

For Lever Control Polished Chrome Voltage Cat. No.	For Lever Control White PERKO-KOTE Cat. No.	For Wheel or Lever/Gear Control Polished Chrome Cat. No.	For Wheel or Lever/Gear Control White PERKO-KOTE Cat. No.
12 305 H12 CHR	305 H12 WHT	313 H12 CHR	313 H12 WHT
24 305 H24 CHR	305 H24 WHT	313 H24 CHR	313 H24 WHT
32 305 H32 CHR	305 H32 WHT	313 H32 CHR	313 H32 WHT

Nominal Weight - 20 lbs.

Control Assemblies — Figs. 851, 852 & 969

Stainless Steel Tubes With Chrome Plated Fittings.

Control Assemblies of Different Lengths May Be Interchanged to Offer a Large Variety of Searchlights With a Minimum of Inventory.

ORDERING INFORMATION

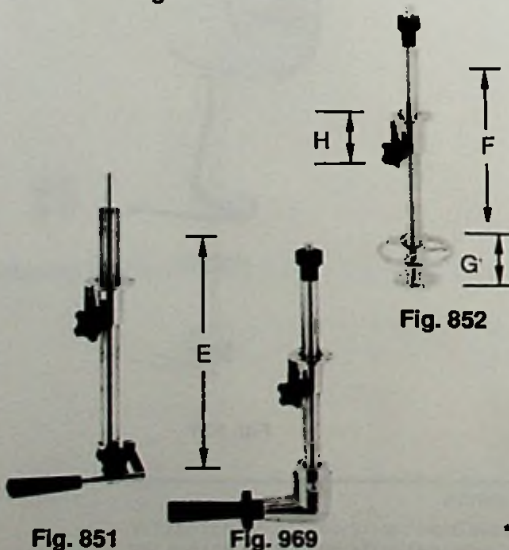

Fig. 851

Fig. 969

Fig. 852

Control Length Inches	"E" Lever Control* Cat. No.	"E" Lever/Gear Control Cat. No.	"F" Wheel Control Cat. No.	Nominal Weight Pounds
8 1/2	851 000*	969 000**	852 000***	6
15 1/2	851 0A0	969 0A0	852 0A0	9
22 1/2	851 0B0	969 0B0	852 0B0	12
29 1/2	851 0C0	969 0C0	852 0C0	15

* Maximum Ceiling Thickness, 4 1/2 Inches.

** Maximum Ceiling Thickness, 3 1/2 Inches.

*** Maximum Ceiling Thickness, 3 Inches.

SOLAR-RAY® SEARCHLIGHTS — 800 SERIES 10", 12" or 14"

**CAST BRONZE AND HEAVY GAUGE BRASS
POLISHED CHROME OR WHITE PERKO-KOTE FINISH
12, 24, 32, 120 or 230 VOLTS**

The 800 Series — Solar-Ray® Searchlights are available in 10", 12", and 14" sizes with your choice of Deck, Wheel, Lever or Lever/Gear Controls. All models feature: halo deflectors, parabolic glass mirror reflectors for maximum light output and ventilation covers for quick dissipation of heat to help prolong bulb life. Hinged front doors have quick release stainless steel latches to provide easy access for bulb replacement. The 800 Series models are also available in our white PERKO-KOTE finish; an advanced powder coating process that eliminates the need for painting while providing a scratch resistant and chip-proof surface for painting when necessary to match the color of the vessel.

Bulbs are not included and must be ordered separately. PERKO offers a choice of the traditional incandescent or the brighter, more piercing quartz-halogen bulbs in a broad variety of voltages and wattages to fit every need. For complete information on bulbs and candlepower output, see page 59.

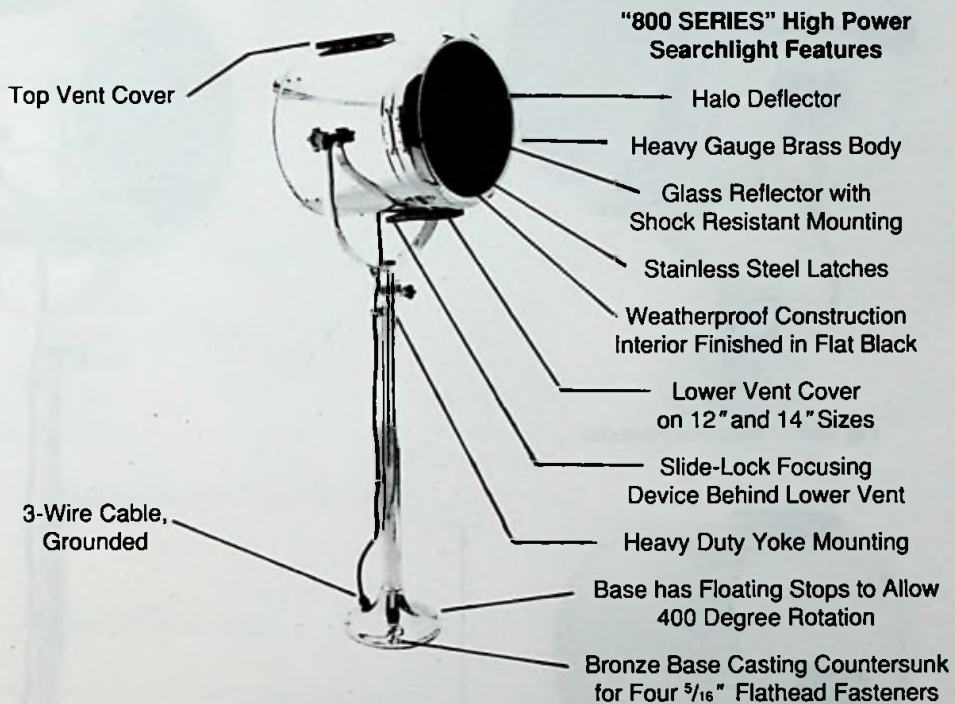

CONTROL TYPES

DECK CONTROL

Equipped with handles on the rear cover for positioning.

LEVER CONTROL

Aim Handle for horizontal position. Move handle up & down for vertical position.

WHEEL CONTROL

Turn upper wheel for horizontal position. Turn lower wheel for vertical position.

LEVER/GEAR CONTROL

Aim handle for horizontal position. Twist handle for vertical position.



DECK CONTROL SOLAR-RAY® SEARCHLIGHT FIG. 883 10", 12" and 14"

Searchlight Dimensions

"A" Nominal Drum Diameter Inches	"C" Length Drum Inches	Nominal Weight Pounds
10	13	28
12	15	38
14	17	45

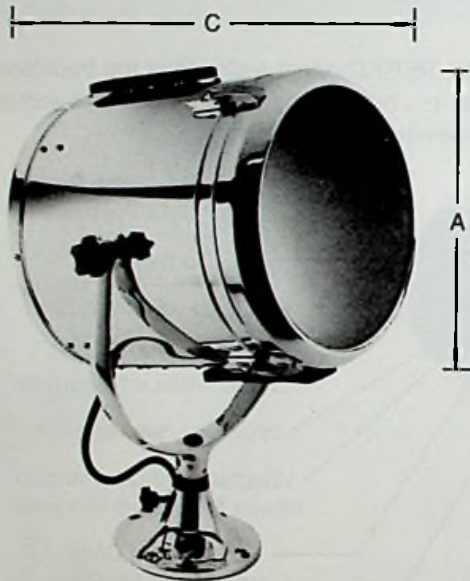

Fig. 883 — Standard Pedestal

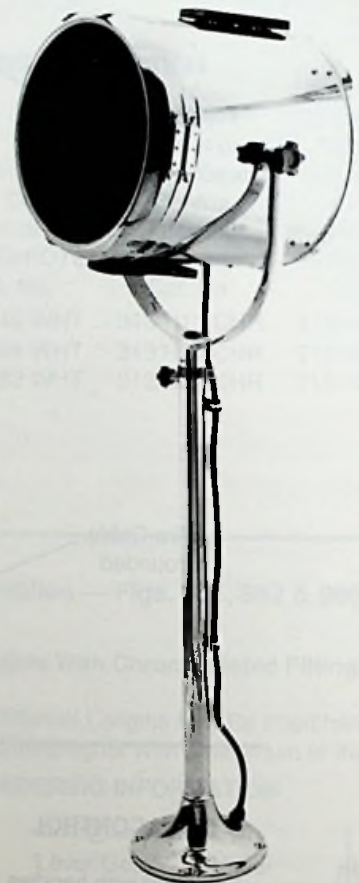

Fig. 883 — High Pedestal

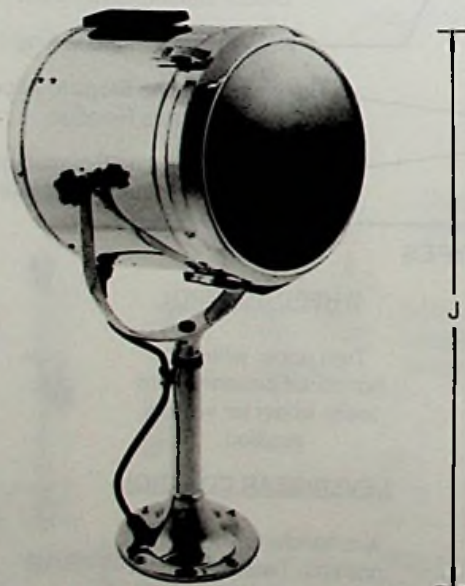

Fig. 883 — Medium Pedestal

**DECK CONTROL SOLAR-RAY® SEARCHLIGHT FIG. 883
10", 12" and 14"****ORDERING INFORMATION**

- NOTES: 1) These Searchlights Can Not Be Fitted With Controls.
 2) Bulbs Must be Ordered Separately, Refer to Pages 58 and 59 for Ordering Information.
 3) Refer to Worksheet on Page 60 For Help in Ordering.

Standard Pedestal Searchlights

Reflector Size Inches	"J" Height Overall Inches	Polished Chrome Catalog No.	White PERKO-KOTE Catalog No.
10	20 1/8	883 0P1 CHR	883 0P1 WHT
12	22 1/8	883 0P2 CHR	883 0P2 WHT
14	25 1/8	883 0P3 CHR	883 0P3 WHT

Standard Pedestal Base Diameter, 7 Inches.

Medium Pedestal Searchlights

Reflector Size Inches	"J" Height Overall Inches	Polished Chrome Catalog No.	White PERKO-KOTE Catalog No.
10	27 1/2	883 MP1 CHR	883 MP1 WHT
12	29 1/2	883 MP2 CHR	883 MP2 WHT
14	31 1/2	883 MP3 CHR	883 MP3 WHT

Medium Pedestal Base Diameter, 8 Inches.

High Pedestal Searchlights

Reflector Size Inches	"J" Height Overall Inches	Polished Chrome Catalog No.	White PERKO-KOTE Catalog No.
10	44	883 HP1 CHR	883 HP1 WHT
12	46	883 HP2 CHR	883 HP2 WHT
14	48	883 HP3 CHR	883 HP3 WHT

High Pedestal Base Diameter, 8 Inches.

**NOTE: Custom Pedestal Heights are Available.
 Price Upon Application.
 Specify the "J" Dimension for Custom Pedestal Height.**

LEVER CONTROL SOLAR-RAY® SEARCHLIGHTS 10", 12" and 14"

Searchlight Dimensions

"A" Nominal Drum Diameter Inches	"C" Length Drum Inches	Nominal Weight Pounds
10	13	28
12	15	38
14	17	45

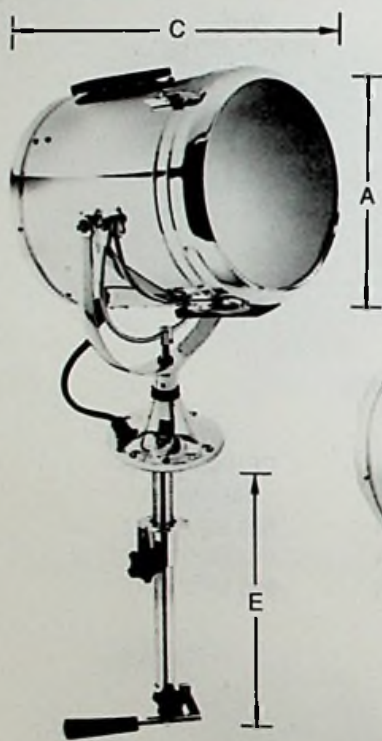

Standard Pedestal



Medium Pedestal

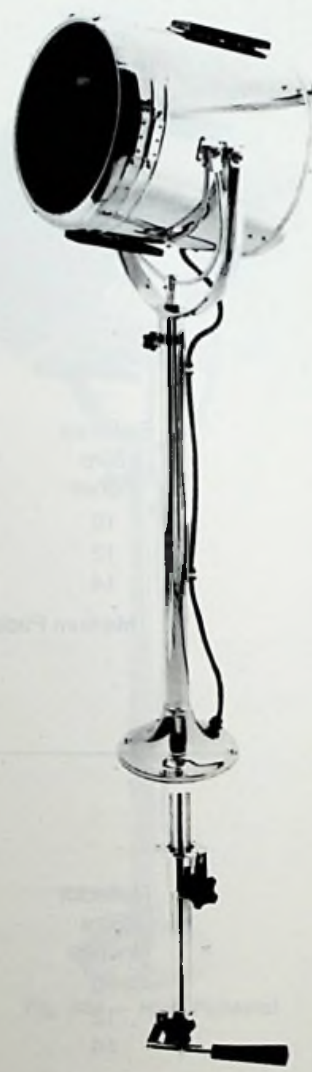

High Pedestal

LEVER CONTROL SOLAR-RAY® SEARCHLIGHT HEAD ASSEMBLIES FIG. 884 10", 12" and 14"

ORDERING INFORMATION

- NOTES: 1) Bulbs Must be Ordered Separately, Refer to Pages 58 and 59 for Ordering Information.
2) Refer to Worksheet on Page 60 For Help in Ordering.

Standard Pedestal Searchlight Head Assemblies

Reflector Size Inches	"J" Height Overall Inches	Polished Chrome Catalog No.	White PERKO-KOTE Catalog No.
10	20 1/8	884 0P1 CHR	884 0P1 WHT
12	22 1/8	884 0P2 CHR	884 0P2 WHT
14	25 1/8	884 0P3 CHR	884 0P3 WHT

Standard Pedestal Base Diameter, 7 Inches.

Medium Pedestal Searchlight Head Assemblies

Reflector Size Inches	"J" Height Overall Inches	Polished Chrome Catalog No.	White PERKO-KOTE Catalog No.
10	28 1/4	884 MP1 CHR	884 MP1 WHT
12	30 1/4	884 MP2 CHR	884 MP2 WHT
14	33 1/4	884 MP3 CHR	884 MP3 WHT

Medium Pedestal Base Diameter, 8 Inches.

High Pedestal Searchlight Head Assemblies

Reflector Size Inches	"J" Height Overall Inches	Polished Chrome Catalog No.	White PERKO-KOTE Catalog No.
10	44 3/4	884 HP1 CHR	884 HP1 WHT
12	46 3/4	884 HP2 CHR	884 HP2 WHT
14	49 3/4	884 HP3 CHR	884 HP3 WHT

High Pedestal Base Diameter, 8 Inches.

NOTE: Custom Pedestal Heights are Available. Price Upon Application.
Specify the "J" Dimension for Custom Pedestal Height.

LEVER CONTROL ASSEMBLIES FIG. 851

Control assemblies of different lengths may be interchanged on Solar-Ray® searchlights (Fig. 884) of the same pedestal height. The following chart makes it possible to order and stock different styles of these assemblies separately to offer a large variety of Solar-Ray® searchlights with a minimum of inventory.

ORDERING INFORMATION

"E" Length Control Inches	For Standard Pedestal Cat. No.	For Medium Pedestal Cat. No.	For High Pedestal Cat. No.	Nominal Weight Pounds
8 1/2	851 000*	851 M00*	851 H00*	6
15 1/2	851 0A0	851 MA0	851 HA0	9
22 1/2	851 0B0	851 MB0	851 HB0	12
29 1/2	851 0C0	851 MC0	851 HC0	15

*Maximum Ceiling Thickness, 4 1/2 Inches.

NOTE: Custom Control Lengths are Available. Price Upon Application.
Specify "E" Dimension for Custom Control Lengths.

WHEEL OR LEVER/GEAR CONTROL SOLAR-RAY® SEARCHLIGHTS 10", 12" and 14"

Searchlight Dimensions

"A" Nominal Drum Diameter Inches	"C" Length Drum Inches	Nominal Weight Pounds
10	13	28
12	15	38
14	17	45

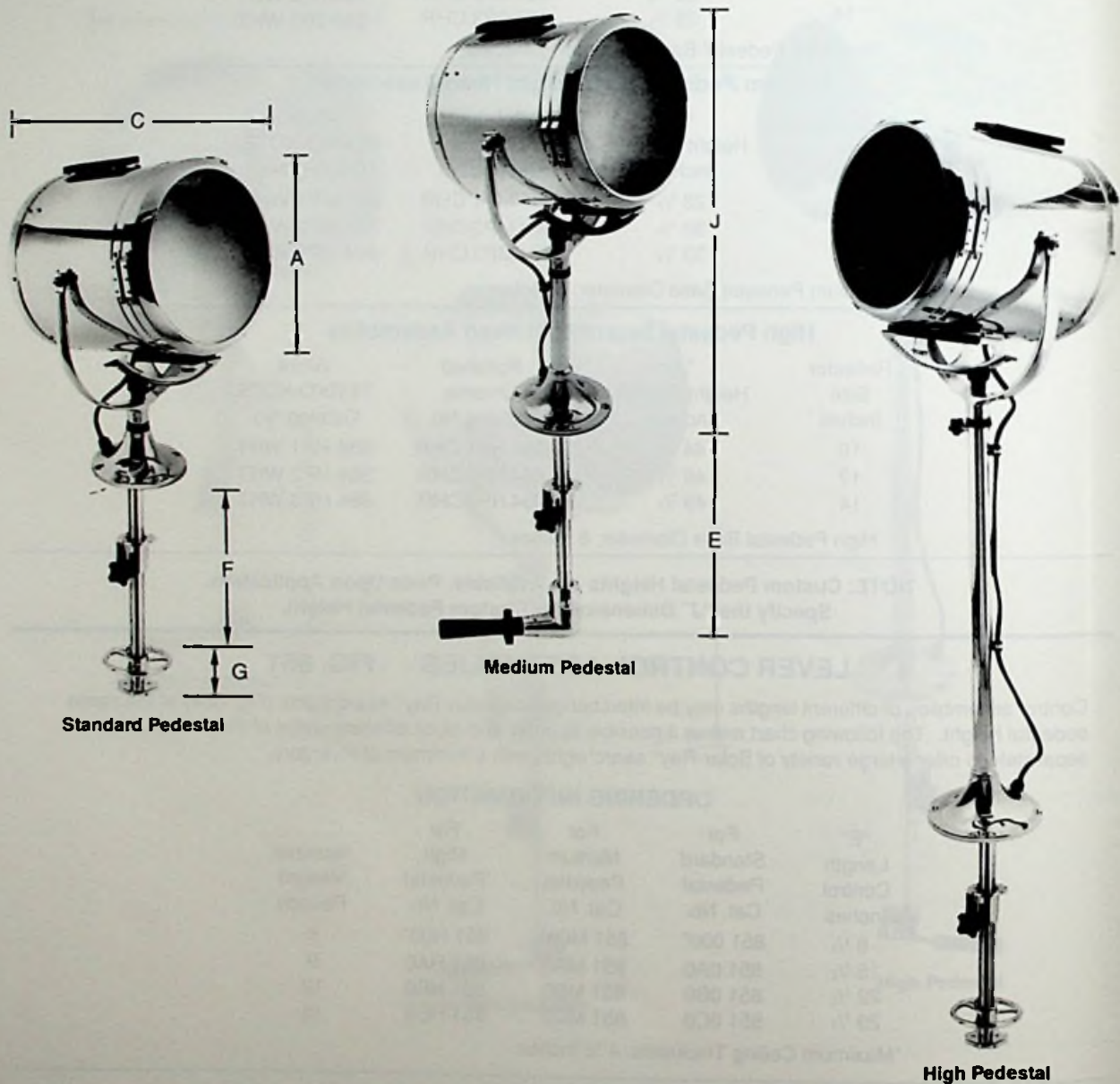

WHEEL OR LEVER/GEAR CONTROL SOLAR-RAY® SEARCHLIGHT HEAD ASSEMBLIES FIG. 885

10", 12" and 14"

ORDERING INFORMATION

- NOTES: 1) Bulbs Must be Ordered Separately, Refer to Pages 58 and 59 for Ordering Information.
 2) Refer to Worksheet on Page 60 For Help in Ordering.

Standard Pedestal Searchlight Head Assemblies

Reflector Size Inches	"J" Height Overall Inches	Polished Chrome Catalog No.	White PERKO-KOTE Catalog No.
10	20 1/8	885 0P1 CHR	885 0P1 WHT
12	22 1/8	885 0P2 CHR	885 0P2 WHT
14	25 1/8	885 0P3 CHR	885 0P3 WHT

Standard Pedestal Base Diameter, 7 Inches.

Medium Pedestal Searchlight Head Assemblies

Reflector Size Inches	"J" Height Overall Inches	Polished Chrome Catalog No.	White PERKO-KOTE Catalog No.
10	28 1/4	885 MP1 CHR	885 M01 WHT
12	30 1/4	885 MP2 CHR	885 MP2 WHT
14	33 1/4	885 MP3 CHR	885 MP3 WHT

Medium Pedestal Base Diameter, 8 Inches.

High Pedestal Searchlight Head Assemblies

Reflector Size Inches	"J" Height Overall Inches	Polished Chrome Catalog No.	White PERKO-KOTE Catalog No.
10	44 3/4	885 HP1 CHR	885 HP1 WHT
12	46 3/4	885 HP2 CHR	885 HP2 WHT
14	49 3/4	885 HP3 CHR	885 HP3 WHT

High Pedestal Base Diameter, 8 Inches.

NOTE: Custom Pedestal Heights are Available. Price Upon Application. Specify the "J" Dimension for Custom Pedestal Height.

CONTROL ASSEMBLIES FIGS. 852 & 969

Control Assemblies of different lengths may be interchanged on Solar-Ray® searchlights (Fig. 885) of the same pedestal height. The following chart makes it possible to order and stock different styles of these assemblies separately to offer a large variety of Solar-Ray® Searchlights with a minimum of inventory.

Wheel Control — Fig. 852

ORDERING INFORMATION

"F" Length Control Inches	For Standard Pedestal Cat. No.	For Medium Pedestal Cat. No.	For High Pedestal Cat. No.	Nominal Weight Pounds
7 1/2	852 000*	852 M00*	852 H00*	6
14 1/2	852 0A0	852 MA0	852 HA0	9
21 1/2	852 0B0	852 MB0	852 HB0	12
28 1/2	852 0C0	852 MC0	852 HC0	15

"G" Distance Between Wheels, 2 Inches.

*Maximum Ceiling Thickness, 3 Inches.

Lever/Gear Control — Fig. 969

ORDERING INFORMATION

"E" Length Control Inches	For Standard Pedestal Cat. No.	For Medium Pedestal Cat. No.	For High Pedestal Cat. No.	Nominal Weight Pounds
8 1/2	969 000*	969 M00*	969 H00*	6
15 1/2	969 0A0	969 MA0	969 HA0	9
22 1/2	969 0B0	969 MB0	969 HB0	12
29 1/2	969 0C0	969 MC0	969 HC0	15

*Maximum Ceiling Thickness, 3 1/2 Inches.

NOTE: Custom Control Lengths are Available. Price Upon Application. Specify "E" or "F" Dimension for Custom Control Lengths.

BULB AND SOCKET ORDERING INFORMATION FOR SOLAR-RAY® SEARCHLIGHTS 800 SERIES — 10", 12" and 14"

BULBS ARE NOT INCLUDED IN LIGHTS

To give good results, the bulb and reflector must be perfectly compatible; therefore be sure to specify the catalog number of the bulb desired. Peak candlepower is exceedingly sensitive to many factors, (i.e., a light source out of focus by 1/32 inch. Under-voltage of only 4%, or differences between bulb manufacturers can cause a reduction of range of up to 20%.

INCANDESCENT BULB ORDERING INFORMATION

Bulb Catalog Number	Voltage	Wattage	Socket Type	Socket Code Letter	For Searchlight Sizes Inches	Rated* Life Hours	Mfg. Bulb Code
806	32	500	Medium Screw	B	10, 12, 14	50	DLT
807	120	500	Medium Prefocus	E	10, 12, 14	25	CZX
809	120	750	Medium Prefocus	E	12, 14	25	DPJ
837	120	750	Medium Prefocus	E	12, 14	200	DDY
810	120	1000	Medium Prefocus	E	12, 14	25	DRS
811	120	1000	Mogul Screw	D	12, 14	25	DRW
860	230	1000	Medium Prefocus	E	12, 14	50	DWK

For a More Concentrated Beam, Longer Range, Brighter Light and a Longer Life, We Recommend the Following Bulbs.

"QUARTZ" TUNGSTEN-HALOGEN BULB ORDERING INFORMATION

Bulb Catalog Number	Voltage	Wattage	Socket Type	Socket Code Letter	For Searchlight Sizes Inches	Rated* Life Hours	Mfg. Bulb Code
816	12	100	2-Pin Prefocus	F	10, 12, 14	50	FDT
836	24	150	2-Pin Prefocus	G	10, 12, 14	50	DZE-FDS
817	32	200	2-Pin Prefocus	H	10, 12, 14	200	G.E. 1945
844	120	500	Medium Prefocus	E	10, 12, 14	100	BTM
820	120	600	2-Pin Prefocus	I	10, 12, 14	75	DYS
845	120	750	Medium Prefocus	E	12, 14	200	BTP
839	120	900	2-Pin Prefocus	K	12, 14	75	BVA
846	120	1000	Medium Prefocus	E	12, 14	200	BTR

Please Order Carefully, Bulbs are Not Returnable.

* NOTE: These are the "Rated Average Laboratory Life in Hours" of the Bulb Manufacturer obtained in closely controlled laboratory life testing of groups of lamps at their design voltage. It is not necessarily the same as the service life where conditions such as shock, vibration, voltage fluctuation and environment may result in a shorter average attained life.

ELECTRIC SOCKET AND SUPPORT STAND ASSEMBLIES

Solar-Ray® Searchlights include a socket and support stand assembly based on the bulb or socket information given when ordering. The following chart makes it possible to order and stock different socket and stand assemblies for field conversion, to meet a large variety of voltage and candlepower requirements with a minimum of inventory.

ORDERING INFORMATION

Socket Type	Socket Code	For 10" Searchlights		For 12" Searchlights		For 14" Searchlights	
		Catalog Number	Height Stand Inches	Catalog Number	Height Stand Inches	Catalog Number	Height Stand Inches
Medium Screw	B	872 001	1 1/4	872 002	2 1/4	872 003	3 1/4
Medium Prefocus	E	873 001	1 5/16	873 002	1 15/16	873 003	2 15/16
Mogul Screw	D	-----	-----	874 002	7/16	874 003	1 1/4
2-Pin Prefocus (12 Volt)	F	875 001	3 1/2	875 002	4 1/2	875 003	5 1/2
2-Pin Prefocus (24 Volt)	G	876 001	3 1/4	876 002	4 1/4	876 003	5 1/4
2-Pin Prefocus (32 Volt)	H	878 001	3 3/4	878 002	4 3/4	878 003	5 3/4
2-Pin Prefocus (600 Watt)	I	879 001	3 1/8	879 002	4 1/8	879 003	5 1/8
2-Pin Prefocus (900 Watt)	K	-----	-----	880 002	3 13/16	880 003	4 13/16

NOTE: Refer to Page 64 for Spare/Replacement Electric Socket Only Ordering Information.

BULB TECHNICAL DATA FOR 800 SERIES SOLAR-RAY® SEARCHLIGHTS

The Following Chart is Provided to Aid in Proper Bulb Selection.

Searchlight Size Inches	Voltage	Approximate Range Miles*	Bulb Catalog Number	Bulb Wattage	Rated Life Hours**	Maximum Candlepower Output	Horizontal Beam Spread Degrees	Vertical Beam Spread Degrees
10"	12	1	816	100	50	1,168,000	1.7	1.4
	24	1	836	150	50	891,000	2.6	1.5
	32	3/4	817	200	200	571,000	2.6	1.7
	32	1	806	500	50	943,000	3.4	3.9
	120	1	820	600	75	908,000	4.4	2.2
	120	1 1/8	807	500	25	1,332,000	3.5	2.8
	120	1 1/8	844	500	100	1,375,000	3.1	3.4
12"	12	1 1/4	816	100	50	1,617,000	1.5	1.2
	24	1 1/8	836	150	50	1,349,000	2.2	1.5
	32	7/8	817	200	200	865,000	2.4	1.6
	32	1 1/8	806	500	50	1,496,000	3.4	3.5
	120	1	837	750	200	977,000	4.1	3.7
	120	1	845	750	200	1,185,000	3.7	5.2
	120	1 1/8	820	600	75	1,410,000	4.3	1.9
	120	1 1/4	809	750	25	1,747,000	3.6	3.4
	120	1 1/4	844	500	100	1,790,000	3.2	3.4
	120	1 1/4	807	500	25	1,799,000	3.3	3.1
	120	1 1/4	811	1000	25	1,816,000	4.0	4.9
	120	1 3/8	810	1000	25	1,894,000	4.0	3.8
	120	1 3/8	846	1000	200	1,911,000	3.9	5.0
	120	1 1/2	839	900	75	2,482,000	4.5	5.5
230	7/8	860	1000	25	865,000	6.9	5.9	
14"	12	1 1/4	816	100	50	1,756,000	1.5	1.0
	24	1 1/8	836	150	50	1,367,000	2.3	1.2
	32	1	817	200	200	943,000	2.2	1.5
	32	1 1/8	806	500	50	1,591,000	4.0	3.7
	120	1 1/8	837	750	200	1,254,000	3.9	4.5
	120	1 1/8	845	750	200	1,531,000	3.6	5.1
	120	1 1/4	820	600	75	1,626,000	4.5	1.9
	120	1 3/8	844	500	100	2,007,000	2.9	3.2
	120	1 3/8	811	1000	25	2,249,000	4.0	5.1
	120	1 1/2	807	500	25	2,353,000	3.2	3.2
	120	1 1/2	809	750	25	2,361,000	3.7	4.0
	120	1 1/2	846	1000	200	2,586,000	3.8	5.0
	120	1 1/2	810	1000	25	2,621,000	4.0	4.5
	120	1 5/8	839	900	75	2,889,000	4.5	5.2
230	1	860	1000	50	1,021,000	7.7	6.2	

* The approximate ranges listed above are based on photometric measurements of beam candlepower output under ideal conditions. Many factors such as atmospheric conditions, size and color of target, background, etc., may reduce effective range considerably; therefore, these figures are offered only as a guide to compare different bulb and voltage options.

** NOTE: These are the "Rated Average Laboratory Life in Hours" of the Bulb Manufacturer obtained in closely controlled laboratory life testing of groups of lamps at their design voltage. It is not necessarily the same as the service life where conditions such as shock, vibration, voltage fluctuation and environment may result in a shorter average attained life.



2-Pin Prefocus



Mogul Screw



Medium Prefocus



Medium Screw

PERKO® 800 SERIES SOLAR-RAY® SEARCHLIGHT ORDERING WORKSHEET

1) Head Assembly Type: _____
 a) For deck control - 883
 b) For lever control - 884
 c) For wheel and lever/gear control - 885

2) Pedestal (overall) Height (see catalog page for details): _____
 a) Standard - 0
 b) Medium - M
 c) High - H
For custom pedestal height see no. 10 below.

3) Reflector Size: _____
 a) 10 inch - 1
 b) 12 inch - 2
 c) 14 inch - 3

4) Finish: _____
 a) PERKOPATE (polished chrome) - CHR
 b) PERKO-KOTE (white) - WHT

5) Control Type: _____
 a) Lever control (For 884 Head Assembly) - 851
 b) Wheel control (For 885 Head Assembly) - 852
 c) Lever/Gear control (For 885 Head Assembly) - 969

6) Control Length (when necessary): _____
 a) (8 1/2" for 851 & 969) or (7 1/2" for 852) - 0
 b) (15 1/2" for 851 & 969) or (14 1/2" for 852) - A
 c) (22 1/2" for 851 & 969) or (21 1/2" for 852) - B
 d) (29 1/2" for 851 & 969) or (28 1/2" for 852) - C
For custom control length see no. 9 below.

7) Bulb Number (see pages 58 & 59 for details): _____ → Cat. No. _____

8) Socket Type: _____ Code: _____
 a) Medium Screw "B"
 b) Medium Prefocus "E"
 c) Mogul Screw "D" (Not for use with 10 inch reflector.)
 d) 2-Pin Prefocus (12 volt) "F"
 e) 2-Pin Prefocus (24 volt) "G"
 f) 2-Pin Prefocus (32 volt) "H"
 g) 2-Pin Prefocus (600 watt) "I"
 h) 2-Pin Prefocus (900 watt) "K" (Not for use with 10 inch reflector.)

9) Custom control length: _____
 Specify control length desired as measured from pedestal base to lower end of control assembly ("E" or "F" dimension).

10) Custom pedestal height: _____
 Specify overall height of searchlight desired as measured from the top of the searchlight head to the bottom of the pedestal base ("J" dimension).

Head Assembly
Cat. No. _____

Control Assembly
Cat. No. _____

Bulb
Cat. No. _____

Socket
Code _____

_____ | **P** | _____

_____ | | **0** | _____

SPARE PARTS FOR 800 SERIES SOLAR-RAY® SEARCHLIGHTS

Fig.	Size	Front Glass Cat. No.	Front Door with Glass Cat. No.	Rear Cover Cat. No.	Reflector * Cat. No.	Pinion Gear Cat. No.
883	10"	889 001 CLR	891 001 CHR	908 001 CHR	890 001	---
	12"	889 002 CLR	891 002 CHR	908 002 CHR	890 002	---
	14"	889 003 CLR	891 003 CHR	908 003 CHR	890 003	---
884	10"	889 001 CLR	891 001 CHR	902 001 CHR	890 001	---
	12"	889 002 CLR	891 002 CHR	902 002 CHR	890 002	---
	14"	889 003 CLR	891 003 CHR	902 003 CHR	890 003	---
885 and 886	10"	889 001 CLR	891 001 CHR	902 001 CHR	890 001	905
	12"	889 002 CLR	891 002 CHR	902 002 CHR	890 002	905
	14"	889 003 CLR	891 003 CHR	902 003 CHR	890 003	905

NOTE: The Spare Part catalog numbers listed above are for the polished chrome (CHR) finish. To order white finish, replace the "CHR" in the catalog number with the "WHT" finish code.

* Replacement Retaining Clips (Cat. No. 910) For The Reflector Should Also Be Ordered When Ordering a Replacement Reflector To Assure a Proper Fit.

19" SOLAR-RAY® SEARCHLIGHTS — 1900 SERIES

ALL ALUMINUM — WHITE PERKO-KOTE FINISH
32, 120 or 230 VOLTS

The 1900 Series - Solar-Ray® Searchlights are designed and built with the commercial user in mind where maximum size and brilliance counts. These units are constructed of marine aluminum with heavy duty castings and heavy gauge reinforced bodies for extra durability. They are finished in our white PERKO-KOTE finish; an advanced powder coating process that eliminates the need for painting while providing a scratch resistant and chip-proof surface for painting when necessary to match the color of the vessel.

The 1900 Series is available with Deck, Wheel or Lever/Gear Controls. All models feature halo deflectors, parabolic glass mirror reflectors for maximum light output and ventilation covers for quick dissipation of heat to help prolong bulb life. Hinged front doors have quick release stainless steel latches to provide easy access for bulb replacement.

Bulbs are not included and must be ordered separately. PERKO offers a choice of the traditional incandescent or the brighter, more piercing quartz-halogen bulbs in a variety of voltages and wattages. For complete information on bulbs and candlepower output, see page 63.

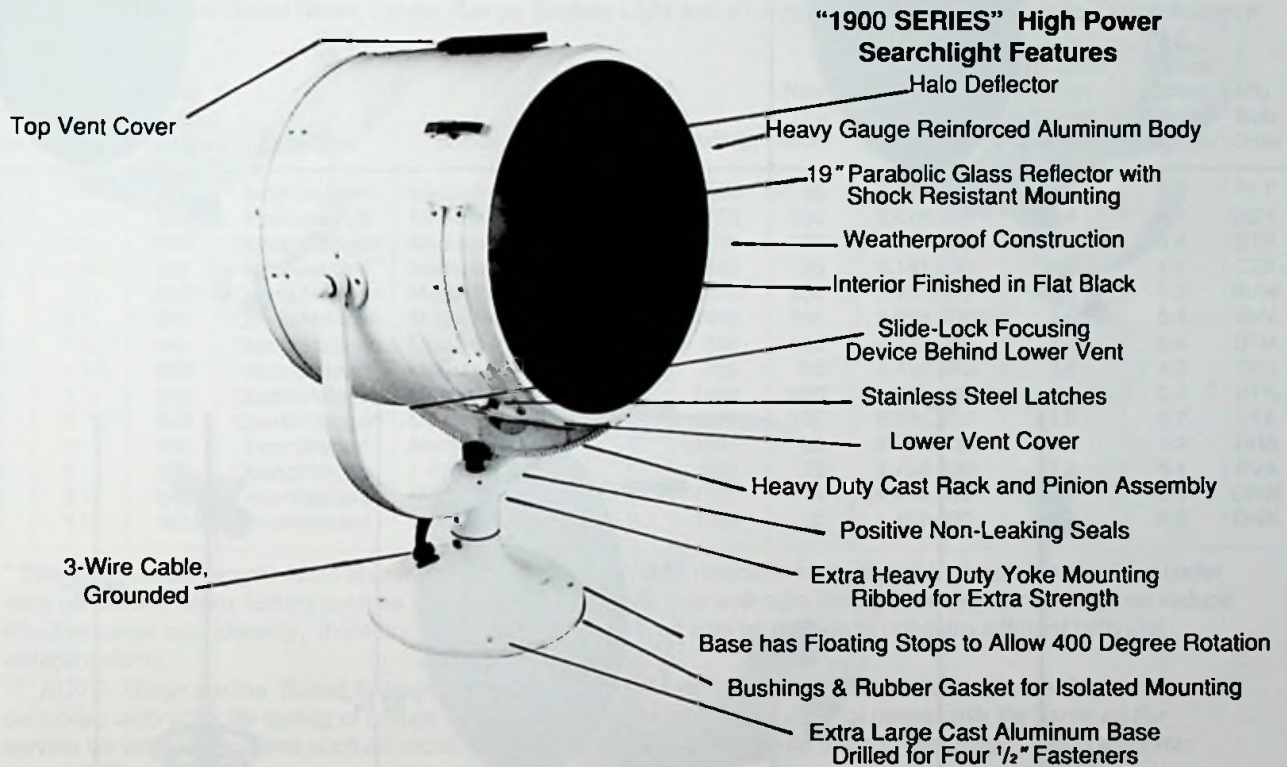

CONTROL TYPES

DECK CONTROL

Equipped with handles on the rear cover for positioning.

WHEEL CONTROL

Turn upper wheel for horizontal position. Turn lower wheel for vertical position.

LEVER/GEAR CONTROL

Aim handle for horizontal position. Twist handle for vertical position.

19 INCH SOLAR-RAY® SEARCHLIGHTS

Searchlight Dimensions

Nominal Drum Diameter Inches	Nominal Drum Weight Pounds	Nominal Control Weight Pounds
19	72	22

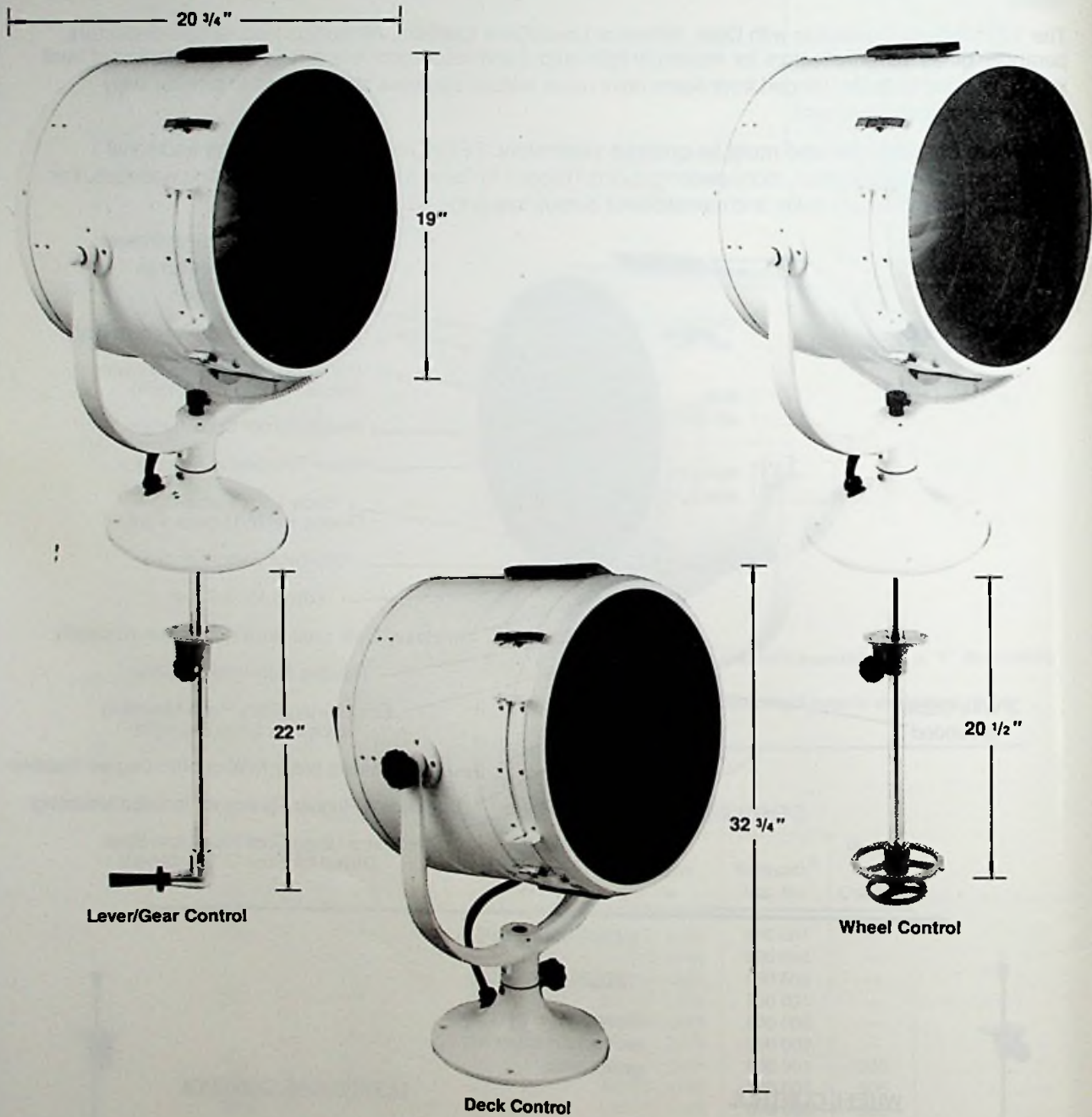

Base Diameter, 13 Inches
Distance Between Wheels, 2 1/2 Inches.

19 INCH SOLAR-RAY® SEARCHLIGHT HEAD AND CONTROL ASSEMBLIES ALL ALUMINUM • WHITE PERKO-KOTE

ORDERING INFORMATION

Description	Catalog No.
Deck Control Searchlight Head Assembly *	1901 004 WHT
Wheel or Lever/Gear Control Searchlight Head Assembly (Requires Control Assembly Below)	1902 004 WHT
Wheel Control Assembly (For Above)	1922 000 WHT
Lever/Gear Control Assembly (For Above)	1921 000 WHT

* Can Not Be Fitted With Controls.

Custom Control Lengths and Pedestal Heights Are Available. Price Upon Application. Specify Measurements.
BULBS ARE NOT INCLUDED IN LIGHTS

BULB ORDERING INFORMATION FOR 19 INCH SEARCHLIGHTS

To give good results, the bulb and reflector must be perfectly compatible; therefore be sure to specify the catalog number of the bulb desired. Peak candlepower is exceedingly sensitive to many factors, (i.e., a light source out of focus by 1/32 inch, under-voltage of only 4%, or differences between bulb manufacturers can cause a reduction of range of up to 20%).

For a More Concentrated Beam, Longer Range, Brighter Light and a Longer Life, We Recommend the Quartz/Halogen Bulbs.

Voltage	Approx. Range Miles*	Bulb Catalog Number	Bulb Type	Socket Type	Socket Code Letter	Wattage	Rated Life Hours**	Maximum Candlepower Output	Horizontal Beam Spread Degrees	Vertical Beam Spread Degrees	Mfg. Bulb Code
32	1 2/3	806	Incandescent	Medium Screw	B	500	50	3,520,000	3.5	3.7	DLT
120	1 3/8	837	Incandescent	Medium Prefocus	E	750	200	2,076,000	3.6	4.2	DDY
120	1 5/8	845	Quartz/Halogen	Medium Prefocus	E	750	200	2,871,000	3.6	5.4	BTP
120	1 5/8	807	Incandescent	Medium Prefocus	E	500	25	3,191,000	3.5	4.0	CZX
120	1 2/3	859	Quartz/Halogen	Mogul Prefocus	M	2000	250	3,633,000	9.4	5.9	BVW
120	1 2/3	847	Quartz/Halogen	Mogul Prefocus	M	1000	200	3,659,000	4.5	5.4	BVV
120	1 3/4	844	Quartz/Halogen	Medium Prefocus	E	500	100	4,212,000	3.0	5.4	BTM
120	1 3/4	809	Incandescent	Medium Prefocus	E	750	25	4,454,000	3.6	4.5	DPJ
120	1 7/8	846	Quartz/Halogen	Medium Prefocus	E	1000	200	4,601,000	4.5	5.4	BTR
120	2	848	Quartz/Halogen	Mogul Prefocus	L	1500	100	5,596,000	5.9	5.7	DTA
120	2	810	Incandescent	Medium Prefocus	E	1000	25	5,622,000	3.6	4.2	DRS
120	2	839	Quartz/Halogen	2-Pin Prefocus	K	900	75	5,769,000	5.9	5.4	BVA
120	2 1/8	840	Incandescent	Mogul Prefocus	L	1500	25	5,968,000	5.6	5.4	DRW
230	1 3/8	860	Incandescent	Medium Prefocus	E	1000	50	2,162,000	7.9	6.5	DWK

* The approximate ranges listed above are based on photometric measurements of beam candlepower output under ideal conditions. Many factors such as atmospheric conditions, size and color of target, background, etc., may reduce effective range considerably; therefore, these figures are offered only as a guide to compare different bulb and voltage options.

** NOTE: These are the "Rated Average Laboratory Life in Hours" of the Bulb Manufacturer obtained in closely controlled laboratory life testing of groups of lamps at their design voltage. It is not necessarily the same as the service life where conditions such as shock, vibration, voltage fluctuation and environment may result in a shorter average attained life.

ELECTRIC SOCKET AND SUPPORT STAND ASSEMBLIES FOR 19 INCH SEARCHLIGHTS

Solar-Ray® Searchlights include a socket and support stand based on the bulb or socket information given when ordering. The following chart makes it possible to order and stock different assemblies for field conversion, to meet a large variety of voltage and candlepower requirements with a minimum of inventory.

ORDERING INFORMATION

Socket Type	Socket Code	Socket & Stand Catalog Number	Height Stand Inches
Medium Screw	B	872 004	5 3/4
Medium Prefocus	E	873 004	5 7/16
Mogul Prefocus (1500 Watt)	L	1930 004	3 5/8
Mogul Prefocus (1000 & 2000 Watt)	M	1931 004	3 1/8
2-Pin Prefocus (900 Watt)	K	880 004	7 5/16

SPARE PARTS FOR 1900 SERIES SOLAR-RAY® SEARCHLIGHTS

ORDERING INFORMATION

Fig. No.	Front Glass Cat. No.	Front Door with Glass Cat. No.	Rear Cover Cat. No.	Reflector* Cat. No.	Pinion Gear Cat. No.
1901	889 004 CLR	1936 000 WHT	1932 000 WHT	890 004	---
1902	889 004 CLR	1936 000 WHT	1933 000 WHT	890 004	905
1903	889 004 CLR	1936 000 WHT	1933 000 WHT	890 004	905

* Replacement Retaining Clips (Cat. No. 911) for the Reflector Should Also Be Ordered When Ordering a Replacement Reflector to Assure a Proper Fit.

SPARE SOCKETS FOR 800 SERIES AND 1900 SERIES SOLAR-RAY® SEARCHLIGHTS

ORDERING INFORMATION



Medium Screw Socket
(Code "B")
Catalog No. 894.



Medium Prefocus Socket
(Code "E")
Catalog No. 895.

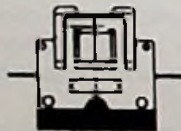

2-Pin Prefocus Socket
(Codes "F, G, H & I")
Catalog No. 899.

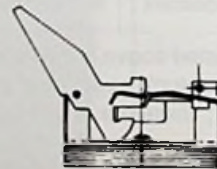

2-Pin Prefocus Socket
(Code "K")
Catalog No. 866.



Mogul Screw Socket
(Codes "D")
Catalog No. 897.

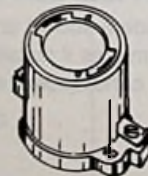

Mogul Prefocus Socket
(Codes "L & M")
Catalog No. 893.

* For Use In 10", 12" and 14" Searchlights Except When Catalog No. 839, 900 Watt Bulb is Used (Socket Codes "F, G, H & I").
** For Use In 12", 14" and 19" Searchlights Only When the Catalog No. 839, 900 Watt Bulb is Used.

VAPOR PROOF LIGHT FIXTURES

FIGS. 1087 & 1090

Satin Finish Die Cast Aluminum with Glass Globes.
Integral Junction Box with Four 1/2 Inch I.P.S. Fittings.

Fig. 1087, Ceiling Mount
Fig. 1090, Bulkhead Mount

Medium Screw Socket for Bulbs up to 100 Watts.
Bulb Not Included.



Fig. 1087



Fig. 1090

ORDERING INFORMATION

O.D. Box Inches	Length Overall Inches	Projection Inches	Standard Pkg.-1 pc.	Bolt Size	Weight Pounds
3 3/4	9 1/2	---	1087 000 ALU	1/4	3
3 3/4	10	7	1090 000 ALU	1/4	3 1/4



LISTED BY
UNDERWRITERS
LABORATORIES

Note: These Fixtures are listed in accordance with U.L. Standard 57, for enclosed gasketed fixtures.
Not evaluated for use in hazardous or explosive atmospheres.

Spare Guards, Cat. Nos. 1087 000 99A and 1090 000 99A.
Spare Sockets, Cat. Nos. 1087 000 99B and 1090 000 99B.

Spare Globes, Cat. Nos. 1087 000 99C and 1090 000 99C.

BULKHEAD MOUNT OIL LAMP

FIG. 141

Polished or Chrome Plated Brass
Gimbaled with Weighted Base

ORDERING INFORMATION

Height Overall Inches	Height Chimney Inches	Extension Overall Inches	Polished Brass Standard Pkg.-1 pc.	Chrome Plated Brass Standard Pkg.-1 pc.	Capacity Fount Fluid Ounces	Weight Pounds
10 1/2	4 5/8	5 1/2	141 001 POL	141 001 CHR	12	1 3/4



Fig. 141

Spare Chimney for Size No. 1, Cat. No. 230 000 CLR.
Spare Wick for Size No. 1, Cat. No. 302 00A.
Spare Burner for Size No. 1, Cat. No. 231 000 PLB or 231 000 CHR.

SMOKE BELL AND ARM

FIG. 128

Polished or Chrome Plated Brass
Fits Fig. No. 141, Both Sizes.

ORDERING INFORMATION

Polished Brass Std. Pkg.-1 pc.	Chrome Plated Brass Std. Pkg.-1 pc.	O.D. Bell Inches	Extension to Center Inches	Screw Size	Weight Ounces
128 001 POL	128 001 CHR	4	4	8	4



Fig. 128



Fig. 308

FLUSH MOUNT DOME LIGHT

FIG. 308

**Double Contact Bayonet Socket
Push Switch with Water Resistant Boot
Complete with 12 Volt Bulb.**

Chrome Plated Zinc

ORDERING INFORMATION

O.D. Globe Inches	O.D. Flange Inches	Depth Above Flange Inches	Depth Below Flange Inches	Max. Wattage	Display Pkg.-5 pcs. 1 Pc. per card	OEM Bulk Pkg. 10 pcs.	Screw Size	Weight Ounces
3	3 3/4	5/8	3/4	11	308 DP0 CHR	308 000 CHR	10 R.H.	5
4	4 1/2	3/4	1 1/4	17	308 DP1 CHR	308 001 CHR	10 R.H.	7
5	5 1/2	3/4	1 1/2	17	308 DP2 CHR	-----	12 R.H.	9

Spare Bulbs (2 per card) for 3 Inch Light, Cat. No. 337 011 DP.
Spare Bulbs (2 per card) for 4 Inch Light, Cat. No. 337 012 DP.
Spare Bulbs (2 per card) for 5 Inch Light, Cat. No. 337 013 DP.

Spare Switch, Cat. No. 701 DP.
Spare Socket, Cat. No. 24 DP1.
Spare Globe, Fig. No. 308 99A, Specify Size.

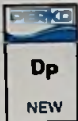

Fig. 300

SURFACE MOUNT DOME LIGHT

FIG. 300

**Double Contact Bayonet Socket
Push Switch with Water Resistant Boot
Complete with 12 Volt Bulb.**

Chrome Plated Zinc

ORDERING INFORMATION

O.D. Globe Inches	O.D. Base Inches	Depth Overall Inches	Max. Wattage	Display Pkg.-5 pcs. 1 Pc. per card	OEM Bulk Pkg. 10 pcs.	Screw Size	Weight Ounces
3	3 3/4	1 1/2	11	300 DP0 CHR	300 000 CHR*	10 R.H.	7
4	5	1 7/8	17	300 DP1 CHR	300 001 CHR	10 R.H.	9
5	6	2	17	300 DP2 CHR	300 002 CHR	12 R.H.	11

*OEM Bulk Pkg., 20 pcs.

Spare Bulbs (2 per card) for 3 Inch Light, Cat. No. 337 011 DP.
Spare Bulbs (2 per card) for 4 Inch Light, Cat. No. 337 012 DP.
Spare Bulbs (2 per card) for 5 Inch Light, Cat. No. 337 013 DP.

Spare Switch, Cat. No. 701 DP.
Spare Socket, Cat. No. 24 DP1.
Spare Globe, Fig. No. 257 DP, Specify Size.



Fig. 1253

EXTERIOR DOME LIGHT

FIG. 1253

**Double Contact Bayonet Socket
Push Switch with Water Resistant Boot
Complete with 12 Volt Bulb.**

**Ivory PERKO-KOTE Powder Coating
Black Vinyl Mounting Gasket**

ORDERING INFORMATION

O.D. Globe Inches	O.D. Base Inches	Depth Overall Inches	Max. Wattage	Display Pkg.-5 pcs. 1 Pc. per card	OEM Bulk Pkg. 10 pcs.	Screw Size	Weight Ounces
4	5	1 7/8	17	1253 DP1 WHT	1253 001 WHT	10 R.H.	9
5	6	2	17	1253 DP2 WHT	1253 002 WHT	12 R.H.	11

Spare Bulbs (2 per card) for 4 Inch Light, Cat. No. 337 012 DP.
Spare Bulbs (2 per card) for 5 Inch Light, Cat. No. 337 013 DP.
Spare Switch, Cat. No. 701 DP.

Spare Socket, Cat. No. 24 DP1.
Spare Globe, Fig. No. 257 DP, Specify Size.



SURFACE MOUNT DOME LIGHT

FIG. 1257

Unswitched
For Applications Utilizing Remote Switching.

Complete With 12 Volt, 10 Watt Bulb.

White Translucent Plastic Globe



Fig. 1257

ORDERING INFORMATION

O.D. Base	Depth Overall	Max. Wattage	Display Pkg. -5 pcs. 1 Pc. per card	OEM Bulk Pkg. 10 pcs.	Screw Size	Weight Ounces
3 3/4	1 1/4	10	1257 DP2 CHR	1257 002 CHR	8 R.H.	7

Spare Bulbs (2 per card), Cat. No. 70 DP0 CLR. Spare Globe, Cat. No. 244 002 WHT.



SURFACE MOUNT DOME LIGHT

FIG. 1258

Push Switch with Water Resistant Boot
Complete With 12 Volt, 10 Watt Bulb.

White Translucent Plastic Globe



Fig. 1258

ORDERING INFORMATION

O.D. Base	Depth Overall	Max. Wattage	Display Pkg. -5 pcs. 1 Pc. per card	OEM Bulk Pkg. 10 pcs.	Screw Size	Weight Ounces
3 3/4	1 1/4	10	1258 DP2 CHR	1258 002 CHR	8 R.H.	7

Spare Bulbs (2 per card), Cat. No. 70 DP0 CLR. Spare Switch, Cat. No. 701 DP. Spare Globe, Cat. No. 244 002 WHT.



SURFACE MOUNT DOME LIGHT

FIG. 1259

Unswitched
For Applications Utilizing Remote Switching.

Complete With 12 Volt, 10 Watt Bulb.

White Translucent Plastic Globe



Fig. 1259

ORDERING INFORMATION

Dimensions Base	Depth Overall	Max. Wattage	Display Pkg. -5 pcs. 1 Pc. per card	OEM Bulk Pkg. 10 pcs.	Screw Size	Weight Ounces
3 5/8 x 4 1/4	1 1/4	10	1259 DP2 CHR	1259 002 CHR	8 R.H.	10

Spare Bulbs (2 per card), Cat. No. 70 DP0 CLR. Spare Globe, Cat. No. 245 002 WHT.



SURFACE MOUNT DOME LIGHT

FIG. 1260

Push Switch with Water Resistant Boot
Complete With 12 Volt, 10 Watt Bulb.

White Translucent Plastic Globe

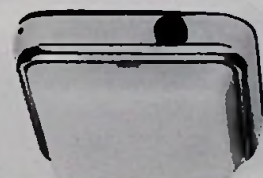

Fig. 1260

ORDERING INFORMATION

Dimensions Base	Depth Overall	Max. Wattage	Display Pkg. -5 pcs. 1 Pc. per card	OEM Bulk Pkg. 10 pcs.	Screw Size	Weight Ounces
3 5/8 x 4 1/4	1 1/4	10	1260 DP2 CHR	1260 002 CHR	8 R.H.	10

Spare Bulbs (2 per card), Cat. No. 70 DP0 CLR. Spare Switch, Cat. No. 701 DP. Spare Globe, Cat. No. 245 002 WHT.



NOTE: To Use The Lights on this Page in a 24 Volt System, Order Replacement Bulbs (2 per card) Cat. No. 67 DP1 CLR.

SURFACE MOUNT LIGHT FIG. 318A

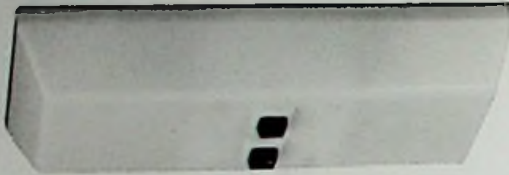

Fig. 318A

**Dual Voltage, For 12 and 120 Volts
Double Contact Bayonet Sockets,
Complete With Two 12 Volt and Two 120 Volt Bulbs.**

**White Translucent Plastic Globe
White PERKO-KOTE Cast Zinc Base
with Integral Junction Box**

ORDERING INFORMATION

Length Inches	Width Inches	Depth Inches	Display Pkg.-5 pcs. 1 Pc. per card	OEM Bulk Pkg. 10 pcs.	Screw Size	Weight Pounds
9 3/4	3 1/2	1 7/8	318 DP	318 A00	10	1 5/8



Spare 12 Volt Bulbs (2 per card), Cat. No. 337 012 DP.
Spare 120 Volt Bulbs (2 per card), Cat. No. 337 023 DP.
Spare Switches with Square Buttons (1 Each High and Low), Cat. No. 318 A00 99E.

Spare Socket, Cat. No. 24 DP1.
Spare Globe, Cat. No. 318 A00 99D.

SURFACE MOUNT DOME LIGHT FIG. 555



Fig. 555

**For Systems Up To 50 Volts.
Medium Screw Socket, Toggle Switch
Uses 15 Watt, A-17 Bulb, Not Included**

Chrome Plated Bronze

ORDERING INFORMATION

O.D. Globe Inches	O.D. Base Inches	Depth Inches	Standard Pkg.-1 pc.	Screw Size	Weight Pounds
6	7 7/8	3 1/8	555 000 CHR	8	4 1/2

Spare Switch, Cat. No. 514 DP.
Spare Socket, Cat. No. 1323.
Spare Globe, Cat. No. 257 DP6.

SURFACE MOUNT DOME LIGHT FIG. 753



Fig. 753

**For Systems Up To 50 Volts.
Medium Screw Sockets, Toggle Switches
Bulbs Not Included**

**Size No. 1 Has One Socket and Switch.
Will Accommodate a Bulb Up To 50 watts.
Size No. 2 Has Two Sockets and Switches.
Will Accommodate Bulbs Up To 25 watts.**

Chrome Plated Wrought Brass

ORDERING INFORMATION

O.D. Glass Inches	O.D. Base Inches	Depth Inches	Standard Pkg.-1 pc.	Screw Size	Weight Pounds
8	9 1/2	3	753 001 CHR	10	2 1/2
8	9 1/2	3	753 002 CHR	10	2 3/4

Spare Switch, Cat. No. 514 DP.
Spare Socket, Cat. No. 1323.
Spare Globe, Cat. No. 132 000 FRD.

ADJUSTABLE UTILITY LIGHT

FIG. 1254

Shield Swivels to Change Position

Complete With 12 Volt, 7 Watt Bulb

Chrome Plated Zinc



Fig. 1254

ORDERING INFORMATION

O.D. Overall Inches	Length Neck Inches	O.D. Neck Inches	Display Pkg.-5 pcs. 1 Pc. per card	OEM Bulk Pkg. 10 pcs.	Screw Size	Weight Ounces
2 5/8	3/4	7/8	1254 DP CHR	1254 000 CHR	6	6

Spare Bulbs (2 per card) . Cat. No. 337 011 DP.
Spare Socket, Cat. No. 24 DP1.



FIXED UTILITY LIGHT

FIG. 137

Complete with 12 Volt, 1 Watt Bulb

Shielded Utility Light

Molded Black Plastic



Fig. 137

ORDERING INFORMATION

Dimensions Inches	Display Pkg.-10 pcs. 1 Pc. per card	OEM Bulk Pkg. 100 pcs.	Screw Size	Weight Ounces
1 3/8 x 5/8	137 DP BLK	137 000 BLK	6	1/2



FIXED UTILITY LIGHT

FIG. 140

Complete with 12 Volt, 1 Watt Bulb

Diffused Utility Light

Molded White Plastic

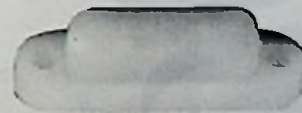

Fig. 140

ORDERING INFORMATION

Dimensions Inches	Display Pkg.-10 pcs. 1 Pc. per card	OEM Bulk Pkg. 100 pcs.	Screw Size	Weight Ounces
1 3/8 x 5/8	140 DP NYN	140 000 NYN	6	1/2





FIXED UTILITY LIGHT

FIG. 1044



Fig. 1044

No. 1 Supplied with 1/4" Spade Connectors
No. 2 Supplied with 7" Wire Leads

Complete with 12 Volt, 3 Watt Bulb.
Snap-On Front Cover Conceals Mounting Screws.

Molded Plastic, Black or White
Installs in a 1 3/4" Diameter Hole.

ORDERING INFORMATION

Color	Dimensions Inches	Depth Inches	Display Pkg.-10 pcs. 1 Pc. per card	OEM Bulk Pkg. 100 pcs.	Weight Ounces
Black	2 1/4 x 2 1/4	15/16	1044 DP1 BLK	1044 001 BLK	1
Black	2 1/4 x 2 1/4	15/16	1044 DP2 BLK	1044 002 BLK	1
White	2 1/4 x 2 1/4	15/16	1044 DP1 WHT	1044 001 WHT	1
White	2 1/4 x 2 1/4	15/16	1044 DP2 WHT	1044 002 WHT	1

Screw Size, No. 6.

Spare Bulb, Cat. No. 1044 000 99A.



FIXED UTILITY LIGHT

FIG. 1064



Fig. 1064

No. 1 Supplied with 1/4" Spade Connectors
No. 2 Supplied with 7" Wire Leads

Complete with 12 Volt, 3 Watt Bulb.

Molded Plastic, Black or White
Installs in a 1 3/4" Diameter Hole.

ORDERING INFORMATION

Color	Dimensions Inches	Depth Inches	Display Pkg.-10 pcs. 1 Pc. per card	OEM Bulk Pkg. 100 pcs.	Weight Ounces
Black	2 1/4 x 2 1/4	15/16	1064 DP1 BLK	1064 001 BLK	1
Black	2 1/4 x 2 1/4	15/16	1064 DP2 BLK	1064 002 BLK	1
White	2 1/4 x 2 1/4	15/16	1064 DP1 WHT	1064 001 WHT	1
White	2 1/4 x 2 1/4	15/16	1064 DP2 WHT	1064 002 WHT	1

Screw Size, No. 6.

Spare Bulb, Cat. No. 1044 000 99A.



ADJUSTABLE SPREADER LIGHT FIG. 1040

Complete with 12, 24 or 32 Volt Sealed Beam Unit.

Molded Black Plastic Body
Chrome Plated Brass Mounting Bracket



Fig. 1040

ORDERING INFORMATION

Voltage	O.D. Inches	Depth Inches	Dimensions		Display Pkg.-5 pcs. 1 Pc. per pkg.	OEM Bulk Pkg. 10 pcs.	Weight Pounds
			Bracket Inches	Bracket Inches			
12	4 1/2	4 1/2	4 1/2 x 1		1040 DP1 12V	1040 001 12V	1 1/2
24	4 1/2	4 1/2	4 1/2 x 1		1040 DP2 24V	1040 002 24V	1 1/2
32	4 1/2	4 1/2	4 1/2 x 1		1040 DP3 32V	1040 003 32V	1 1/2

Screw Size, No. 12 R.H.

Spare Sealed Beam Unit (12 Volt), Cat. No. 432 001 12V.
Spare Sealed Beam Unit (24 Volt), Cat. No. 432 002 24V
Spare Sealed Beam Unit (32 Volt), Cat. No. 432 003 32V



ADJUSTABLE SPREADER LIGHT FIG. 280

Complete with 12, 24 or 32 Volt Sealed Beam Unit.

Chrome Plated Brass



Fig. 280

ORDERING INFORMATION

Voltage	O.D. Inches	Depth Inches	Dimensions		Display Pkg.-5 pcs. 1 Pc. per pkg.	OEM Bulk Pkg. 10 pcs.	Weight Pounds
			Bracket Inches	Bracket Inches			
12	4 5/8	2 1/2	5 3/8 x 3/4		280 DP1 12V	280 001 12V	1 1/8
24	4 5/8	2 1/2	5 3/8 x 3/4		280 DP2 24V	280 002 24V	1 1/8
32	4 5/8	2 1/2	5 3/8 x 3/4		280 DP3 32V	280 003 32V	1 1/8

Screw Size, No. 12 R.H.

Spare Sealed Beam Unit (12 Volt), Cat. No. 432 001 12V.
Spare Sealed Beam Unit (24 Volt), Cat. No. 432 002 24V
Spare Sealed Beam Unit (32 Volt), Cat. No. 432 003 32V



FIXED SPREADER LIGHT FIG. 265

Complete with 12 Volt, 10 Watt Bulb

Chrome Plated Bronze



Fig. 265

ORDERING INFORMATION

O.D. Inches	Depth Inches	Display Pkg.-5 pcs. 1 Pc. per card	OEM Bulk Pkg. 10 pcs.	Screw Size	Weight Ounces
2 3/4	1 3/8	265 DP CHR	265 000 CHR	6	5

Spare Bulbs (2 per card), Cat. No. 70 DP0 CLR
Spare Socket Assembly, Cat. No. 265 000 99A.
Spare Lens with O-Ring, Cat. No. 284 DP CLR.



BULKHEAD LIGHT FIXTURES

FIGS. 217 & 1295



Fig. 217



Fig. 1295



For Systems up to 50 Volts.
Medium Screw Socket, Turn Switch

Fig. 1295 Has a Power Take-Off Receptacle
Bulb Not Included

Chrome Plated Zinc

ORDERING INFORMATION

Dimensions Base Inches	Projection Less Lamp Inches	Display Pkg.-5 pcs. 1 Pc. per card	Screw Size	Weight Ounces
2 1/2 x 1 3/4	2 5/8	217 DP CHR	6 R.H.	8
2 1/2 x 1 3/4	2 5/8	1295 DP CHR	6 R.H.	9

Spare Bulb Socket with Switch, Cat. No. 223.

BULKHEAD LIGHT FIXTURE

FIG. 450



Fig. 450



For Systems up to 50 Volts
Medium Screw Socket, Turn Switch
Bulb Not Included

Cast Bronze
Polished or Chrome Plated

ORDERING INFORMATION

Dimensions Base Inches	Projection Less Lamp Inches	Polished Bronze Display Pkg. -5 pcs.	Chrome Plated Bronze Display Pkg. -5 pcs.	Screw Size	Weight Ounces
2 1/2 x 2 1/4	2 1/2	450 DP POL	450 DP CHR	8 R.H.	11

Spare Bulb Socket with Switch, Cat. No. 223.

BULKHEAD LIGHT FIXTURE

FIG. 1303



Fig. 1303

For Systems up to 50 Volts.

Size No. 1 Has Double Contact Bayonet Socket.
Will Accommodate a Bulb Up To 24 Watts.

Size No. 2 Has Medium Screw Socket.
Will Accommodate a Bulb Up To 40 Watts.
Bulb Not Included

Molded Plastic, Black or White

ORDERING INFORMATION

Dimensions Wall Plate Inches	Normal Projection Inches	Length Shade Inches	Black Std. Pkg.-1 pc. OEM Pkg.-50 pcs.	White Std. Pkg.-1 pc. OEM Pkg.-50 pcs.	Screw Size	Weight Ounces
4 1/2 x 3 1/4	4 3/8	3	1303 001 BLK	1303 001 WHT	8	3
4 1/2 x 3 1/4	5	4 1/2	1303 002 BLK	1303 002 WHT	8	5

Spare Switch, Cat. No. 701 DP.

U.S.C.G. ELECTRICAL STANDARDS

JANUARY 31, 1977 THE U.S.C.G. PUBLISHED SAFETY STANDARDS FOR MARINE ELECTRICAL SYSTEMS. THESE STANDARDS COVER SUCH TECHNICAL DETAILS AS:

CONDUCTOR SIZE AND AMPACITY

STRAIN RELIEF AND PULL TESTS

TERMINATION REQUIREMENTS

OVERCURRENT PROTECTION

IGNITION PROTECTION

BATTERIES AND ASSOCIATED CONDUCTORS

GROUNDING

INSULATION

A particular electrical component may be affected by some or all of the above categories. Those categories related to product design have been complied with, however, many additional details must be considered by the installer of the equipment as well in order to achieve compliance with this standard. It is suggested that the actual standard be familiarized when installing equipment. Perhaps one of the most critical requirements is ignition protection. A product that is marked "Ignition Protected" can be used in that area of a boat that is not isolated from a gasoline fuel vapor source. Refer to the actual standard for a determination of what parts of a boat require Ignition Protected products. If a product is not plainly marked "Ignition Protected" then assume it is not.

FOR DETAILS ON ALL OF THE ABOVE, OBTAIN THE FOLLOWING:
U.S.C.G. SAFETY STANDARDS FOR ELECTRICAL SYSTEMS
CFR TITLE 33, CHAPTER 1, SUBCHAPTER S, PART 183, SUBPART I.

BATTERY SELECTOR SWITCHES

IGNITION PROTECTED

STANDARD FEATURES INCLUDE A MAKE BEFORE BREAK DESIGN, FOR USE WITH TWO OR MORE BATTERIES AND SINGLE OR DUAL ENGINE SYSTEMS*. THEY PERMIT SELECTION BETWEEN BATTERIES FOR STARTING AND CHARGING OR OPERATION OF BOTH BATTERIES IN PARALLEL. THEY ALLOW THE ADDITION OF AN EXTRA BATTERY FOR USE WITH ACCESSORIES. THE "OFF" POSITION ALSO ACTS AS AN EMERGENCY DISCONNECT IN THE EVENT OF AN ELECTRICAL PROBLEM. IN ADDITION SOME MODELS OFFER UNIQUE OPTIONS SUCH AS A KEYLOCK FOR EXTRA THEFT PROTECTION.

Protected by the following U.S. Patents; Design 260,637 - 4,280,028 - 4,424,424

Surface Mount, Red Plastic Housing with Large Black Plastic Knob. Incorporates an improved design to protect the copper contacts and brass terminals used as electrical connections.

For use with systems under 50 volts. Capacity — 250 AMPS Continuous, 360 AMPS Intermittent.

ORDERING INFORMATION

Features:	Display Pkg.-5 pkgs. 1 Pc. per pkg.	OEM Bulk Pkg. 25 pcs.	Diameter Inches	Depth Inches	Weight Pounds
Standard	8501 DP	8501	5 1/4	2 5/8	1
with Keylock	8502 DP	8502	5 1/4	2 5/8	1



Fig. 8501



Fig. 8502

*For Dual Engine Systems, two switches are required.

ALTERNATOR FIELD DISCONNECT MODELS

In addition to the standard features listed above the advantage these models feature is that they will prevent damage to the alternator* if accidentally switched to the "OFF" position while the engine is running.

ORDERING INFORMATION

Features:	Display Pkg.-5 pkgs. 1 Pc. per pkg.	OEM Bulk Pkg. 25 pcs.	Diameter Inches	Depth Inches	Weight Pounds
Standard	8503 DP	8503	5 1/4	2 5/8	1
with Keylock	8504 DP	8504	5 1/4	2 5/8	1

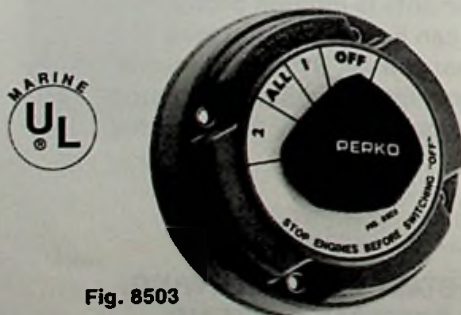

Fig. 8503



Fig. 8504

*When used with Non-Unitized Alternators, these models will interrupt the field current (reducing the possibility of damage) if turned "OFF" with the engine running.

MAIN BATTERY SWITCHES

IGNITION PROTECTED

These units are the same basic design and construction as our 8500 Series, except they are offered as main disconnect switches.

For use with systems under 50 volts.

Capacity — 250 AMPS Continuous, 360 AMPS Intermittent.

Protected by the following U.S. Patents; Design 260,637 - 4,280,028 - 4,424,424

ORDERING INFORMATION

Features:	Display Pkg.-5 pkgs. 1 Pc. per pkg.	OEM Bulk Pkg. 25 pcs.	Diameter Inches	Depth Inches	Weight Pounds
Standard	9601 DP	9601	5 1/4	2 5/8	1
with Keylock	9602 DP	9602	5 1/4	2 5/8	1



Fig. 9601



Fig. 9602



ALTERNATOR FIELD DISCONNECT MODELS

In addition to the standard features the advantage these models feature is that they will prevent damage to the alternator* if accidentally switched to the "OFF" position while the engine is running.

ORDERING INFORMATION

Features:	Display Pkg.-5 pkgs. 1 Pc. per pkg.	OEM Bulk Pkg. 25 pcs.	Diameter Inches	Depth Inches	Weight Pounds
Standard	9603 DP	9603	5 1/4	2 5/8	1
with Keylock	9604 DP	9604	5 1/4	2 5/8	1



Fig. 9603



Fig. 9604



*When used with Non-Unitized Alternators, these models will interrupt the field current (reducing the possibility of damage) if turned "OFF" with the engine running.



HEAVY DUTY BATTERY SELECTOR SWITCH

FIG. 8603

IGNITION PROTECTED

Make Before Break Design, For Use With Two or More Batteries and Single or Dual Engines. Alternator Field Disconnect to Prevent Damage to Alternator if Accidentally Switched to the "OFF" Position While Engine Is Running.

Fiber-Reinforced Polycarbonate Body
 1/2 Inch Diameter Brass Battery Terminals
 For Use With Systems Under 50 Volts.
 Capacity — 380 AMPS Continuous, 850 AMPS Intermittent



Fig. 8603



ORDERING INFORMATION			
Dimensions	Face	Depth	Display Pkg.-2 pkgs.
	Inches	Inches	1 Pc. per pkg.
	5 1/4 x 5 1/4	3 3/8	8603 DP
			Weight Pounds
			3



BATTERY SELECTOR SWITCHES WITH REMOTE INDICATOR PANEL

IGNITION PROTECTED

These units have the same basic features and construction as Figs. 8501 & 8502 plus provisions for use with a remote indicator panel. For use with systems under 50 volts. Indicator panel supplied with 12 volt lamps only
 Capacity — 250 AMPS Continuous, 360 AMPS Intermittent

Protected by the following U.S. Patents; Design 260,367 - 4,280,028 - 4,424,424

ORDERING INFORMATION					
Features:	Display Pkg.-5 pkgs.	OEM Bulk Pkg.	Diameter	Depth	Weight
	1 Pc. per pkg.	25 pcs.	Inches	Inches	Pounds
Standard	8505 DP	8505	5 1/4	2 5/8	1
with Keylock	8506 DP	8506	5 1/4	2 5/8	1



Fig. 8505



Fig. 8506



These Switches are Designed to Meet Federal Specification-Ambulance (KKK-A-1822B).

IGNITION STARTER SWITCH FIG. 310

3 Position: Off-Ign/Run-Start.
Rated for 15 Amps at 12, 24 and 32 Volts.
Automatically Returns From Start to Run Position.
Chrome Plated Brass Face Nut with Plain Brass Body

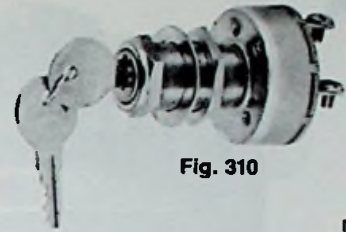

Fig. 310

For Max. Dash Thickness Inches			ORDERING INFORMATION		
Diameter Neck Inches	Length Overall Inches		Display Pkg.-10 pcs. 1 Pc. per card	Weight Ounces	
1	1 3/16	2 3/4	310 DP CHR	4 1/2	



PUSH-PULL SWITCH FIG. 105

2 Position: Off-On.
Rated for 15 Amps at 12, 24 and 32 Volts
Chrome Plated Brass Face Nut and Plastic Knob with Plain Brass Body

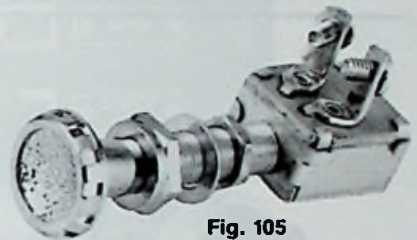

Fig. 105

For Max. Dash Thickness Inches			ORDERING INFORMATION		
Diameter Neck Inches	Length Overall Inches		Display Pkg.-10 pcs. 1 Pc. per card	OEM Bulk Pkg. 50 pcs.	Weight Ounces
1	3/8	3	105 DP1 CHR	105 001 CHR	2 1/2



PUSH-PULL SWITCH FIG. 366

3 Position: 2 Circuit, Off-On-On.
Rated for 15 Amps at 12, 24 and 32 Volts
 For use with Combination Masthead/All-Round Lights together with running lights. Second "On" Position turns off running lights and turns on both compartments of Masthead/All-Round Light.

Chrome Plated Brass Face Nut and Plastic Knob with Plain Brass Body



Fig. 366

For Max. Dash Thickness Inches			ORDERING INFORMATION		
Diameter Neck Inches	Length Overall Inches		Display Pkg.-10 pcs. 1 Pc. per card	Weight Ounces	
1	3/8	3 3/4	366 DP CHR	3 1/4	



PUSH-PULL SWITCH FIG. 381

3 Position: Off-On-On.
Rated for 15 Amps at 12, 24 and 32 Volts
 First "On" Position Energizes One Terminal
 Second "On" Position Energizes Both Terminals
Chrome Plated Brass Face Nut and Plastic Knob with Plain Brass Body



Fig. 381

For Max. Dash Thickness Inches			ORDERING INFORMATION		
Diameter Neck Inches	Length Overall Inches		Display Pkg.-10 pcs. 1 Pc. per card	Weight Ounces	
1	3/8	3 3/4	381 DP CHR	3 1/4	



Important Note: None of the above Switches are Ignition Protected. See Page 73.

MOMENTARY SWITCH FIG. 255



Single Pole
Rated for 15 Amps at 12, 24 and 32 Volts

Chrome Plated Brass Button and Face Nut
with Plain Brass Body

ORDERING INFORMATION



Fig. 255

For Max. Dash Thickness Inches	Diameter Neck Inches	Length Overall Inches	Display Pkg.-10 pcs. 1 Pc. per card	OEM Bulk Pkg. 50 pcs.	Weight Ounces
7/8	5/8	2 3/4	255 DP CHR	255 000 CHR	2 1/2

MOMENTARY SWITCH FIG. 306

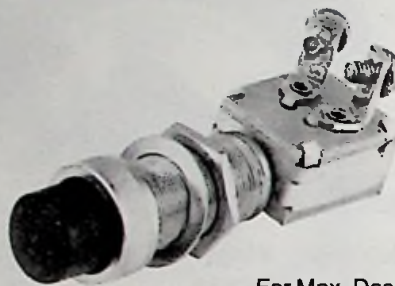

Single Pole
Rated for 15 Amps at 12, 24 and 32 Volts

Chrome Plated Brass Button with Weather Resistant Cover and Plain Brass Body

ORDERING INFORMATION



Fig. 306

For Max. Dash Thickness Inches	Diameter Neck Inches	Length Overall Inches	Display Pkg.-10 pcs. 1 Pc. per card	OEM Bulk Pkg. 50 pcs.	Weight Ounces
1	5/8	2 3/4	306 DP CHR	306 000 CHR	3

PUSH BUTTON SWITCH FIG. 701



Push-On, Push-Off
Rated for 4 Amps at 12, 24 and 32 Volts

Black Plastic with Weather Resistant Cover

ORDERING INFORMATION



Fig. 701

Maximum Thickness of Panel	Diameter Neck Inches	Display Pkg.-10 bags 1 Pc. per bag	Weight Ounces
1/8	3/8	701 DP	1/2

PUSH BUTTON SWITCH FIG. 703



Push-On, Push-Off
Rated for 2 Amps at 12, 24 and 32 Volts

Nickel Plated Button with Brushed Aluminum Face Nut and Weather Resistant Cover

ORDERING INFORMATION



Fig. 703

Maximum Thickness of Panel	Diameter Neck Inches	Display Pkg.-10 bags 1 Pc. per bag	Weight Ounces
1/8	3/8	703 DP NKL	1/2

Important Note: None of the above Switches are Ignition Protected. See Page 73.



SWITCH PANEL

FIG. 517

BLACK PLASTIC

Rated for 10 Amps at 12, 24 and 32 Volts.

For 1/4" x 1 1/4" Fuses.

Complete with Rocker Switches,
Name Plates and Low Profile
Fuse Holders for 1/4" x 1 1/4" Fuses.

Will Mount on Curved or Flat Surfaces,
Textured Finish,
Engraved Lettering



Fig. 517

ORDERING INFORMATION

Dimensions Inches	Display Pkg.-5 pcs. 1 Pc. per card	Weight Ounces
6 1/2 x 4 1/2	517 DP BLK	8

Screw Size #6

Spare Rocker Switches, Cat. No. 531 DP.
Spare Fuse Holders, Cat. No. 532 DP.

Spare Fuse Holder Cap. Cat. No. 558 DP.



TOGGLE SWITCH

FIG. 514

Single Pole, Single Throw (Off-On).
Rated for 6 Amps at 12, 24 and 32 Volts.

Nickel Plated Brass Toggle
with Chrome Plated Face Nut



Fig. 514

ORDERING INFORMATION

Maximum Thickness of Panel Inches	Diameter Neck Inches	Display Pkg.-10 pcs. 1 Pc. per bag	Weight Ounces
5/16	7/16	514 DP	3/4



TOGGLE SWITCH

FIG. 688

Single Pole, Single Throw (Off-On).
Rated for 20 Amps at 12, 24 and 32 Volts.

Nickel Plated Brass Toggle
with Chrome Plated Face Nut

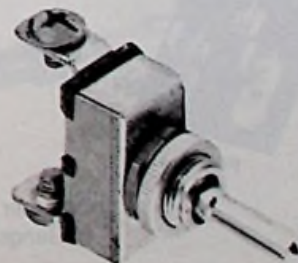

Fig. 688

ORDERING INFORMATION

Maximum Thickness of Panel Inches	Diameter Neck Inches	Display Pkg.-10 pcs. 1 Pc. per bag	Weight Ounces
3/16	7/16	688 DP NKL	1



Important Note: None of the above Switches are Ignition Protected. See Page 73.



Fig. 626

FUSE PANELS

FIG. 626

Rated for 20 Amps at 12, 24 and 32 Volts
For 1/4" x 1 1/4" Fuses

Molded Plastic Base with Brass Hardware

ORDERING INFORMATION

Number of Gangs	Display Pkg. -5 bags 1 Pc. per bag	OEM Bulk Pkg. 50 pcs.	Dimensions Inches	Weight Ounces
3	626 003 DP	626 003	2 1/4 x 2 7/16 x 3/16	2
4	626 004 DP	626 004	3 x 2 7/16 x 3/16	2 1/4
5	626 005 DP	626 005	3 3/4 x 2 7/16 x 3/16	2 1/2
6	626 006 DP	626 006	4 1/2 x 2 7/16 x 3/16	2 3/4



Fig. 629

FUSE PANELS

FIG. 629

Rated for 20 Amps at 12, 24 and 32 Volts
For 1/4" x 1 1/4" Fuses

Single Bus Bar
Molded Plastic Base with Brass Hardware

ORDERING INFORMATION

Number of Gangs	Display Pkg. -5 bags 1 Pc. per bag	OEM Bulk Pkg. 50 pcs.	Dimensions Inches	Weight Ounces
4	629 004 DP	629 004	3 x 2 7/16 x 3/16	2
6	629 006 DP	629 006	4 1/2 x 2 7/16 x 3/16	3
8	629 008 DP	629 008	6 x 2 7/16 x 3/16	3
12	629 012 DP	629 012*	9 x 2 7/16 x 3/16	6 1/2

*OEM Bulk Pkg., 25 pcs.



Fig. 694

FUSE PANEL

FIG. 694

Rated for 20 Amps at 12, 24 and 32 Volts
For 1/4" x 1 1/4" Fuses

Includes Center Clip for Spare Fuse.
Molded Plastic Base with Brass Hardware

ORDERING INFORMATION

Number of Gangs	Display Pkg. -5 pcs. 1 Pc. per bag	OEM Bulk Pkg. 50 pcs.	Dimensions Inches	Weight Ounces
2	694 DP	694	2 7/16 x 1 1/2 x 3/16	1 1/2



Important Note: All of the Above Items Conform to U.S.C.G. Electrical Standards. See Page 73.

COMBINATION FUSE & TERMINAL BLOCK FIG. 647

Rated for 20 Amps at 12, 24 and 32 Volts
For 1/4" x 1 1/4" Fuses

With Binding Posts
Molded Plastic Base and Brass Hardware



Fig. 647

ORDERING INFORMATION

Number of Gangs	Display Pkg.-5 pcs. 1 Pc. per bag	OEM Bulk Pkg. 50 pcs.	Dimensions Inches	Weight Ounces
4	647 004 DP	647 004	3 x 3 5/16 x 3/16	3 1/2
6	647 006 DP	647 006	4 1/2 x 3 5/16 x 3/16	5
8	647 008 DP	647 008	6 x 3 5/16 x 3/16	7
12	647 012 DP	647 012*	9 x 3 5/16 x 3/16	11

* OEM Bulk Pkg., 25 pcs.



TERMINAL BLOCKS FIG. 627

Rated for 30 Amps at 12, 24 and 32 Volts

Molded Plastic Base with Brass Hardware



Fig. 627

ORDERING INFORMATION

Number of Gangs	Display Pkg.-5 pcs. 1 Pc. per bag	OEM Bulk Pkg. 50 pcs.	Dimensions Inches	Weight Ounces
2	627 002 DP	627 002	1 1/2 x 1 1/2 x 3/16	1
4	627 004 DP	627 004	3 x 1 1/2 x 3/16	2
6	627 006 DP	627 006	4 1/2 x 1 1/2 x 3/16	2 1/4



IN-LINE FUSEHOLDER FIG. 786

Rated for 20 Amps at 12, 24 and 32 Volts
For 1/4" x 1 1/4" Fuses

Complete with 12 Volt, 20 Amp Fuse
and 7 1/2 inch Wire Lead.

Molded Plastic

ORDERING INFORMATION

Length Inches	Diameter Inches	Display Pkg.-10 pcs. 1 Pc. per bag	OEM Bulk Pkg. 50 pcs.	Weight Ounces
2 1/8	11/16	786 DP	786	3/4

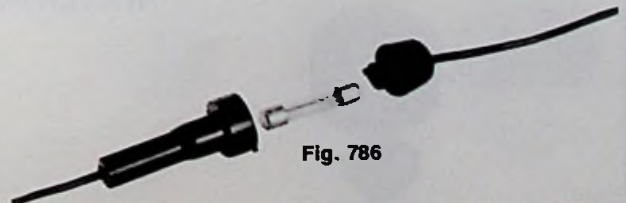

Fig. 786



Important Note: All of the Above Items Conform to U.S.C.G. Electrical Standards. See Page 73.

FLAT LINE CONNECTORS

FIG. 720

Fig. 720-2

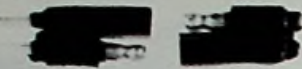

Fig. 720-3

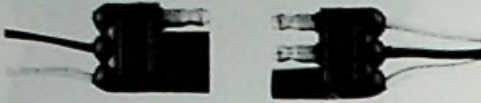

Fig. 720-4 — Shrouded



Rated for 15 Amps at 12, 24 and 32 Volts
Polarized
Both Sides Have 12 Inch, 18 Gauge Color Coded Wire Leads.

Molded Plastic Bodies with Brass Contacts

ORDERING INFORMATION

Number of Poles	Display Pkg.-5 pcs. 1 Pc. per bag	Width Inches	Weight Ounces
2	720 DP2	5/8	1
3	720 DP3	7/8	1 1/2
4	*720 DP4	1 1/8	2

* All contacts are shrouded.

WATERTIGHT DECK CONNECTIONS

FIGS. 1189 & 1190



Rated for 15 Amps at 12, 24 and 32 Volts.
Polarized Double Contact Connector

Fig. 1189, Chrome Plated Brass
Fig. 1190, Chrome Plated Zinc

Flange Gasket with Integral Waterproof Cap
For Base When Plug is Removed.

ORDERING INFORMATION

Fig. 1189 — Chrome Plated Brass
Fig. 1190 — Chrome Plated Zinc

Diameter Inches	Height Inches	Display Pkg.-10 pcs. 1 Pc. per card	OEM Bulk Pkg. 50 pcs.	Screw Size	Weight Ounces
1 5/8	1 3/16	1189 DP CHR	1189 000 CHR	4	2 1/2
1 5/8	1 3/16	1190 DP CHR	1190 000 CHR	4	2 1/2

Spare Connector with Cover, Cat. No. 1189 DP 99A

Spare Connector Only, Cat. No. 42.

Note: These Items Are Not Ignition Protected.



Important Note: All of the Above Items Conform to U.S.C.G. Electrical Standards. See Page 73.

WATERTIGHT CABLE OUTLETS

FIGS. 424 & 1191



For 5/16 Inch O.D. Cable

Fig. 424, Chrome Plated Brass
Fig. 1191, Chrome Plated Zinc

Equipped with Rubber Grommet
for Watertight Passage of Cable.

ORDERING INFORMATION

Fig. 424 — Chrome Plated Brass
Fig. 1191 — Chrome Plated Zinc

Diameter Base Inches	Display Pkg.-10 pcs. 1 Pc. per card	Screw Size	Weight Ounces
1 1/4	424 DP CHR	4	1
1 1/4	1191 DP CHR	4	1



BRASS CABLE STRAPS FIG. 121

For Cable, Tubing, Control Wire, Etc.

ORDERING INFORMATION

I.D. Inches	Length Inches	Display Pkg.-10 bags 10 Pcs. per bag
1/8	1 7/16	121 DP1 PLB
3/16	1 3/8	121 DP2 PLB
1/4	1 5/16	121 DP3 PLB
5/16	1 3/4	121 DP4 PLB
3/8	1 5/8	121 DP5 PLB
7/16	1 5/8	121 DP6 PLB
1/2	1 1/2	121 DP7 PLB
5/8	1 3/4	121 DP8 PLB
3/4	1 7/8	121 DP9 PLB



Fig. 121

Width all sizes — 1/2 inch.

Note: This Item Conforms to U.S.C.G. Fuel Standards.



PLASTIC CABLE STRAPS FIG. 196

Black Plastic, Ultra-Violet Stabilized for Weather Resistance. Eliminates the Need for Insulating Cushion.

ORDERING INFORMATION

I.D. Inches	Display Pkg.-10 bags 10 Pcs. per bag	OEM Pkg.-500 pcs.
3/16	196 DP1	196 001
1/4	196 DP2	196 002
5/16	196 DP3	196 003
3/8	196 DP4	196 004
1/2	196 DP5	196 005
5/8	196 DP6	196 006
3/4	196 DP7	196 007



Fig. 196

Width All Sizes — 1/2 inch.

NOTE: This Item Conforms to U.S.C.G. Electrical Standards.



LINE SUPPORT CLIPS FIGS. 163, 164 & 165

Aluminum with Synthetic Rubber Cushion



ORDERING INFORMATION

For O.D. Line Inches	Width Inches	Single Display Pkg.-10 bags 10 Pcs. per bag	Double Display Pkg.-10 bags 10 Pcs. per bag	Triple Display Pkg.-10 bags 10 Pcs. per bag	Fig. 163 Single	Fig. 164 Double	Fig. 165 Triple
3/16	3/8	163 DP1 ALU	164 DP1 ALU	-----			
1/4	3/8	163 DP2 ALU	164 DP2 ALU	-----			
5/16	1/2	163 DP3 ALU*	164 DP3 ALU	165 DP3 ALU			
3/8	1/2	163 DP4 ALU*	164 DP4 ALU	165 DP4 ALU			
1/2	1/2	163 DP5 ALU	164 DP5 ALU*	165 DP5 ALU*			
5/8	1/2	163 DP6 ALU*	-----	-----			

*OEM Package -500 pcs. Replace "DP" With "00" When Ordering.

Note: This Item Conforms to U.S.C.G. Electrical and Fuel Standards.



DOUBLE CONTACT BAYONET BASE BULB FIG. 337

CLEAR



Fig. 337



ORDERING INFORMATION

Nominal Voltage	Wattage	Amps	Display Pkg. 5 cards	Bulbs per card	Bulb Diameter Inches	Mfr. Lamp No.
12	7	.58	337 011 DP	2	3/4	90
12	11	.94	337 012 DP	2	3/4	1004
12	17	1.44	337 013 DP	2	1	1142
24	15	.63	337 014 DP	1	1	306
32	12	.37	337 018 DP	1	3/4	624
32	14	.45	337 019 DP	1	1	1228
32	20	.61	337 020 DP	1	1	1692
32	24	.74	337 021 DP	1	1 3/8	1054
120	15	---	337 023 DP	2	7/8	15T7

DOUBLE ENDED - FESTOON BULBS FIGS. 67, 69, 70, 71 & 72

CLEAR

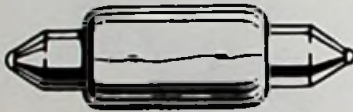

Fig. 67
Fig. 69
Fig. 70
Fig. 71
Fig. 72

Rust-Proof Nickel Plated Brass Caps

ORDERING INFORMATION

Nominal Voltage	Wattage	Amps	Display Pkg.-5 cards 2 Bulbs per card	Bulb Diameter Inches	Bulb Length Inches
12	10	.83	69 DP CLR	3/8	1 5/8
12	10	.74	70 DP0 CLR	3/8	1 11/16
12	13	.97	70 DP1 CLR	9/16	1 11/16
12	10	.80	71 DP CLR	3/8	1 1/8
24	10	.42	67 DP1 CLR	3/8	1 11/16
24	18	.75	67 DP2 CLR	9/16	1 11/16
24	10	.40	72 DP1 CLR	3/8	1 1/8
32	13	.40	70 DP2 CLR	3/8	1 5/8



MEDIUM SCREW BASE BULB FIG. 340

FROSTED



Fig. 340

ORDERING INFORMATION

Nominal Voltage	Wattage	Amps	Standard Pkg.- 6 bulbs	Type	L.C.L. Inches	Mfr. Lamp No.
12	15	1.25	340 005 FRD	A-17	2 3/8	15-A
12	25	2.08	340 006 FRD	A-19	2 9/16	25-A
12	50	4.16	340 007 FRD	A-21	3 7/16	50-A21
32	15	.47	340 011 FRD	A-17	2 3/8	15-A
32	25	.78	*340 012 FRD	A-19	2 9/16	25-A
32	50	1.56	*340 013 FRD	A-21	3 7/16	50-A21

*Standard Pkg.- 2 bulbs



NOTE: High Power Bulbs and Sealed Beam Units For Searchlights, See Searchlight Section.

ELECTRIC BULBS ARE NOT RETURNABLE. ORDER CAREFULLY.

CHROMALEX® COWL VENTILATOR FIG. 1312

Chrome Plated Zinc Cowl with Black Plastic Base

3 Inch Duct Threads into Neck, Hose Clamps Not Required

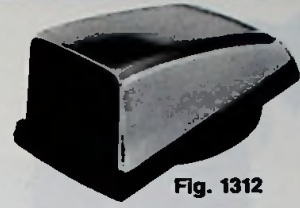

Fig. 1312

Mouth Opening				ORDERING INFORMATION			
Square Inches	Length Overall Inches	Width Overall Inches	Height Overall Inches	Display Pkg.-5 pcs. 1 Pc. per card	OEM Bulk Pkg. 50 pcs.	Screw Size	Weight Ounces
7	5 3/4	4 3/8	2 5/8	1312 DP CHR	1312 000 CHR	8	12



COWL VENTILATOR FIG. 870

Chrome Plated Zinc

3 Inch Duct Threads into Neck, Hose Clamps Not Required



Fig. 870

Mouth Opening				ORDERING INFORMATION		
Square Inches	Length Overall Inches	Width Overall Inches	Height Overall Inches	Standard Pkg.-5 pcs.	Screw Size	Weight Ounces
7	5 1/4	4	2 3/4	870 000 CHR	10	21

COWL VENTILATOR FIG. 510

Polished or Chrome Plated Brass
Cast Bronze Deck Plate

Internal Thumb Screw Allows Cowl To Be Locked In Any Position.
Ventilators Are Painted White Inside Only.

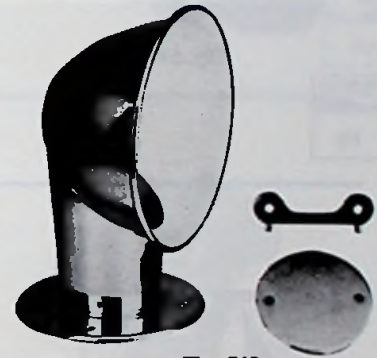

Fig. 510

Mouth Opening				ORDERING INFORMATION		Screw Size	Weight Pounds
I.D. Deck Plate Inches	O.D. Deck Plate Inches	Diameter Mouth Inches	Height Overall Inches	Polished Brass Standard Pkg.-1 pc.	Chrome Plated Brass Standard Pkg.-1 pc.		
4	7 1/16	8	11	510 004 POL	510 004 CHR	10	6 3/8
5	8 3/8	10	13	510 005 POL	510 005 CHR	10	9 3/8

For Spare Deck Plates, Covers and Keys; Refer to Fig. No. 526, Page 101.

CLAM SHELL VENTILATOR FIG. 315

Chrome Plated Brass



Fig. 315

Dimensions		Height	Width	ORDERING INFORMATION		Screw Size	Weight Ounces
Base Inches	Opening Inches	Opening Inches	Display Pkg.-10 pcs. 1 Pc. per card	OEM Bulk Pkg. 100 pcs.			
1 5/8 x 1 1/2	7/16	7/8	315 DP1 CHR	315 001 CHR	4	1/2	
2 x 2	9/16	1 1/8	315 DP2 CHR	315 002 CHR	6	1 1/4	



CLAM SHELL VENTILATOR FIG. 339

Chrome Plated Brass



Fig. 339

Dimensions		Height	Width	ORDERING INFORMATION		Screw Size	Weight Ounces
Base Inches	Opening Inches	Opening Inches	Display Pkg.-5 pcs. 1 Pc. per card	OEM Bulk Pkg. 25 pcs.			
4 x 3 3/4	1 5/8	2 1/2	339 DP CHR	339 000 CHR	6	5 1/2	



GAS TANK VENT

FIG. 570



Fig. 570



**Chrome Plated Zinc
With Black or White Plastic Cap and
Removable 30 Mesh, Monel Wire Screen Flame Arrester.**

ORDERING INFORMATION

	Hose Size Inches	Max. Hull Thickness Inches	Display Pkg.-10 pcs. 1 Pc. per card	OEM Bulk Pkg. 50 pcs.	Weight Ounces
Color					
Black	5/8	3/4	570 DP4 BLK	570 004 BLK	3
White	5/8	3/4	570 DP4 WHT	570 004 WHT	3

GAS TANK VENT WITH SWIVEL ELBOW

FIG. 571

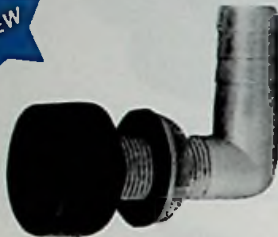

Fig. 571



**Black or White Plastic Cap With Zinc Elbow and
Removable 30 Mesh, Monel Wire Screen Flame Arrester.**

Design Allows Elbow to be Rotated to any Position.

ORDERING INFORMATION

	Hose Size Inches	Max. Hull Thickness Inches	Display Pkg.-10 pcs. 1 Pc. per card	OEM Bulk Pkg. 50 pcs.	Weight Ounces
Color					
Black	5/8	3/4	571 DP4 BLK	571 004 BLK	3
White	5/8	3/4	571 DP4 WHT	571 004 WHT	3

GAS TANK VENT WITH SWIVEL ELBOW

FIG. 561



Fig. 561



**Chrome Plated Zinc Cap With Zinc Elbow,
Black Plastic Splash Guard and
Removable 30 Mesh, Monel Wire Screen Flame Arrester.**

Design Allows Elbow to be Rotated to any Position.

ORDERING INFORMATION

	Hose Size Inches	Max. Hull Thickness Inches	Display Pkg.-10 pcs. 1 Pc. per card	OEM Bulk Pkg. 50 pcs.	Weight Ounces
	5/8	1	561 DP4 CHR	561 004 CHR	3 1/4

Spare Splash Guard, Cat. No. 518 000 BLK.

GAS TANK VENT

FIG. 506



Fig. 506



**Chrome Plated Zinc
With Black Plastic Splash Guard and
Removable 30 Mesh, Monel Wire Screen Flame Arrester.**

ORDERING INFORMATION

	Hose Size Inches	Max. Hull Thickness Inches	Display Pkg.-10 pcs. 1 Pc. per card	OEM Bulk Pkg. 100 pcs.	Weight Ounces
	5/8	3/4	506 DP4 CHR	506 004 CHR	2 1/2

Spare Splash Guard, Cat. No. 518 000 BLK.

NOTE: ALL OF THE ABOVE VENTS ARE DESIGNED TO MEET THE REQUIREMENTS OF U.S.C.G. SAFETY STANDARDS JANUARY 31, 1977, FOR GASOLINE FUEL SYSTEMS.

GAS TANK VENT

FIG. 509

Chrome Plated Bronze
With Removable 30 Mesh, Monel Wire Screen Flame Arrester.



Fig. 509

ORDERING INFORMATION

Hose Size Inches	Max. Hull Thickness Inches	Display Pkg.-5 pcs. 1 Pc. per card	OEM Bulk Pkg. 50 pcs.	Weight Ounces
5/8	3/4	509 DP4 CHR	509 004 CHR	4
3/4	5/8	509 DP5 CHR	509 005 CHR	6



GAS TANK VENT

FIG. 503

Chrome Plated Bronze
With Removable 30 Mesh, Monel Wire Screen Flame Arrester.



Fig. 503

ORDERING INFORMATION

Thread Size Inches	Max. Hull Thickness Inches	Display Pkg.-5 pcs. 1 Pc. per card	OEM Bulk Pkg. 50 pcs.	Weight Ounces
3/8	7/8	503 DP3 CHR	503 003 CHR	5 1/2
1/2	7/8	503 DP4 CHR	503 004 CHR	6



GAS TANK VENT

FIG. 515

Chrome Plated Bronze
With Removable 30 Mesh, Monel Wire Screen Flame Arrester.



Fig. 515

ORDERING INFORMATION

Thread Size Inches	Max. Hull Thickness Inches	Display Pkg.-5 pcs. 1 Pc. per card	OEM Bulk Pkg. 50 pcs.	Weight Ounces
3/8	5/8	515 DP3 CHR	515 003 CHR	3
1/2	5/8	515 DP4 CHR	515 004 CHR	4



GAS TANK VENT

FIG. 505

Chrome Plated Cast Bronze
With Removable 30 Mesh, Monel Wire Screen Flame Arrester.



Fig. 505

Designed to meet the requirements of the National Fire Protection Assn. Booklet No. 302, Section No. 323 on vent pipe outlets.
 The 1/2" N.P.T. is off center to create a water baffle.

ORDERING INFORMATION

O.D. Flange Inches	O.D. Neck Inches	Length Neck Inches	Display Pkg.-5 pcs. 1 Pc. per card	OEM Bulk Pkg. 25 pcs.	Screw Size	Weight Ounces
2 1/2	1 3/16	1 1/2	505 DP CHR	505 000 CHR	8	6 1/2



NOTE: ALL OF THE ABOVE VENTS ARE DESIGNED TO MEET THE REQUIREMENTS OF U.S.C.G. SAFETY STANDARDS JANUARY 31, 1977, FOR GASOLINE FUEL SYSTEMS.

LOCKER VENTILATOR FIG. 330



Fig. 330



Chrome Plated Brass

ORDERING INFORMATION

O.D. Inches	Display Pkg.-10 pcs. 1 Pc. per card	OEM Bulk Pkg. 100 pcs.	Screw Size	Weight Ounces
2 1/2	330 DP1 CHR	330 001 CHR	6 R.H.	3/4
3 1/4	330 DP2 CHR	330 002 CHR	6 R.H.	1

TRANSOM OR LOCKER VENTILATOR FIG. 550

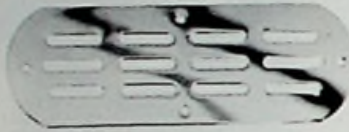

Fig. 550



Chrome Plated Brass

ORDERING INFORMATION

Dimensions Inches	Display Pkg.-10 pcs. 1 Pc. per card	OEM Bulk Pkg. 25 pcs.	Screw Size	Weight Ounces
7 x 2 1/2	550 DP CHR	550 000 CHR	8	3

TRANSOM OR LOCKER VENTILATOR FIG. 1271

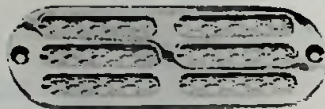

Fig. 1271



Chrome Plated Zinc
With Anodized Aluminum Grill Type Screen.

ORDERING INFORMATION

Dimensions Inches	Display Pkg.-10 pcs. 1 Pc. per card	OEM Bulk Pkg. 25 pcs.	Screw Size	Weight Ounces
6 x 2	1271 DP CHR	1271 000 CHR	8	3

TRANSOM OR LOCKER VENTILATOR FIG. 1238



Fig. 1238



Chrome Plated Zinc
With Anodized Aluminum Grill Type Screen.

ORDERING INFORMATION

Dimensions Inches	Display Pkg.-10 pcs. 1 Pc. per card	OEM Bulk Pkg. 50 pcs.	Screw Size	Weight Ounces
8 3/8 x 2 1/4	1238 DP CHR	1238 000 CHR	8	4

LOUVER VENTILATOR FIG. 334

Chrome Plated Brass

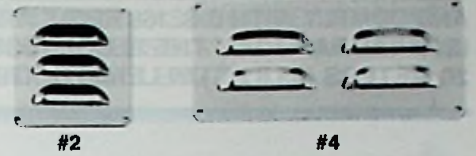

ORDERING INFORMATION

Dimensions Inches	Length Louvers Inches	Display Pkg.-5 pcs. 1 Pc. per card	OEM Bulk Pkg. 10 pcs.	Weight Ounces
3 x 2 1/2	2	334 002 DP	334 002 CHR	1 1/5
4 x 2 1/2	3	334 02A DP	334 02A CHR	1 4/5
5 1/2 x 2 1/2	2	334 004 DP	334 004 CHR	2 1/2
7 1/2 x 2 1/2	3	334 04A DP	334 04A CHR	3 1/5
8 x 2 1/2	2	334 006 DP	334 006 CHR	3 1/2
11 x 2 1/2	3	334 06A DP	334 06A CHR	4 1/2

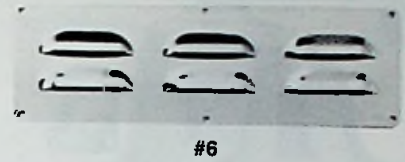

Fig. 334



Screw Size #4 R.H.

LOUVER VENTILATOR FIG. 335

Chrome Plated Brass

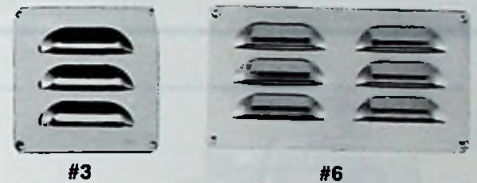

ORDERING INFORMATION

Dimensions Inches	Length Louvers Inches	Display Pkg.-5 pcs. 1 Pc. per card	OEM Bulk Pkg. 10 pcs.	Weight Ounces
3 x 3	2	335 003 DP	335 003 CHR	1 1/2
4 x 3 1/2	3	335 03A DP	335 03A CHR	2
5 1/2 x 3	2	335 006 DP	335 006 CHR	3
7 1/2 x 3 1/2	3	335 06A DP	335 06A CHR	4 1/2
8 x 3	2	335 009 DP	335 009 CHR	4
11 x 3 1/2	3	335 09A DP	335 09A CHR	6 1/2

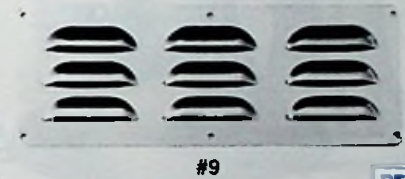

Fig. 335



Screw Size #4 R.H.

LOUVER VENTILATOR FIG. 336

Chrome Plated Brass

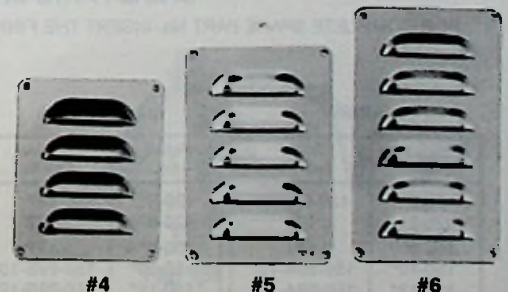

ORDERING INFORMATION

Dimensions Inches	Length Louvers Inches	Display Pkg.-5 pcs. 1 Pc. per card	OEM Bulk Pkg. 10 pcs.	Weight Ounces
3 3/4 x 3	2	336 004 DP	336 004 CHR	2
4 3/8 x 4	3	336 04A DP	336 04A CHR	3
4 1/2 x 3	2	336 005 DP	336 005 CHR	2 1/2
5 3/8 x 4	3	336 05A DP	336 05A CHR	3 4/5
5 1/4 x 3	2	336 006 DP	336 006 CHR	2 4/5
6 3/8 x 4	3	336 06A DP	336 06A CHR	4 1/3

Fig. 336

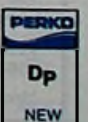

Screw Size #4 R.H.

THE 8, 10, AND 12 INCH BELLS LISTED ON THIS PAGE HAVE BEEN REVIEWED BY THE U.S. COAST GUARD AND COMPLY WITH C.G. 169 REGULATIONS FOR SOUND SIGNAL APPLIANCES AS REQUIRED BY ANNEX III PARAGRAPH 2 OF THE 72 COLREGS. THE 8 AND 10 INCH SIZES ARE FOR USE ON VESSELS UNDER 20 METERS (65.6 FT.) IN LENGTH. THE 12 INCH SIZE IS FOR USE ON VESSELS OF ANY LENGTH.

FOG BELL FIG. 420

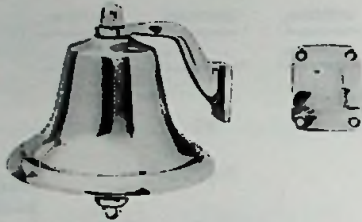

Fig. 420

Cast Bronze

Polished or Chrome Plated Bronze
Medium Weight, Removable

ORDERING INFORMATION

Bottom Diameter Inches	Height Overall Inches	Polished Bronze Std. Pkg.-1 pc.	Chrome Plated Bronze Std. Pkg.-1 pc.	Weight Pounds
6	5	420 006 POL	420 006 CHR	4¼
8	6⅞	420 008 POL	420 008 CHR	7⅞

Screw Size #8 F.H.

FOG BELL FIG. 150

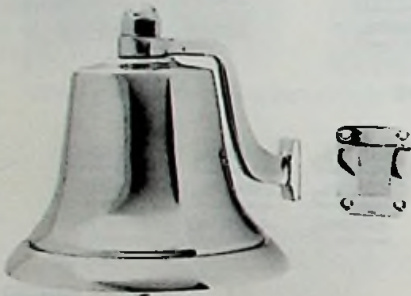

Fig. 150

Cast Bronze

Plain, Polished, or Chrome Plated Bronze
Heavy Weight, Removable

ORDERING INFORMATION

Bottom Diameter Inches	Height Overall Inches	Plain Bronze Std. Pkg.-1 pc.	Polished Bronze Std. Pkg.-1 pc.	Chrome Plated Bronze Std. Pkg.-1 pc.	Weight Pounds
8	8	150 008 PLB	150 008 POL	150 008 CHR	11
10	10½	150 010 PLB	150 010 POL	150 010 CHR	20½
12	12	150 012 PLB	150 012 POL	150 012 CHR	28¼

Screw Size ¼" F.H.

SPARE PARTS ORDERING INFORMATION FOR PAGES 92 & 93.

FOR COMPLETE SPARE PART No. INSERT THE FINISH CODE: P or PLB, for Plain Bronze or Brass Finish (i.e. 420 P06 99A or 127 000 PLB)
B or POL, for Polished Bronze or Brass Finish (i.e. 420 B06 99A or 127 000 POL)
C or CHR, for Chrome Plated Finish (i.e. 420 C06 99A or 127 000 CHR)

ARMS		WALL PLATES		CLAPPERS		EYE BOLTS		ACORN NUTS	
Figure No.	Spare Part No.	Figure No.	Spare Part No.	Figure No.	Spare Part No.	Figure No.	Spare Part No.	Figure No.	Spare Part No.
420-6"	420-99A-6"	420-6"	127	420-6"	153	420-6"	113	420-6"	465 004
420-8"	171	420-8"	127	420-8"	144	420-8"	123	420-8"	465 008
150-8"	171	150-8"	127	150-8"	144	150-8"	123	150-8"	465 008
150-10"	150-99A-10"	150-10"	150-99B-10"	150-10"	150-99C	*150-10"	150-99D	150-10"	465 009
150-12"	150-99A-12"	*150-12"	150-99B-12"	*150-12"	172	*150-12"	172	150-12"	465 009
*158-12"	158-99A-12"	*158-12"	158-99A-12"	*158-12"	172	*158-12"	172	158-12"	465 009
*158-14"	158-99A-14"	*158-14"	158-99A-14"	*158-14"	172	*158-14"	172	158-14"	465 009
179	179 000 99A	*179	179 000 99A	179	144	179	179-99B	179	465 008
159-6"	159-99A	159-6"	166	159-6"	159-99B	159-6"	113	159-6"	465 004
159-8"	159-99A	159-8"	166	159-8"	153	159-8"	113	159-8"	465 004
*Includes Wall Bracket		*Includes Arm		*Includes Eye Bolt		*Includes Clapper			

THE 8 AND 12 INCH BELLS LISTED ON THIS PAGE HAVE BEEN REVIEWED BY THE U.S. COAST GUARD AND COMPLY WITH C.G. 169 REGULATIONS FOR SOUND SIGNAL APPLIANCES AS REQUIRED BY ANNEX III PARAGRAPH 2 OF THE 72 COLREGS. THE 8 INCH SIZE IS FOR USE ON VESSELS UNDER 20 METERS (65.6 FT.) IN LENGTH. THE 12 INCH SIZE IS FOR USE ON VESSELS OF ANY LENGTH.

FOG BELL FIG. 158

Cast Bronze

Plain, Polished or Chrome Plated Bronze
Heavy Weight, Fixed Mounting



Fig. 158

ORDERING INFORMATION

Bottom Diameter Inches	Height Overall Inches	Plain Bronze Std. Pkg.-1 pc.	Polished Bronze Std. Pkg.-1 pc.	Chrome Plated Bronze Std. Pkg.-1 pc.	Weight Pounds
12	12	158 012 PLB	158 012 POL	158 012 CHR	29 2/3

Bolt Size 1/4" R.H.

FOG BELL FIG. 179

Wrought Brass

Plain Brass
Light Weight, Fixed Mounting



Fig. 179

ORDERING INFORMATION

Bottom Diameter Inches	Height Overall Inches	Standard Pkg.-1 pc.	Weight Pounds
12	8	179 012 PLB	7 3/4

Screw Size #12 R.H.

FOG BELL FIG. 159

Stamped Brass

Plain or Chrome Plated Brass
Light Weight, Removable

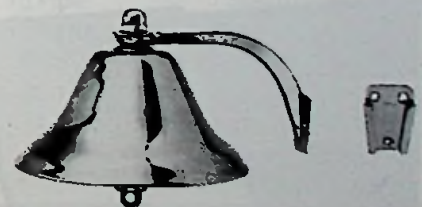

Fig. 159

ORDERING INFORMATION

Bottom Diameter Inches	Height Overall Inches	Chrome Plated Display Pkg.-2 pcs. 1 Pc. per pkg.	Plain Brass Display Pkg.-2 pcs. 1 Pc. per pkg.	Weight Pounds
6	4	159 DP6 CHR	159 DP6 PLB	1 1/2
8	5	159 DP8 CHR	159 DP8 PLB	2 3/4

Screw Size #4 R.H.



NOTE: FIGS. 162 & 349 CONFORM TO A.B.Y.C. STANDARD A-23 IN ACCORDANCE WITH THE 72 COLREGS AND U.S. INLAND RULES FOR USE ON VESSELS UNDER 5 METERS (16.4 ft) IN LENGTH.

FOG HORN FIG. 162

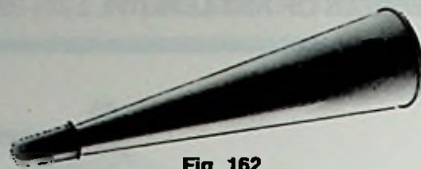

Fig. 162



**Aluminum with White Baked Enamel Finish
Nylon Mouthpiece**

ORDERING INFORMATION

Length Inches	Display Pkg. -5 pcs. 1 Pc. per bag	Weight Ounces
12 1/2	162 DP WHT	6

"BALL TYPE" WHISTLE FIG. 349



Fig. 349



Orange Plastic

ORDERING INFORMATION

Length Inches	Width Inches	Display Pkg. -10 pcs. 1 Pc. per card	OEM Bulk Pkg. 100 pcs.	Weight Ounces
2 1/4	3/4	349 DP	349	1 1/2

PORTLIGHT CHAIN FIG. 441



Fig. 441



Stainless Steel Chain with Chrome Plated Fittings

ORDERING INFORMATION

Length Inches	Length Strap Inches	Display Pkg. -5 pcs. 1 Pc. per card	OEM Bulk Pkg. 50 pcs.	Screw Size	Weight Ounces
7	1 7/8	441 DP CHR	441 000 CHR	8	2

PORTLIGHT WEATHERSTRIPPING FIG. 461



Fig. 461

Open Cell Foam Rubber

Supplied in Ten Foot Lengths.

ORDERING INFORMATION

Height Inches	Min. Width Inches	Max. Width Inches	Standard Pkg. -1 lgth.
9/16	7/16	5/8	461

YACHT LOG BOOK FIG. 708

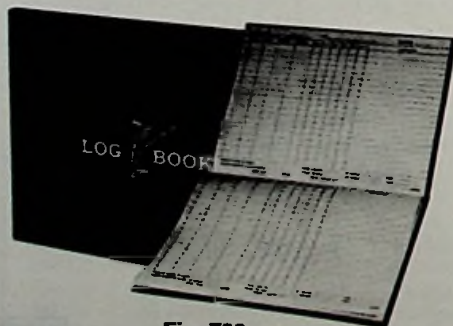

Fig. 708



112 Pages 8 1/4" x 11"

Cover is hard plastic coated with a water resistant washable finish. Navy blue with gold lettering. In addition to pages for log data, these books contain useful information such as extracts from Bowditch Practical Navigator on symbols for weather, state of sea, cloud formations, force of wind, guest log and marine telephone log.

ORDERING INFORMATION

Display Pkg. -5 pcs. 1 Pc. per bag	Weight Ounces
708 DP	18

INTAKE WATER STRAINERS FIGS. 493 & 500

CAST BRONZE

PERKO WATER STRAINERS ARE DESIGNED FOR EASY INSTALLATION AND CLEANING. FEATURES INCLUDE MOUNTING LUGS CAST INTO BOTH SIDES TO ASSURE UNIVERSAL MOUNTING, FOUR OUTSIDE TIE RODS AND A 304 STAINLESS STEEL STRAINER BASKET TO MINIMIZE ELECTROLYSIS. HINGED LUGS FOR THE CAST BRONZE COVER PERMIT EASY REMOVAL AND CLEANING OF THE STRAINER BASKET. A DRAIN PLUG IN THE BOTTOM CASTING IS PROVIDED FOR EASILY REMOVING SEDIMENT AND DRAINING FOR WINTERIZING.

FOR APPLICATIONS REQUIRING HIGHER CAPACITY SEE FIG. 500 BELOW.



Fig. 493

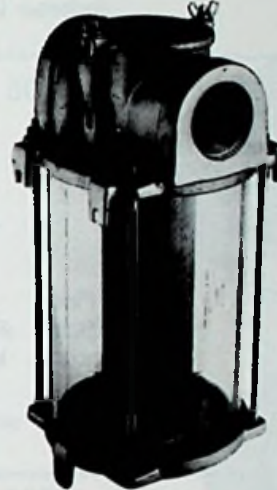

Fig. 500



ORDERING INFORMATION

FIG. 493

Pipe Size Inches	Height Overall Inches	Width Overall Inches	Standard Pkg.-1 pc.	Dimensions Cylinder Inches	Dimensions Basket Inches	Open Area To Pipe Size Ratio	Weight Pounds	Spare Gasket Kit* Display Pkg.-5 kts. 1 Kt. per pkg.
3/8	4 1/4	3 1/4	493 003 PLB	2 3/4 x 2 1/2	1 3/16 x 2 3/4	22:1	2 1/2	493 DP3 99M
1/2	5 3/4	4 1/2	493 004 PLB	3 1/2 x 4	1 13/16 x 4 3/8	30:1	5	493 DP4 99M
3/4	8 3/8	4 1/2	493 005 PLB	3 1/2 x 6	1 13/16 x 6 1/4	25:1	5	493 DP5 99M
1	9 1/2	5 1/2	493 006 PLB	4 1/2 x 5 1/2	2 5/8 x 5 7/8	20:1	8	493 DP6 99M
1 1/4	10	5 1/2	493 007 PLB	4 1/2 x 6	2 5/8 x 6 1/4	13:1	8	493 DP7 99M
1 1/2	11 1/2	7 1/4	493 008 PLB	6 x 8	3 5/16 x 8 7/16	17:1	14	493 DP8 99M
2	16	7 1/2	493 009 PLB	6 x 12	3 5/16 x 12 1/4	13:1	18	493 DP9 99M
2 1/2	16	7 1/2	493 010 PLB	6 x 12	3 5/16 x 12 1/2	10:1	18	493 DPX 99M

ORDERING INFORMATION

FIG. 500

Pipe Size Inches	Height Overall Inches	Width Overall Inches	Standard Pkg.-1 pc.	Dimensions Cylinder Inches	Dimensions Basket Inches	Open Area To Pipe Size Ratio	Weight Pounds	Spare Gasket Kit* Standard Pkg.-1 kit
2	14 1/2	9	500 009 PLB	8 x 10	3 7/8 x 10 1/4	20:1	34	500 009 99M
2 1/2	16 1/2	9	500 010 PLB	8 x 12	3 7/8 x 12 1/4	18:1	34	500 010 99M
3	18 1/2	9	500 011 PLB	8 x 14	3 7/8 x 14 1/4	14:1	34	500 011 99M

*Spare Gasket Kit Consists of: 1 - Cover Gasket and 2 - Cylinder Gaskets.

SPARE PARTS ORDERING INFORMATION

For Spare Part No. Insert a Spare Part Code Listed Below in Place of the "PLB" in the Strainer's Catalog Number (i.e., 493 006 99A, Top Casting for 1" Strainer).

Top Casting	99A	Cover with Gasket	99E	Cover Gaskets (2 per bag)	99N
Bottom Casing	99B	Hinged Bolt for Cover		Tie Rods, Nuts and Washers	99P
Transparent Cylinder	99C	With Pin, Nut and Washer	99L	Consists of:	
Basket Strainer	99D			(4 of Each for 493 Series)	
				(1 of Each for 500 Series)	

DECK PLATES FOR PIPE FIG. 528

**Cast Bronze
Plain or Chrome Plated**

Complete with Fig. No. 1248 Key and O-Ring.
1 1/4 and 1 1/2 Inch Caps Have a Slot Between the Holes.

ORDERING INFORMATION For Unmarked Deck Plates



Fig. 528

Pipe Size Inches	O.D. Flange Inches	Plain Bronze Std. Pkg.-1 pc.	Chrome Plated Bronze Std. Pkg.-1 pc.	Chrome Plated Bronze OEM Bulk Pkg. 10 pcs.	Weight Ounces
1	2 7/8	528 006 PLB	528 006 CHR	-----	12
1 1/4	3 5/16	528 007 PLB	528 007 CHR	-----	12
1 1/2	3 5/8	528 008 PLB	*528 DP8 CHR	528 008 CHR	16
2	4 1/4	528 009 PLB	528 009 CHR	-----	33 1/2
2 1/2	4 5/8	528 010 PLB	528 010 CHR	-----	33 1/2
3	5 3/8	528 011 PLB	528 011 CHR	-----	43 1/2

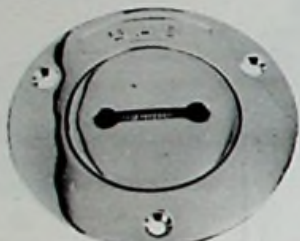

Fig. 528-G

****ORDERING INFORMATION For Gas Deck Plates**

Pipe Size Inches	O.D. Flange Inches	Plain Bronze Std. Pkg.-1 pc.	Chrome Plated Bronze Std. Pkg.-1 pc.	Chrome Plated Bronze OEM Bulk Pkg. 10 pcs.	Weight Ounces
1 1/4	3 5/16	528 G07 PLB	528 G07 CHR	-----	12
1 1/2	3 5/8	528 G08 PLB	*528 DPG CHR	528 G08 CHR	16
2	4 1/4	528 G09 PLB	528 G09 CHR	528 G09 CHR	33 1/2

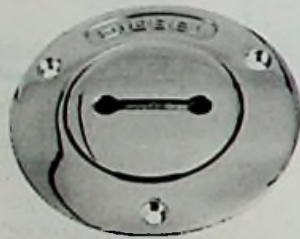

Fig. 528-D

ORDERING INFORMATION For Diesel Deck Plates

Pipe Size Inches	O.D. Flange Inches	Plain Bronze Std. Pkg.-1 pc.	Chrome Plated Bronze Std. Pkg.-1 pc.	Chrome Plated Bronze OEM Bulk Pkg. 10 pcs.	Weight Ounces
1 1/4	3 5/16	528 D07 PLB	528 D07 CHR	-----	12
1 1/2	3 5/8	528 D08 PLB	*528 DPD CHR	528 D08 CHR	16
2	4 1/4	528 D09 PLB	528 D09 CHR	-----	33 1/2



Fig. 528-W

ORDERING INFORMATION For Water Deck Plates

Pipe Size Inches	O.D. Flange Inches	Plain Bronze Std. Pkg.-1 pc.	Chrome Plated Bronze Std. Pkg.-1 pc.	Chrome Plated Bronze OEM Bulk Pkg. 10 pcs.	Weight Ounces
1 1/4	3 5/16	528 W07 PLB	528 W07 CHR	528 W07 CHR	12
1 1/2	3 5/8	528 W08 PLB	*528 DPW CHR	528 W08 CHR	16
2	4 1/4	528 W09 PLB	528 W09 CHR	-----	33 1/2

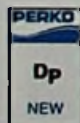

* Display Pack -5 pcs. (1 Pc. per card)

Screw Sizes: 2 1/2 and 3 Inch Deck Plates #10, All Others #8.

****NOTE:** These Deck Plates Meet the Requirements of U.S.C.G. Safety Standards, January 31, 1977, for Gasoline Fuel Systems, 33CFR183.

SPARE PARTS ORDERING INFORMATION

Pipe Size Inches	Plain Bronze Cap*	Chrome Plated Bronze Cap*	O-Rings Only (2 per bag)	Spare Key
1	528 P06 99A	528 C06 99A	513 006	1248 006 ZNC
1 1/4	528 P07 99A	528 C07 99A	513 007	1248 7-8 DP***
1 1/2	528 P08 99A	528 DP8 99A**	513 008	1248 7-8 DP***
2	528 P09 99A	528 C09 99A	513 009	1248 009 ZNC
2 1/2	528 P10 99A	528 C10 99A	513 010	1248 010 ZNC
3	528 P11 99A	528 C11 99A	513 011	528 011 99C

* Complete With O-Ring.

** Display Pkg.-5 pcs. (1 Pc. per card).

*** Display Pkg.-10 pcs. (1 Pc. per card).

WASTE DECK PLATE FOR PIPE FIG. 524

Chrome Plated Bronze

Complete with Fig. No. 1248 Key and O-Ring
Cap Has a Slot Between the Holes.



Fig. 524

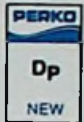

ORDERING INFORMATION

Pipe Size	O.D. Flange Inches	Length Neck Inches	Display Pkg. -5 pcs. 1 Pc. per card	OEM Bulk Pkg. 10 pcs.	Screw Size	Weight Ounces
1 1/2	3 5/8	3 1/2	524 DP CHR	524 000 CHR	8	16

Spare Cap with O-Ring, Cat. No. 524 DP 99A. Spare O-Rings Only (2 per bag), Cat. No. 513 008.
Spare Key, Cat. No. 1248 7-8 DP.

WASTE DECK PLATE FOR HOSE FIG. 507

Chrome Plated Bronze

Complete with Fig. No. 1248 Key and O-Ring
Cap Has a Slot Between the Holes.



Fig. 507



ORDERING INFORMATION

Hose Size	O.D. Flange Inches	Length Neck Inches	Display Pkg. -5 pcs. 1 Pc. per card	OEM Bulk Pkg. 50 pcs.	Screw Size	Weight Ounces
1 1/2	3 1/8	3 1/2	507 DP CHR	507 000 CHR	8	14

Spare Cap with O-Ring, Cat. No. 507 DP 99A. Spare O-Rings Only (2 per bag), Cat. No. 513 008.
Spare Key, Cat. No. 1248 7-8 DP.

WASTE DECK PLATE FOR HOSE FIG. 508

Chrome Plated Bronze Black Plastic Cap

Complete with Fig. No. 1248 Key and O-Ring
Cap Has a Slot Between the Holes.



Fig. 508



ORDERING INFORMATION

Hose Size	O.D. Flange Inches	Length Neck Inches	Display Pkg. -5 pcs. 1 Pc. per card	OEM Bulk Pkg. 50 pcs.	Screw Size	Weight Ounces
1 1/2	3 1/8	3 1/2	508 DP CHR	508 000 CHR	8	11

Spare Cap with O-Ring, Cat. No. 508 DP 99A. Spare O-Rings Only (2 per bag), Cat. No. 513 008.
Spare Key, Cat. No. 1248 7-8 DP.

WASTE DECK PLATE FOR HOSE FIG. 1269

Chrome Plated Zinc Black Plastic Cap

Complete with Fig. No. 1248 Key and O-Ring
Cap Has a Slot Between the Holes.



Fig. 1269



ORDERING INFORMATION

Hose Size	O.D. Flange Inches	Length Neck Inches	Display Pkg. -5 pcs. 1 Pc. per card	OEM Bulk Pkg. 50 pcs.	Screw Size	Weight Ounces
1 1/2	3 1/2	2 1/2	1269 DP CHR	1269 000 CHR	8	8

Spare Cap with O-Ring, Cat. No. 1269 DP 99A. Spare O-Rings Only (2 per bag), Cat. No. 513 008.
Spare Key, Cat. No. 1248 7-8 DP.

NOTE: These Items Comply with Adopted Standards on "Fittings" A.B.Y.C. Recommended Practices Standards Covering Sewage Holding and/or Treatment Devices for Marine Waste Systems.



DECK PLATES FOR HOSE FIG. 527



Fig. 527

Chrome Plated Bronze 35° Angled Hose Bibs

Complete with Fig. No. 1247 Key,
O-Ring and Fig. No. 537 Retaining Cable on Cap.
Caps Have a Slot Between the Holes.

ORDERING INFORMATION

Marked For:	Hose Size Inches	O.D. Flange Inches	Length Neck Inches	Standard Pkg.-1 pc.	Screw Size	Weight Pounds
*Gas	1 1/2	3 1/2	4 7/8	527 G08 CHR	10	2 3/8
Diesel	1 1/2	3 1/2	4 7/8	527 D08 CHR	10	2 3/8
Water	1 1/2	3 1/2	4 7/8	527 W08 CHR	10	2 3/8
**Waste	1 1/2	3 1/2	4 7/8	527 HT8 CHR	10	2 3/8

Spare Cap with O-Ring, Cat. No. 528 DP8 99A. Spare O-Rings Only (2 per bag), Cat. No. 513 008.
Spare Key, Cat. No. 1247 DP CHR.

** Waste Deck Plate Does Not Include A Retaining Cable.

DECK PLATES FOR HOSE FIG. 520



Fig. 520

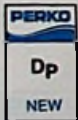

Chrome Plated Bronze

Complete with Fig. No. 1248 Key,
O-Ring and Integral Retainer on Cap.
Caps Have a Slot Between the Holes.

ORDERING INFORMATION

Marked For:	Hose Size Inches	O.D. Flange Inches	Length Neck Inches	Display Pkg.-5 pcs. 1 Pc. per card	OEM Bulk Pkg. 50 pcs.	Screw Size	Weight Ounces
*Gas	1 1/2	3 1/8	3 1/2	520 DPG CHR	520 G00 CHR	8	14
Diesel	1 1/2	3 1/8	3 1/2	520 DPD CHR	520 D00 CHR	8	14
Water	1 1/2	3 1/8	3 1/2	520 DPW CHR	520 W00 CHR	8	14

Spare Cap with O-Ring and Retainer, Cat. No. 520 DP 99A. Spare O-Rings Only (2 per bag), Cat. No. 513 008.
Spare Key, Cat. No. 1248 7-8 DP.

DECK PLATES FOR HOSE FIG. 521

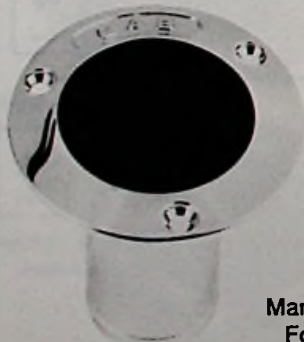
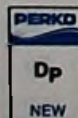

Fig. 521



Chrome Plated Bronze Black Plastic Cap

Complete with Fig. No. 1248 Key,
O-Ring and Integral Retainer on Cap.
Caps Have a Slot Between the Holes.

ORDERING INFORMATION

Marked For:	Hose Size Inches	O.D. Flange Inches	Length Neck Inches	Display Pkg.-5 pcs. 1 Pc. per card	OEM Bulk Pkg. 50 pcs.	Screw Size	Weight Ounces
*Gas	1 1/2	3 1/8	3 1/2	521 DPG CHR	521 G00 CHR	8	11
Diesel	1 1/2	3 1/8	3 1/2	521 DPD CHR	521 D00 CHR	8	11
Water	1 1/2	3 1/8	3 1/2	521 DPW CHR	521 W00 CHR	8	11

Spare Gas Cap with O-Ring and Retainer, Cat. No. 521 DPG 99A. Spare O-Rings Only (2 per bag), Cat. No. 513 008.
Spare Diesel Cap with O-Ring and Retainer, Cat. No. 521 DPD 99A. Spare Key, Cat. No. 1248 7-8 DP.
Spare Water Cap with O-Ring and Retainer, Cat. No. 521 DPW 99A.

*NOTE: These Items Meet the Requirements of U.S.C.G. Safety Standards, January 31, 1977, for Gasoline Fuel Systems, 33CFR183.

DECK PLATES FOR HOSE FIG. 1270

Chrome Plated Zinc

Black Plastic Cap

Complete with Fig. No. 1248 Key,
O-Ring and Integral Retainer on Cap.
Caps Have a Slot Between the Holes.



Fig. 1270

ORDERING INFORMATION

Marked For:	Hose Size Inches	O.D. Flange Inches	Length Neck Inches	Display Pkg.-5 pcs. 1 Pc. per card	OEM Bulk Pkg. 50 pcs.	Screw Size	Weight Ounces
*Gas	1 1/2	3 1/2	2 1/2	1270 DPG CHR	1270 G00 CHR	8	8
Diesel	1 1/2	3 1/2	2 1/2	1270 DPD CHR	1270 D00 CHR	8	8
Water	1 1/2	3 1/2	2 1/2	1270 DPW CHR	1270 W00 CHR	8	8

Spare Gas Cap with O-Ring and Retainer, Cat No. 1270 DPG 99A.
Spare Diesel Cap with O-Ring and Retainer, Cat No. 1270 DPD 99A.
Spare Water Cap with O-Ring and Retainer, Cat. No. 1270 DPW 99A.

Spare O-Rings (2 per bag), Cat. No. 513 008.
Spare Key, Cat. No. 1248 7-8 DP.



CHROMALEX® GAS FILL FIG. 1413

Chrome Plated Zinc
Black Plastic Cap and Base

Complete with Integral Cap Retainer/Gasket



Fig. 1413

ORDERING INFORMATION

For Hose Inches	Length Neck Inches	Dimensions Overall Inches	Std. Pkg.-1 pc. OEM Bulk Pkg.-50 pcs.	Screw Size	Weight Ounces
1 1/2	1 7/8	3 x 3	*1413 000 CHR	6	7

Spare Cap, Cat. No. 126 DP BLK.

*NOTE: These Items Meet the Requirements of U.S.C.G. Safety Standards, January 31, 1977, for Gasoline Fuel Systems, 33CFR183.

CHROMALEX® CAPS FIGS. 126 & 1324

Black Plastic
Complete with Gasket

Fig. 1324 has a Built-in Lock with Cover

Fig. 1324 is Supplied with 2 Keys
Both Caps Will Fit all PERKO CHROMALEX® Fills



Fig. 126



Fig. 1324

ORDERING INFORMATION

Cap Type	Display Pkg.-5 pcs.** 1 Pc. per card	Weight Ounces
Non-Locking	126 DP BLK	1/2
Locking	1324 DP BLK	3

**All Keyed Alike



CHROMALEX® FILLS FIGS. 1313, 1329 & 1399

Patent No. 3,828,714

Chrome Plated Zinc

Black Plastic Flange and Cap

Complete with Grounding Screw and Integral Cap Retainer/Gasket.
Locking Cap Has a Cover for the Key Hole.



Fig. 1399



Fig. 1313 — Gas
Fig. 1329 — Water



ORDERING INFORMATION

Marked For:	Hose Size Inches	O.D. Overall Inches	Length Neck Inches	Display Pkg.-5 pcs. 1 Pc. per card	OEM Bulk Pkg. 50 pcs.	Weight Ounces
*Gas	1 1/2	3 1/8	1 7/8	1313 DP CHR	1313 000 CHR	6
Water	1 1/2	3 1/8	1 7/8	1329 DP BLK	1329 000 BLK	6
*Gas w/Lock	1 1/2	3 1/8	1 7/8	1399 DP CHR	1399 000 CHR	6

Screw Size #6.

Spare Non-Locking Cap, Cat. No. 126 DP BLK.

Spare Locking Cap, Cat. No. 1324 DP BLK.

PLASTIC GAS FILL FIG. 1613

Black Plastic
Fiber Reinforced, U.V. Stabilized

Easy-Grip Cap

Complete With O-Ring and Integral Retainer.

No Deck Plate Key or Ground Wire Required.



Fig. 1613



ORDERING INFORMATION

For Hose Inches	O.D. Overall Inches	Length Neck Inches	Display Pkg.-5 pcs. 1 Pc. per card	OEM Bulk Pkg. 50 pcs.	Screw Size	Weight Ounces
1 1/2	3 1/16	2 7/16	*1613 DP BLK	*1613 000 BLK	8	4

Spare Cap with O-Ring and Retainer, Cat. No. 1613 000 99A. Spare O-Rings (2 per bag), Cat. No. 513 008.

PLASTIC WATER FILL FIG. 1629

Black Plastic
Fiber Reinforced, U.V. Stabilized

Easy-Grip Cap

Complete With O-Ring and Integral Retainer.

No Deck Plate Key or Ground Wire Required.



Fig. 1629



ORDERING INFORMATION

For Hose Inches	O.D. Overall Inches	Length Neck Inches	Display Pkg.-5 pcs. 1 Pc. per card	OEM Bulk Pkg. 50 pcs.	Screw Size	Weight Ounces
1 1/2	3 1/16	2 7/16	1629 DP BLK	1629 000 BLK	8	4

Spare Cap with O-Ring and Retainer, Cat. No. 1629 000 99A. Spare O-Rings (2 per bag), Cat. No. 513 008.

*NOTE: These Fills Meet the Requirements of U.S.C.G. Safety Standards, January 31, 1977, for Gasoline Fuel Systems, 33CFR183.

DECK PLATE KEY FIG. 1247

Chrome Plated Zinc

Compact Size with Hole for Key Chain.
Will Fit PERKO 1 1/4" and 1 1/2" Deck Plates
and Many Other "Slot" Type Opening Deck Plates.



Fig. 1247



ORDERING INFORMATION

C. to C. of Lugs	Length Spade Inches	Length Overall Inches	Display Pkg.-10 pcs. 1 Pc. per bag	Weight Ounces
1 1/8	1	1 3/4	1247 DP CHR	1

DECK PLATE KEY FIG. 1248

Plain Zinc

The Keys For 1" Thru 1 1/2" Inch Deck Plates Have a 1 Inch Spade on Handle That Allows Them to Fit Many Other "Slot" Type Opening Deck Plates.



Fig. 1248

ORDERING INFORMATION

For Deck Plate Size Inches	C. to C. of Lugs	Length Overall Inches	Display Pkg.-10 pcs. 1 Pc. per bag	Standard Pkg.-10 pcs.	Weight Ounces
1	5/8	3 3/8	-----	1248 006 ZNC	2
1 1/4 & 1 1/2	1 1/8	3 3/8	1248 7-8 DP	-----	2
2	1 11/16	4 3/8	-----	1248 009 ZNC	2 1/2
2 1/2	2	4 3/8	-----	*1248 010 ZNC	2 1/2

*Standard Pkg.-1 pc.



ADJUSTABLE DECK PLATE KEY FIG. 826

Chrome Plated Zinc

Hardened Steel Pins
Will Fit Sizes up to 8 Inch Diameter.



Fig. 826

ORDERING INFORMATION

Length Overall Inches	Display Pkg.-5 pcs. 1 Pc. per card	Weight Ounces
8 1/2	826 DP CHR	9 1/2



RETAINING CABLE FOR DECK PLATES FIG. 537

Stainless Steel Cable and Fittings with
1 3/8" Stainless Steel Ring and Self Tapping Screw

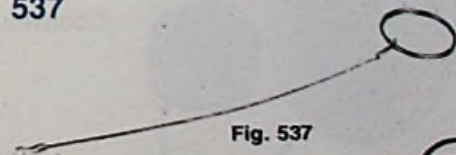

Fig. 537

ORDERING INFORMATION

Length Cable Inches	Display Pkg.-5 pcs. 1 Pc. per bag	OEM Bulk Pkg. 25 pcs.	Weight Ounces
7	537 DP	537	1/2



REGULAR DECK PLATE FIG. 526

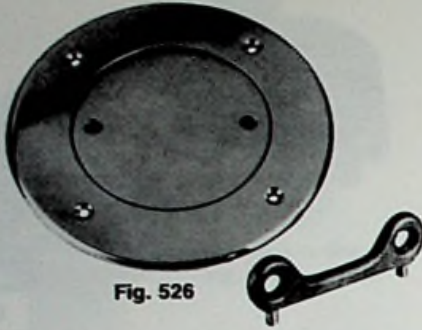

Fig. 526

**Cast Bronze
Plain or Chrome Plated**

Complete with Key

ORDERING INFORMATION

I.D. Opening Inches	O.D. Overall Inches	Plain	Chrome Plated	Screw Size	Weight Pounds
		Bronze Standard Pkg.-1 pc.	Bronze Standard Pkg.-1 pc.		
3	5 3/8	526 003 PLB	526 003 CHR	10	2
4	7 1/16	526 004 PLB	526 004 CHR	10	3 3/8
5	8 3/8	526 005 PLB	526 005 CHR	10	4 3/4
6	9 3/8	526 006 PLB	526 006 CHR	1/4	7 1/2
8	10 1/4	526 008 PLB	-----	1/4	8 3/4

SPARE PARTS ORDERING INFORMATION

I.D. Opening Inches	Plain	Chrome Plated	Spare Key Only
	Bronze Cap	Bronze Cap	
3	526 P03 99A	526 C03 99A	539 003 ZNC
4	526 P04 99A	526 C04 99A	539 004 PLB
5	526 P05 99A	526 C05 99A	539 005 PLB
6	526 P06 99A	526 C06 99A	539 006 PLB
8	526 P08 99A	-----	539 008 PLB

WATER INLET FITTING FIG. 499



Fig. 499

Chrome Plated Bronze

Standard Female Swivel Hose Connector.

Complete With Black Plastic Watertight Plug And Stainless Steel Bead Chain.
For Obtaining Water Under Pressure At Dockside.

ORDERING INFORMATION

Pipe Size Inches	O.D. Flange Inches	Display Pkg.-5 pcs. 1 Pc. per card	OEM BulkPkg. 10 pcs.	Screw Size	Weight Ounces
1/2	2 3/4	499 DP CHR	499 000 CHR	8	8

Spare Plug with Chain, Cat No. 499 DP 99A.



WATER OUTLET FITTING FIG. 504



Fig. 504

Chrome Plated Bronze

Standard Male Hose Connector.

Complete with a Watertight Black Plastic Cap and Stainless Steel Bead Chain.
For Use with On-board Washdown Systems.

ORDERING INFORMATION

Pipe Size Inches	O.D. Flange Inches	Display Pkg.-5 pcs. 1 Pc. per card	OEM BulkPkg. 10 pcs.	Screw Size	Weight Ounces
1/2	2 3/4	504 DP CHR	504 000 CHR	8	8

Spare Cap with Chain, Cat No. 504 DP 99A.



THRU-HULL SCUPPER FIG. 323

**Molded White Plastic
Soft Black Flapper Valve**

Complete With Nut And Mounting Hardware.
For Mounting Through The Transom.

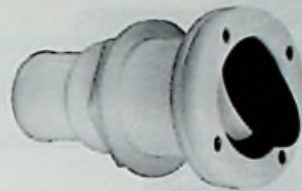
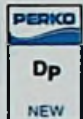

Fig. 323

Hose Size Inches	Maximum Hull Thickness Inches	O.D. Flange Inches	ORDERING INFORMATION		
			Display Pkg.-5 pcs. 1 Pc. per card	OEM Bulk Pkg. 50 pcs.	Weight Ounces
1 1/2	2 1/8	2 7/8	323 DP	323	5



SCUPPER VALVE ASSEMBLY FIG. 365

**Molded White Plastic
Soft Black Flapper Valve**

Without Thru-Hull and Mounting Hardware.
For Surface Mount Applications.



Fig. 365

ORDERING INFORMATION					
O.D. Flange Inches	Display Pkg.-5 pcs. 1 Pc. per card	OEM Bulk Pkg. 50 pcs.	Screw Size	Weight Ounces	
2 7/8	365 DP	365	6	1	



COCKPIT SCUPPER FIG. 285

**Molded White Plastic
Flush Mount**

For Use When Discharge is Above the Waterline.
Insert Prevents Passage of Large Objects
Without Restricting Water Flow.



Fig. 285

Hose Size Inches	Maximum Hull Thickness Inches	O.D. Flange Inches	I.D. Inches	ORDERING INFORMATION		
				Display Pkg.-5 pcs. 1 Pc. per card	OEM Bulk Pkg. 50 pcs.	Weight Ounces
1 1/2	1 3/4	2 3/4	1 1/2	285 DP	285	5

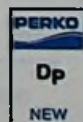

COCKPIT SCUPPER FIG. 142

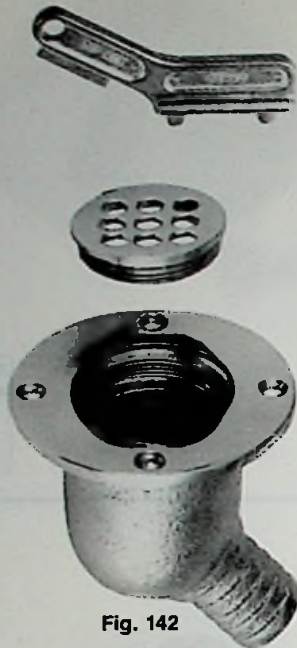

Fig. 142

Cast Bronze
Plain or Chrome Plated

Rubber Check Ball

Complete With Key
For Use When Discharge Is Below The Waterline.
Angle Of Outlet Is 45 Degrees.

ORDERING INFORMATION

Hose Size Inches	O.D. Grate Inches	O.D. Flange Inches	Plain Bronze Std. Pkg.-1 pc.	Chrome Plated Bronze Std. Pkg.-1 pc.	Weight Pounds
1	1 13/16	3 1/4	142 001 PLB	142 001 CHR	1 1/2
1 1/2	2 1/4	3 3/4	142 002 PLB	*142 002 CHR	2 5/8

Screw Size #8.

*O.E.M. Bulk Pkg.-10 pcs.

SPARE PARTS ORDERING INFORMATION

Hose Size Inches	Plain Bronze Grate	Chrome Plated Bronze Grate	Check Ball Only	Spare Key Only
1	142 P01 99A	142 C01 99A	142 001 99B	1248 7-8 DP
1 1/2	142 P02 99A	142 C02 99A	142 002 99B	1248 7-8 DP

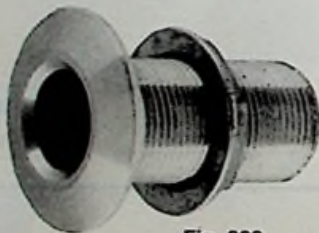
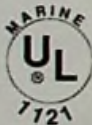

Fig. 322

THRU-HULL CONNECTION FIG. 322

Cast Bronze

Flange is Machined to Fit Hull and Grooved to Retain Bedding Compound.
Neck is Threaded to Approximately 3/8 Inch from Flange.



ORDERING INFORMATION

Pipe Size Inches	Maximum Hull Thickness Inches	O.D. Flange Inches	Display Pkg.-5 pcs. 1 Pc. per card	Standard Package-1 pc.	OEM Bulk Pkg 25 pcs.	Spare Flanged Nut Only	Weight Pounds
3/8	1 3/4	1 7/16	322 DP3 PLB	-----	322 003 PLB	75 003 PLB	3/8
1/2	1 3/8	1 1/2	322 DP4 PLB	-----	322 004 PLB	75 004 PLB	3/8
3/4	1 1/2	1 7/8	322 DP5 PLB	-----	322 005 PLB	75 005 PLB	1/2
1	1 7/8	2 3/16	322 DP6 PLB	-----	322 006 PLB	75 006 PLB	7/8
1 1/4	2	2 3/4	322 DP7 PLB	-----	322 007 PLB	75 007 PLB	1 1/8
1 1/2	2 1/4	3	322 DP8 PLB	-----	* 322 008 PLB	75 008 PLB	1 3/4
2	2 3/8	3 5/8	-----	322 009 PLB	-----	75 009 PLB	2
2 1/2	2 5/8	4 1/2	-----	322 010 PLB	-----	75 010 PLB	3 1/2
3	2 3/4	5	-----	322 011 PLB	-----	75 011 PLB	5

*O.E.M. Bulk Pkg.-10 pcs.



EXTRA LONG THRU-HULL CONNECTION FIG. 348

Cast Bronze

Similar to Fig. 322 Except Extended Neck is Threaded to Between 1 and 1 1/2 inches from Flange.

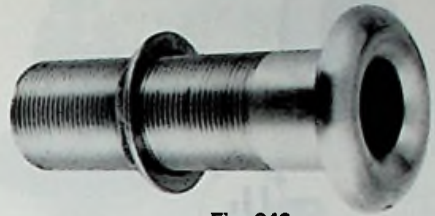

Fig. 348



ORDERING INFORMATION

Pipe Size Inches	Maximum Hull Thickness Inches	O.D. Flange Inches	Standard Package-1 pc.	OEM Bulk Pkg.	Spare Flanged Nut Only	Weight Pounds
3/4	5	1 7/8	348 005 PLB	25	75 005 PLB	7/8
1	4 7/8	2 1/4	348 006 PLB	10	75 006 PLB	1 1/4
1 1/4	4 5/8	2 3/4	348 007 PLB	10	75 007 PLB	2 1/2
1 1/2	4 5/8	3	348 008 PLB	10	75 008 PLB	2 1/4
2	4 1/2	3 5/8	348 009 PLB	---	75 009 PLB	3
2 1/2	4 1/4	4 5/16	348 010 PLB	---	75 010 PLB	4

THRU-HULL CONNECTION FIG. 350

Cast Bronze
Plain or Chrome Plated
For Use With Hose**

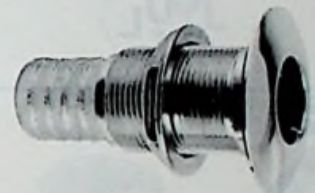

Fig. 350



Flange is Machined to Fit Hull and Grooved to Retain Bedding Compound.
Neck is Threaded to Approximately 3/8 Inch From Flange

ORDERING INFORMATION

Hose Size Inches	Maximum Hull Thickness Inches	O.D. Flange Inches	Plain Bronze Display Pkg. -5 pcs. 1 Pc. per card	Chrome Plated Bronze Display Pkg. -5 pcs. 1 Pc. per card	Plain Bronze OEM Bulk Pkg. 10 pcs.	Chrome Plated Bronze OEM Bulk Pkg. 10 pcs.	Weight Pounds
5/8	1 1/16	1 1/2	350 004 DPP	350 004 DPC	-----	*350 004 CHR	3/8
3/4	1 5/8	1 7/8	350 005 DPP	350 005 DPC	350 005 PLB	350 005 CHR	1/2
1	1 3/4	2 1/4	350 006 DPP	350 006 DPC	350 006 PLB	350 006 CHR	7/8
1 1/8	1 3/4	2 1/4	350 06A DPP	350 06A DPC	350 06A PLB	350 06A CHR	7/8
1 1/4	1 7/8	2 3/4	350 007 DPP	350 007 DPC	350 007 PLB	-----	1 3/8
1 1/2	1 7/8	3 1/8	350 008 DPP	350 008 DPC	350 008 PLB	350 008 CHR	1 1/2

*O.E.M. Bulk Pkg. -25 pcs.

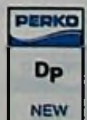

**NOTE: Thru-Hull Connections For Use With Hose Are Not Recommended For Use Below The Waterline Per A.B.Y.C. "Safety Standards For Small Craft" Section H-27.

THRU-HULL CONNECTION FIG. 311

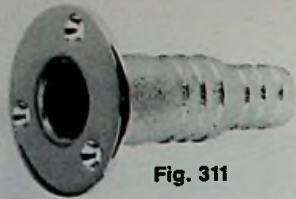
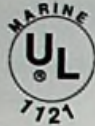

Fig. 311



Chrome Plated Bronze

For Use With Hose**

ORDERING INFORMATION

Hose Size Inches	Length Overall Inches	I.D. Inches	O.D. Flange Inches	Standard Pkg.-1 pc.	Screw Size	Weight Ounces
3/4 & 1	3 1/8	9/16	2	311 000 CHR	8	8

THRU-HULL CONNECTION FIG. 301



Fig. 301

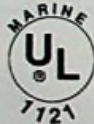

Molded White Plastic

Narrow Flange

For Use With Hose**

ORDERING INFORMATION

Hose Size Inches	Maximum Hull Thickness Inches	O.D. Flange Inches	Display Pkg.-10 pcs. 1 Pc. per card	OEM Bulk Pkg. 100 pcs.	Weight Ounces
1/2	1 1/4	1 1/4	301 DP4	301 004	1
5/8	1 1/4	1 1/4	301 DP4A	301 04A	1
3/4	1 7/16	1 1/2	301 DP5	301 005	1 1/2
1	1 1/2	1 7/8	*301 DP6	**301 006	2
1 1/8	1 1/2	1 7/8	*301 DP6A	**301 06A	2
1 1/2	1 7/8	2 1/2	*301 DP8	**301 008	4

*Display Pkg.-5 pcs.

**OEM Bulk Pkg.-50 pcs.

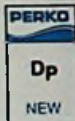

THRU-HULL CONNECTION FIG. 328

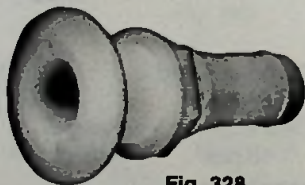
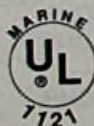

Fig. 328



Molded White Plastic

Broad Flange

For Use With Hose**

ORDERING INFORMATION

Hose Size Inches	Maximum Hull Thickness Inches	O.D. Flange Inches	Display Pkg.-10 pcs. 1 Pc. per card	OEM Bulk Pkg. 100 pcs.	Weight Ounces
1/2	1 1/4	1 1/2	328 DP4	328 004	1
5/8	1 1/4	1 1/2	328 DP4A	328 004A	1
3/4	1 7/16	2 1/16	328 DP5	328 005	1 1/2
1	1 1/2	2 1/4	*328 DP6	**328 006	2
1 1/8	1 1/2	2 1/4	*328 DP6A	**328 006A	2
1 1/2	1 7/8	3	*328 DP8	**328 008	4

*Display Pkg.-5 pcs.

**OEM Bulk Pkg.-50 pcs.



**NOTE: Thru-Hull Connections For Use With Hose Are Not Recommended For Use Below The Waterline Per A.B.Y.C. "Safety Standards For Small Craft" Section H-27.

SEACOCKS FIGS. 834 & 835

Ball Valve Design

Cast Bronze

Complete with Thru-Hull, Hose Adapter, Drain Plug, Four Pre-Drilled Mounting Holes and Bonding Screw.

Fig. 834 — With 90° Curved Hose Adapter.

Fig. 835 — With Straight Hose Adapter.

PERKO Seacocks Incorporate a Plastic Ball and Seat Assuring a Tight Seal and Ease of Operation. Drain Plugs for Winterizing. Handles Easily Removed.



Fig. 834



Fig. 835



ORDERING INFORMATION

Hose Size Inches	Pipe Size Inches	Fig. 834	Fig. 835	OEM		Weight Pounds
		Standard Package-1 pc.	Standard Package-1 pc.	Bulk Pkg.	Bolt Size	
3/4	3/4	834 005 PLB	835 005 PLB	5	5/16	3 1/8
1	1	834 006 PLB	835 006 PLB	--	3/8	5 1/8
1 1/4	1 1/4	834 007 PLB	835 007 PLB	5	3/8	6 3/4
1 1/2	1 1/2	834 008 PLB	835 008 PLB	5	3/8	10
2	2	834 009 PLB	835 009 PLB	--	3/8	22
2 1/2	2 1/2	834 010 PLB	835 010 PLB	--	1/2	25
3	3	834 011 PLB	835 011 PLB	--	1/2	32

SEACOCK BODY FIG. 805

Ball Valve Design

Cast Bronze

These Valve Bodies are Offered to Meet the Needs of Applications that Require Extra Long, Scoop or Flush Type Thru-Hulls.

ORDERING INFORMATION

Pipe Size Inches	Standard	OEM	
	Package-1 pc.	Bulk Pkg.	Weight Pounds
3/4	805 005 PLB	5	2 1/2
1	805 006 PLB	5	4
1 1/4	805 007 PLB	5	5 1/8
1 1/2	805 008 PLB	5	6 3/8
2	805 009 PLB	--	11 3/8
2 1/2	805 010 PLB	--	19
3	805 011 PLB	--	24



Fig. 805

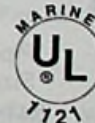

SPARE PARTS ORDERING INFORMATION

The Repair Kits Listed Below Consist of: 1 Ball, 2 Ball Seats and 2 O-Rings for the Valve Stem.

Pipe Size Inches	Repair Kit	Pipe Size Inches	Repair Kit	Pipe Size Inches	Repair Kit
3/4	805 005 99B	1 1/2	805 008 99B	3	805 011 99B
1	805 006 99B	2	805 009 99B		
1 1/4	805 007 99B	2 1/2	805 010 99B		

INLINE VALVE FIG. 825



Fig. 825

Cast Bronze

Complete with Drain Plug and Bonding Screw.
Ball Valve for Smooth Operation.

ORDERING INFORMATION

Pipe Size Inches	Standard Package-1 pc.	OEM Bulk Pkg.	Weight Pounds
1/2	825 004 PLB	10	1
3/4	825 005 PLB	10	1 1/4
1	825 006 PLB	10	1 3/4
1 1/4	825 007 PLB	10	2 3/4
1 1/2	825 008 PLB	5	4 1/4

PIPE TO HOSE ADAPTER FIG. 63



Fig. 63

Cast Bronze
Curved 90 Degrees

ORDERING INFORMATION

Pipe Size Inches	Hose Size Inches	Length Overall Inches	Standard Package-1 pc.	OEM Bulk Pkg.	Weight Pounds
3/4	3/4	4 1/2	63 005 PLB	25	1/2
1	1	4 3/4	63 006 PLB	25	3/4
1 1/4	1 1/4	5 1/2	63 007 PLB	25	1
1 1/2	1 1/2	6	63 008 PLB	10	1 1/4
2	2	7	63 009 PLB	---	2 1/2
2 1/2	2 1/2	8 1/2	63 010 PLB	---	3 7/8
3	3	10	63 011 PLB	---	6 3/8

NOTE: The Above Item Meets the Requirements of U.S.C.G. Safety Standards, January 31, 1977 for Gasoline Fuel Systems, 33CFR183.

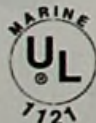

Fig. 76

PIPE TO HOSE ADAPTER FIG. 76

Cast Bronze

ORDERING INFORMATION



Pipe Size Inches	Hose Size Inches	Length Overall Inches	Display Pkg.-5 pcs. 1 Pc. per card	Standard Package-1 pc.	OEM Bulk Pkg 25 pcs.	Weight Pounds
1/2	5/8	1 5/8	76 DP4 PLB	-----	76 004 PLB	1/8
3/4	3/4	1 3/4	76 DP5 PLB	-----	76 005 PLB	1/4
1	1	1 3/4	76 DP6 PLB	-----	76 006 PLB	3/8
1 1/4	1 1/4	2	76 DP7 PLB	-----	76 007 PLB	1/2
1 1/2	1 1/2	2 1/4	76 DP8 PLB	-----	76 008 PLB	3/4
2	2	2 5/8	-----	76 009 PLB	76 009 PLB	1
2 1/2	2 1/2	4	-----	76 010 PLB	-----	2 1/8
3	3	5 1/8	-----	76 011 PLB	-----	3

NOTE: The Above Item Meets the Requirements of U.S.C.G. Safety Standards, January 31, 1977 for Gasoline Fuel Systems, 33CFR183.

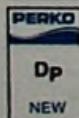

INTAKE STRAINER FIG. 65

Cast Bronze



Fig. 65



ORDERING INFORMATION

Pipe Size Inches	Maximum Hull Thickness Inches	Dimensions Strainer Inches	Display Pkg.-5 pcs. 1 Pc. per card	Standard Package-1 pc.	OEM Bulk Pkg. 10 pcs.	Weight Pounds
1/2	2 1/4	3 x 4	-----	65 004 PLB	65 004 PLB	3/4
3/4	2 3/16	3 x 4	65 DP5 PLB	-----	65 005 PLB	1
1	2 1/2	3 x 4	-----	65 006 PLB	65 006 PLB	1 1/4
1 1/4	3	3 1/4 x 4 1/4	-----	65 007 PLB	65 007 PLB	2

Screw Size # 8.

SCOOP STRAINER FIG. 66

Cast Bronze



Fig. 66

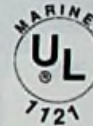

ORDERING INFORMATION

For Thru-Hull Sizes Inches	Dimensions Overall Inches	Standard Package-5 pcs.	Weight Pounds
3/8 & 1/2	3 1/2 x 2 1/2	66 001 PLB	1 3/4
3/4 & 1	5 x 3 1/4	66 002 PLB	4 1/2
1 1/4 & 1 1/2	6 1/4 x 4 1/4	66 003 PLB	6 3/8
2	8 x 5 1/8	66 004 PLB	10

Screw Size # 8.

ROUND STRAINER FIG. 86

Cast Bronze



Fig. 86



ORDERING INFORMATION

For Thru-Hull Sizes Inches	O.D. Inches	I.D. Inches	Display Pkg.-5 pcs. 1 Pc. per card	Standard Package-5 pcs.	OEM Bulk Pkg. 25 pcs.	Screw Size	Weight Pounds
3/8 & 1/2	2 1/2	1 5/8	-----	86 001 PLB	-----	8	3/16
3/4	3	2	86 DP2 PLB	-----	86 002 PLB	8	1/4
1	3 1/2	2 3/8	-----	86 003 PLB	86 003 PLB	8	3/8
1 1/4 & 1 1/2	4	3	-----	86 004 PLB	-----	8	1/2
2	5	3 3/4	-----	86 005 PLB	86 005 PLB	8	3/4
2 1/2	6	4 1/2	-----	*86 006 PLB	**86 006 PLB	10	1 1/4
3	8	6 1/4	-----	*86 007 PLB	-----	10	2 1/2

*Standard Package-1 pc.

**OEM Bulk Package-10 pcs.



PUMP STRAINER FIG. 709



Fig. 709

Cast Bronze

ORDERING INFORMATION

Hose Size Inches	Length Overall Inches	Width Overall Inches	Display Pkg.-5 pcs. 1 Pc. per card	OEM Bulk Pkg. 25 pcs.	Weight Ounces
5/8	3 5/8	1 3/4	709 DP PLB	709 000 PLB	6



Fig. 704

PUMP STRAINERS FIGS. 704 & 705

Cast Bronze



Fig. 705

ORDERING INFORMATION

Hose Size Inches	Length Overall Inches	Width Overall Inches	Standard Package-1 pc.	OEM Bulk Package	Weight Pounds
1 1/4	6 3/8	2 3/4	704 000 PLB	10	2
1 1/4	4 1/2	2 3/4	705 000 PLB	---	1 1/2



Fig. 721

PUMP STRAINERS FIGS. 721 & 722

Cast Bronze



Fig. 722

ORDERING INFORMATION

Pipe Size Inches	Length Overall Inches	Width Overall Inches	Standard Package-1 pc.	OEM Bulk Package	Weight Pounds
1 1/4	4 3/4	2 3/4	721 000 PLB	---	1 3/4
1 1/4	4 1/2	2 3/4	722 000 PLB	10	1 3/8

FUEL FILTER AND SEPARATOR FIG. 299

Cast Bronze

Microporous Filter Element

Complete with Adjustable Mounting Bracket, Drain Plug and O-Ring.
These Units Separate Water from Gasoline or Diesel Fuel and
Filter out Particles of 40 Microns or Larger in Size.

ORDERING INFORMATION

Pipe Size Inches	Height Overall Inches	O.D. Overall Inches	Standard Package-1 pc.	Dimensions Element Inches	Screw Size	Weight Pounds
3/8	5 1/2	2 3/8	299 001 PLB	1 3/4 x 1 3/4	8	3 3/4
1/2	6 1/4	3 1/8	299 002 PLB	2 1/4 x 2	10	5 1/2

Spare Element and O-Ring for 3/8", Cat No. 324 001 ELM.
Spare Element and O-Ring for 1/2", Cat No. 324 002 ELM.

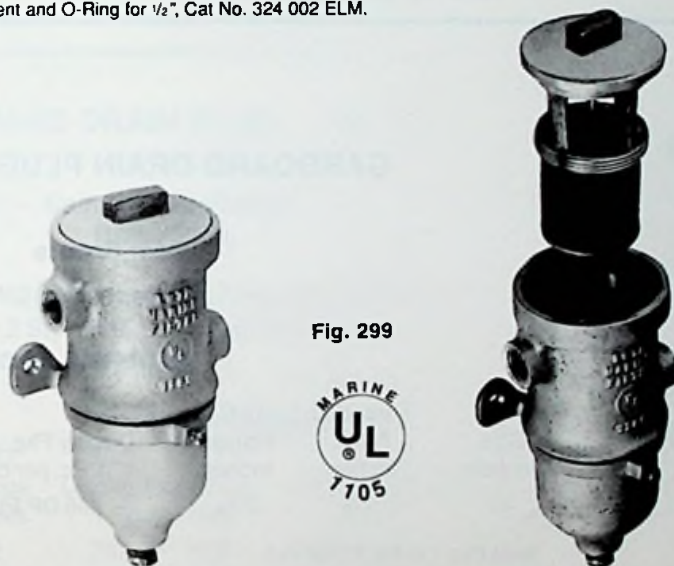

Fig. 299



NOTE: This Item Meets the Requirements of U.S.C.G. Safety Standards, January 31, 1977, for Gasoline Fuel Systems, 33CFR183.

TRANSOM DRAIN PLUG FIG. 414

Brass
Black Plastic Handle
Expandable Plug

ORDERING INFORMATION

I.D. Tube Inches	Length Tube Inches	Length Overall Inches	Display Pkg.-10 pcs. 1 Pc. per card	Weight Ounces
1	2	2 1/2	414 DP1 PLB	3 1/2



Fig. 414

Spare Plug, Cat No. 414 DP 99A.
Spare Tube, Cat No. 414 001 99B.





Fig. 263

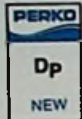

GARBOARD DRAIN PLUG FIG. 263

Cast Bronze

ORDERING INFORMATION

Pipe Size Inches	Length Threaded Neck Inches	O.D. Flange Inches	Display Pkg.-5 pcs. 1 Pc. per card	Screw Size	Weight Ounces
3/4	5/8	2 3/8	263 DP PLB	8	12

Spare Plug, Cat. No. 370 DP PLB.



Fig. 266

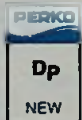

GARBOARD DRAIN PLUG FIG. 266

Cast Bronze

ORDERING INFORMATION

Pipe Size Inches	Length Threaded Neck Inches	O.D. Flange Inches	Display Pkg.-5 pcs. 1 Pc. per card	Screw Size	Weight Ounces
3/4	5/8	2 3/8	266 DP PLB	8	12

Spare Plug, Cat. No. 370 DP PLB.



Fig. 363

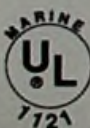
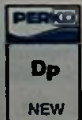

GARBOARD DRAIN PLUG FIG. 363

Cast Bronze

ORDERING INFORMATION

Pipe Size Inches	Maximum Hull Thickness Inches	Length Threaded Neck Inches	O.D. Flange Inches	Display Pkg.-5 pcs. 1 Pc. per card	OEM Bulk Pkg. 25 pcs.	Weight Ounces
3/4	3/4	1 1/4	2 3/8	363 DP PLB	363 000 PLB	15

Spare Plug, Cat. No. 370 DP PLB.

GARBOARD DRAIN PLUG FIG. 714

**Cast Bronze Flange
Brass Plug**

No.2 Style has Stainless Steel Pin.



Fig. 714 No. 1

Fig. 714 No. 2

ORDERING INFORMATION

Pipe Size Inches	O.D. Flange Inches	Display Pkg.-5 pcs. 1 Pc. per bag	OEM Bulk Pkg. 50 pcs.	Screw Size	Weight Ounces
1/2	2	714 DP1 PLB	714 001 PLB	8	4
1/2	2	714 DP2 PLB	714 002 PLB	8	4

Spare No. 1 Plug, Cat. No. 742 DP1.

Spare No. 2 Plug, Cat. No. 742 DP2.



GARBOARD DRAIN PLUG FIG. 737

**Cast Bronze Flange
Brass Plug**

Complete With Brass Backing Plate and Fasteners.
No.2 Style has Stainless Steel Pin.



Fig. 737 No. 1

Fig. 737 No. 2

ORDERING INFORMATION

Pipe Size Inches	Maximum Hull Thickness Inches	O.D. Flange Inches	Display Pkg.-5 pcs. 1 Pc. per bag	OEM Bulk Pkg. 50 pcs.	Screw Size	Weight Ounces
1/2	7/16	2	737 DP1 PLB	737 001 PLB	8-32	5
1/2	7/16	2	737 DP2 PLB	737 002 PLB	8-32	5

Spare No. 1 Plug, Cat. No. 742 DP1.

Spare No. 2 Plug, Cat. No. 742 DP2.

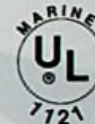

GARBOARD DRAIN PLUG FIG. 124

**Cast Bronze Flange
Brass Plug**

Complete with Zinc Plated Steel Wrench.



Fig. 124

ORDERING INFORMATION

Pipe Size Inches	Length Threaded Neck Inches	O.D. Flange Inches	Standard Package-5 pcs.	Screw Size	Weight Pounds
1	1	3 1/8	124 000 PLB	10	1 1/4

Spare Wrench, Cat No. 124 000 99A.

Spare Plug, Cat No. 124 000 99B.



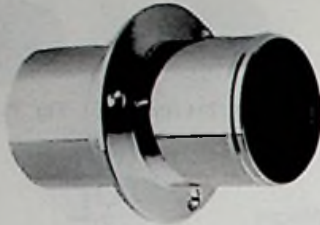

Fig. 357

RIGGING TUBE FIG. 357

Chrome Plated Brass and Bronze

For Use With 2 Inch I.D. Hose To Pass Wiring Harnesses and Control Cables Through Transoms and Motorwell Bulkheads.

Mounts In 2 1/8 Inch Diameter Hole.

ORDERING INFORMATION

O.D. Tube Inches	Length Overall Inches	O.D. Flange Inches	Standard Pkg-1 pcs. OEM Bulk Pkg.-25 pcs.	Screw Size	Weight Ounces
2	4 1/8	3 1/8	357 001 CHR	8	12



Fig. 307

CAULKING IRON FIG. 307

Malleable Iron

ORDERING INFORMATION

Thickness Blade Inches	Width Blade Inches	Length Overall Inches	Standard Package-10 pcs.	Weight Ounces
1/32	2	5	307 000	5
1/16	2 1/2	5 5/8	307 00A	6 1/2
1/8	2 1/4	5 7/8	307 001	7

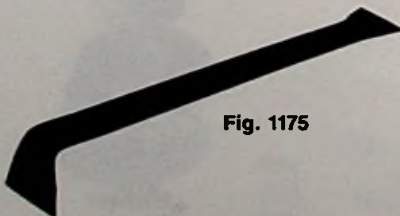

Fig. 1175

DOUBLE END SCRAPER FIG. 1175

Heat Treated Steel

ORDERING INFORMATION

Length Overall Inches	Width Blade Inches	Width Shank Inches	Thickness Shank Inches	Standard Package-5 pcs.	Weight Pounds
15	1 3/4	1	1/4	1175	1

CLOSED BASE CLEAT FIG. 566

Chrome Plated Zinc



Fig. 566

ORDERING INFORMATION

Length Overall Inches	Dimensions Base Inches	Max. Rope Size Inches	Display Pkg.-5 cds. 2 Pcs. per card	Screw Size	Weight Ounces
2	2 ³ / ₁₆ x 1 ¹ / ₈	⁵ / ₁₆	566 DP2 CHR	6	1 ¹ / ₂
3	3 ¹ / ₈ x 1 ¹ / ₂	³ / ₈	566 DP3 CHR	8	4 ¹ / ₂
4 ¹ / ₂	4 ⁷ / ₁₆ x 1 ⁷ / ₈	¹ / ₂	566 DP4 CHR	10	8 ¹ / ₂
6	5 ¹ / ₂ x 2	³ / ₄	*566 DP6 CHR	12	13 ¹ / ₂

* Display Pkg. 5 pcs., 1 Pc. per card



CLOSED BASE CLEAT FIG. 1251

Chrome Plated Zinc



Fig. 1251

ORDERING INFORMATION

Length Overall Inches	Dimensions Base Inches	Max. Rope Size Inches	Display Pkg.-10 cds. 1 Pc. per card	Screw Size	Weight Ounces
3	1 ³ / ₈ x 1 ³ / ₁₆	³ / ₈	1251 DP3 CHR	8	2 ¹ / ₃
4 ¹ / ₂	1 ¹ / ₂ x 1 ¹ / ₄	¹ / ₂	1251 DP4 CHR	8	6



OPEN BASE CLEAT FIG. 1252

Chrome Plated Zinc



Fig. 1252

ORDERING INFORMATION

Length Overall Inches	Dimensions Base Inches	Max. Rope Size Inches	Display Pkg.- 5 cds. 2 Pcs. per card	OEM Bulk Pkg. 50 pcs.	Screw Size	Weight Ounces
6 ¹ / ₂	3 x 1 ¹ / ₈	³ / ₄	1252 DP CHR	1252 000 CHR	¹ / ₄	7





Fig. 572

OPEN BASE CLEAT FIG. 572

Chrome Plated Bronze

ORDERING INFORMATION

Length Overall Inches	Dimensions Base Inches	Max. Rope Size Inches	Display Pkg.-5 pcs. 1 Pc. per card	Standard Package-10 pcs.	OEM Bulk Pkg. 10 pcs.	Screw Size	Weight Pounds
*4 1/2	2 5/16 x 1 11/16	3/8	-----	572 04A CHR	-----	10	1/2
*5 1/2	2 13/16 x 1 3/4	7/16	-----	572 05A CHR	-----	10	5/8
*6 1/2	3 5/16 x 1 7/8	1/2	572 DP6 CHR	-----	572 06A CHR	12	3/4
8	4 x 2 1/4	3/4	572 DP8 CHR	-----	572 008 CHR	1/4	1 1/4
10	5 1/16 x 2 13/16	7/8	-----	**572 010 CHR	-----	5/16	1 3/4
12	6 1/16 x 2 7/8	1	-----	**572 012 CHR	-----	5/16	2 1/2

*These Sizes Are Solid, Balance of Sizes Are Hollow.

**Standard Package, 1 pc.



Fig. 1188

OPEN BASE CLEAT FIG. 1188

Chrome Plated Zinc

ORDERING INFORMATION

Length Overall Inches	Dimensions Base Inches	Max. Rope Size Inches	Display Pkg.-5 pcs. 1 Pc. per card	Catalog Number	Std. Pkg.	OEM Bulk Pkg.	Screw Size	Weight Pounds
4	2 1/8 x 1 1/2	5/16	*1188 DP4 CHR	1188 004 CHR	--	50	10	1/4
6	3 x 1 3/4	7/16	1188 DP6 CHR	1188 006 CHR	--	50	10	1/2
8	4 x 2 1/8	5/8	1188 DP8 CHR	1188 008 CHR	--	25	1/4	3/4
10	5 x 2 3/8	7/8	-----	1188 010 CHR	1	10	1/4	1 1/2
12	6 x 3	1	-----	1188 012 CHR	1	10	5/16	2 1/2

*Display Package, 5 cards., 2 Pcs. per card.



Fig. 1210

OPEN BASE CLEAT FIG. 1210

Chrome Plated Zinc
Zinc Plated Steel Studs

ORDERING INFORMATION

Length Overall Inches	Dimensions Base Inches	Max. Rope Size Inches	Catalog Number	Std. Pkg.	OEM Bulk Pkg.	Stud Size	Weight Ounces
4	2 1/8 x 1 1/2	5/16	1210 004 CHR	10	50	12-24 x 1 1/4	5 1/2
6	3 x 1 3/4	7/16	1210 006 CHR	10	30	1/4-20 x 2	8
8	4 x 2 1/8	5/8	1210 008 CHR	5	30	1/4-20 x 2	12 1/2

OPEN BASE CLEAT FIG. 530

Plain Aluminum



Fig. 530

ORDERING INFORMATION

Length Overall Inches	Dimensions Base Inches	Max. Rope Size Inches	Standard Package-1 pc.	Screw Size	Weight Pounds
8	4 x 2 1/4	3/4	530 008 ALU	1/2	1 1/8
10	4 1/2 x 3	7/8	530 010 ALU	1/2	1 3/4
12	6 1/2 x 2 7/8	1	530 012 ALU	5/8	3 1/2
15	7 x 3 1/4	1 1/2	530 015 ALU	3/4	4 7/8

CLEAT FIG. 545

Plain Aluminum



Fig. 545

ORDERING INFORMATION

Length Overall Inches	Dimensions Base Inches	Max. Rope Size Inches	Display Pkg.-5 cds. 2 Pcs. per card	Standard Package-5 pcs.	Screw Size	Weight Ounces
3	1 1/2 x 5/8	1/4	545 DP3 ALU	-----	8	1 1/2
4	1 5/8 x 3/4	5/16	545 DP4 ALU	-----	10	2
5	2 x 7/8	3/8	545 DP5 ALU	-----	1/4	3
6	2 1/4 x 7/8	7/16	**545 DP6 ALU	-----	1/4	4
*8	2 5/8 x 1 7/8	5/8	**548 DP8 ALU	-----	1/4	5
*10	3 5/8 x 1 1/2	3/4	-----	545 010 ALU	5/16	9
*12	4 x 1 1/2	7/8	-----	545 012 ALU	5/16	14

*These Sizes are Open Base, Balance of Sizes are Closed Base.

**Display Package, 10 pcs., 1 Pc. per card.



CLEAT FIG. 544

Cast Bronze
Polished or Chrome Plated

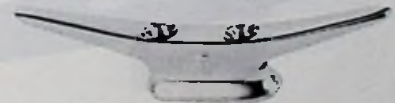

Fig. 544

ORDERING INFORMATION

Length Overall Inches	Dimensions Base Inches	Max. Rope Size Inches	Chrome Plated Bronze Display Pkg.	Display Pkg.-5 cds. Pcs. per card	Polished Bronze Standard Pkg.	Chrome Plated Bronze Standard Pkg.	Std. Pkg.	Screw Size
3	1 1/2 x 5/8	1/4	544 DP3 CHR	2	544 003 POL	-----	10	8
4	1 5/8 x 3/4	5/16	544 DP4 CHR	1	544 004 POL	-----	5	10
5	2 x 7/8	3/8	-----	--	544 005 POL	544 005 CHR	5	1/4
6	2 1/4 x 7/8	1/2	-----	--	544 006 POL	544 006 CHR	5	1/4
*8	2 5/8 x 1 1/2	3/4	-----	--	544 008 POL	**544 008 CHR	1	1/4

*This Size is Open Base, Balance of Sizes are Closed Base.

**O.E.M. Bulk Package, 10 pcs.



CHROMALEX® CLEATS

PATENT NO. 3,828,714

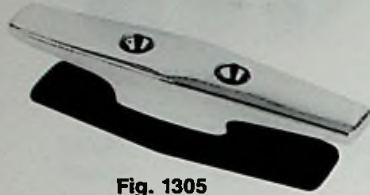

Fig. 1305

CLOSED BASE CLEAT FIG. 1305

Chrome Plated Zinc
Black Plastic Base

ORDERING INFORMATION

Length Overall Inches	Max. Rope Size Inches	Display Pkg.	Display Pkg.-5 cds. Pcs. per card	OEM Bulk Pkg. 50 pcs.	Screw Size	Weight Ounces
4 1/2	3/8	1305 DP1 CHR	2	1305 001 CHR	10	5
6	1/2	1305 DP2 CHR	1	1305 002 CHR	1/4	10



Fig. 1405

CLOSED BASE CLEAT FIG. 1405

Chrome Plated Zinc
Black Plastic Base and Insert

ORDERING INFORMATION

Length Overall Inches	Max. Rope Size Inches	Display Pkg.	Display Pkg.- 5 cds. Pcs. per card	OEM Bulk Pkg. 50 pcs.	Screw Size	Weight Ounces
4 1/2	3/8	1405 DP1 CHR	2	1405 001 CHR	10	5
6	1/2	1405 DP2 CHR	1	1405 002 CHR	1/4	10



CHROMALEX® CLEATS

PATENT NO. 3,828,714

CLOSED BASE CLEAT FIG. 1315

Chrome Plated Zinc
Black Plastic Base
Zinc Plated Steel Studs, Nuts and Washers



Fig. 1315

ORDERING INFORMATION

Length Overall Inches	Max. Rope Size Inches	Catalog Number	Std. Pkg.	OEM Bulk Pkg.	Stud Size	Weight Ounces
4 1/2	3/8	1315 001 CHR	10	50	12-24 x 1 1/2	6 1/2
6	1/2	1315 002 CHR	5	40	1/4 x 1 1/2	12

CLOSED BASE CLEAT FIG. 1415

Chrome Plated Zinc
Black Plastic Base and Insert
Zinc Plated Steel Studs, Nuts and Washers



Fig. 1415

ORDERING INFORMATION

Length Overall Inches	Max. Rope Size Inches	Catalog Number	Std. Pkg.	OEM Bulk Pkg.	Stud Size	Weight Ounces
4 1/2	3/8	1415 001 CHR	10	50	12-24 x 1 1/2	6 1/2
6	1/2	1415 002 CHR	5	40	1/4 x 1 1/2	12

CHROMALEX® CLEATS

PATENT NO. 3,828,714

OPEN BASE CLEAT FIG. 1306



Fig. 1306

Chrome Plated Zinc
Black Plastic Base

ORDERING INFORMATION



Length Overall Inches	Max Rope Size Inches	Display Pkg.	Display Pkg.-5 cds. Pcs. per card	OEM Bulk Pkg. 50 pcs.	Screw Size	Weight Ounces
4 1/2	3/8	1306 DP1 CHR	2	1306 001 CHR	10	4
6	1/2	1306 DP2 CHR	1	1306 002 CHR	1/4	8 1/2

OPEN BASE CLEAT FIG. 1406

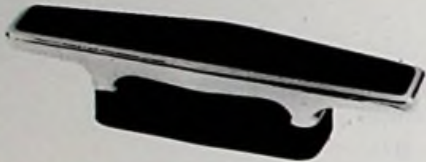

Fig. 1406

Chrome Plated Zinc
Black Plastic Base and Insert

ORDERING INFORMATION



Length Overall Inches	Max. Rope Size Inches	Display Pkg.	Display Pkg.-5 cds. Pcs. per card	OEM Bulk Pkg. 50 pcs.	Screw Size	Weight Ounces
4 1/2	3/8	1406 DP1 CHR	2	1406 001 CHR	10	4
6	1/2	1406 DP2 CHR	1	1406 002 CHR	1/4	8 1/2
8	3/4	-----	--	1406 003 CHR	1/4	11



OPEN BASE CLEAT FIG. 1326



Fig. 1326

Chrome Plated Zinc
Black Plastic Base

ORDERING INFORMATION



Length Overall Inches	Dimensions Base Inches	Max. Rope Size Inches	Display Pkg.-5 pcs. 1 Pc. per card	OEM Bulk Pkg. 50 pcs.	Screw Size	Weight Ounces
5 3/4	3 5/8 x 7/8	1/2	1326 DP2 CHR	1326 002 CHR	1/4	9

OPEN BASE CLEAT FIG. 573



Fig. 573

Chrome Plated Bronze
Black Plastic Base

ORDERING INFORMATION



Length Overall Inches	Dimensions Base Inches	Max. Rope Size Inches	Display Pkg.-5 pcs. 1 Pc. per card	OEM Bulk Pkg. 25 pcs.	Screw Size	Weight Ounces
6	3 5/8 x 7/8	1/2	573 DP6 CHR	573 006 CHR	1/4	9

CHROMALEX® CLEATS

PATENT NO. 3,828,714

OPEN BASE CLEAT FIG. 1316

Chrome Plated Zinc
Black Plastic Base
Zinc Plated Steel Studs, Nuts and Washers



Fig. 1316

ORDERING INFORMATION

Length Overall Inches	Max. Rope Size Inches	Catalog Number	Std. Pkg.	OEM Bulk Pkg.	Stud Size	Weight Ounces
4 1/2	3/8	1316 001 CHR	10	50	12-24 x 1 1/2	5
6	1/2	1316 002 CHR	5	40	1/4 x 1 1/2	10 1/2

OPEN BASE CLEAT FIG. 1416

Chrome Plated Zinc
Black Plastic Base and Insert
Zinc Plated Steel Studs, Nuts and Washers



Fig. 1416

ORDERING INFORMATION

Length Overall Inches	Max. Rope Size Inches	Catalog Number	Std. Pkg.	OEM Bulk Pkg.	Stud Size	Weight Ounces
4 1/2	3/8	1416 001 CHR	10	50	12-24 x 1 1/2	5
6	1/2	1416 002 CHR	5	40	1/4 x 1 1/2	10 1/2
8	3/4	1416 003 CHR	1	30	1/4 x 1 1/2	13

MOORING BITS FIGS. 608 & 1219

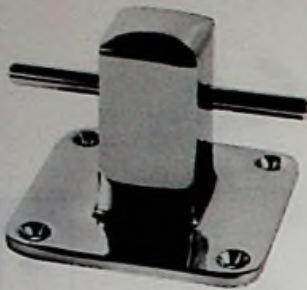

Fig. 608
Chrome Plated Bronze

Fig. 1219
Chrome Plated Zinc

Fig. 608 — Chrome Plated Bronze
Fig. 1219 — Chrome Plated Zinc

Hollow

ORDERING INFORMATION

Dimensions Base Inches	Height Inches	Fig. 608 Standard Pkg.- 1 pc.	Fig. 1219 Standard Pkg.-1 pc.	Bolt Size	Weight Pounds
3 x 3	2 1/2	608 001 CHR	-----	10	7/8
4 1/4 x 4 1/4	3 1/2	608 002 CHR	-----	1/4	1 7/8
5 x 5	4 3/4	608 02A CHR	1219 02A CHR	3/8	3 1/2
6 x 6	5	608 003 CHR	-----	3/8	4 1/2

COMBINATION BITT AND ROPE DECK PIPES FIGS. 431 & 1237

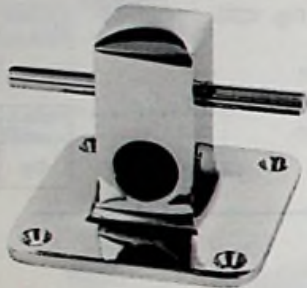

Fig. 431
Chrome Plated Bronze

Fig. 1237
Chrome Plated Zinc

Fig. 431 — Chrome Plated Bronze
Fig. 1237 — Chrome Plated Zinc

Hollow

ORDERING INFORMATION

Dimensions Base Inches	Opening For Rope Size Inches	Height Inches	Fig. 431 Standard Pkg.- 1 pc.	Fig. 1237 Standard Pkg.-1 pc.	Bolt Size	Weight Pounds
4 1/4 x 4 1/4	3/4	3 1/2	431 002 CHR	-----	1/4	1 3/4
5 x 5	1	4 3/4	431 02A CHR	1237 02A CHR	3/8	3 1/4
6 x 6	1	5	431 003 CHR	-----	3/8	4

HAWSE HOLE PLATE FIG. 1250

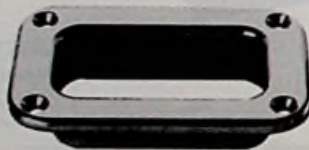

Fig. 1250

Chrome Plated Zinc

ORDERING INFORMATION

Dimensions Outside Inches	Dimensions Inside Inches	Length Spigot Inches	Std. Pkg.-1 pc. OEM Pkg.-10 pcs.	Screw Size	Weight Pounds
3 5/8 x 5 5/8	2 1/16 x 4 1/16	1	1250 000 CHR	1/4	3/4

HAWSE HOLE PLATE FIG. 752



Fig. 752

Chrome Plated Forged Bronze

ORDERING INFORMATION

Dimensions Outside Inches	Dimensions Inside Inches	Length Spigot Inches	Std. Pkg.-1 pc. OEM Pkg.-10 pcs.	Screw Size	Weight Pounds
4 1/4 x 6	2 1/8 x 4 1/8	1 1/4	752 000 CHR	1/4	1 1/2

ROPE AND CHAIN DECK PIPE FIG. 750

Chrome Plated Forged Bronze

The Cover Has a Hook for Hanging Chain and a Stainless Steel Cable Retainer.

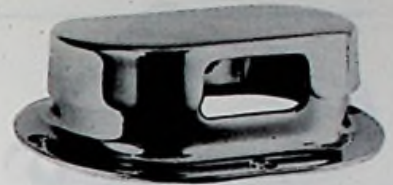

Fig. 750

Opening For Chain Size Inches	Dimensions		ORDERING INFORMATION			
	Flange Inches	Height Overall Inches	Display Pkg.-5 pcs. 1 Pc. per card	Screw Size	Weight Pounds	
3/8	5 1/4 x 4	1 3/8	750 DP CHR	8	2	

Spare Cover with Hook and Cable, Cat. No. 750 DP 99A



ROPE DECK PIPE FIG. 1057

U.V. Stabilized, Fiber Reinforced, High Impact Black or White Plastic

Hinged, Snap-Down Cover



Fig. 1057

Color	Max. Rope Size		ORDERING INFORMATION			
	Inches	O.D. Flange Inches	Display Pkg.-5 pcs. 1 Pc. per card	OEM Bulk Pkg. 25 pcs.	Screw Size	Weight Ounces
Black	7/8	3 3/4	1057 DP BLK	1057 000 BLK	8	3 1/4
White	7/8	3 3/4	1057 DP WHT	1057 000 WHT	8	3 1/4



ROPE DECK PIPE FIG. 741

Chrome Plated Bronze

ORDERING INFORMATION

Max. Rope Size Inches	O.D. Flange Inches	Display Pkg.-5 pcs. 1 Pc. per card		Screw Size	Weight Pounds
		Display Pkg.-5 pcs. 1 Pc. per card	OEM Bulk Pkg. 10 pcs.		
5/8	3	741 DP0 CHR	741 000 CHR	8	3/4
1	4 1/4	741 DP1 CHR	-----	8	1 5/8

Spare No. 0 Cap with Chain, Cat. No. 741 DP0 99A.
Spare No. 1 Cap with Chain, Cat. No. 741 DP1 99A



Fig. 741

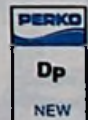

ROPE DECK PIPE FIG. 757

Chrome Plated Zinc

ORDERING INFORMATION

Max. Rope Size Inches	O.D. Flange Inches	Display Pkg.-5 pcs. 1 Pc. per card		Screw Size	Weight Pounds
		Display Pkg.-5 pcs. 1 Pc. per card	OEM Bulk Pkg. 10 pcs.		
1	3 3/8	757 DP CHR	757 000 CHR	8	1/2



Fig. 757



ANCHOR CHOCKS FIG. 903

Chrome Plated Bronze
Polished or Burnished

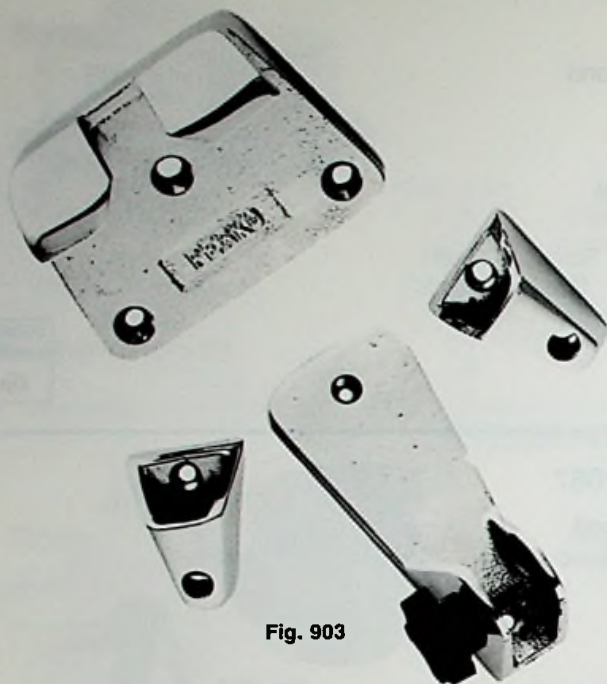

Fig. 903

Size No. 1 Fits		
Fortress™ Models FX7-FX16	H°500	T™570
	H°960	T™1200
	H°1500	T™1800
	S°160	T™2500
	S°300	T™3000
U.S. Anchor Mfg., INC. Models 2½, 4, 8, 13	S°600	D™375
	S°920	D™750
	S°1300	D™1150
	VSΒ™900	D™1650
	VSΒ™13000	
	VSΒ™1900	
Size No. 2 Fits		
Fortress™ Models FX23-FX55	H°1800	T™4000
	H°3100	T™6000
	H°3600	T™7000
	D™2000	
	D™2500	
U.S. Anchor Mfg., INC. Models 18 & 22	S°1600	
	S°2000	
	S°3000	
	VSΒ™2500	
	VSΒ™3600	

ORDERING INFORMATION

Polished Chrome Plated Bronze	Burnished Chrome Plated Bronze	Screw Size	Weight Per Set Pounds
Display Pkg.-5 cds. 1 Set per card	Display Pkg.-5 cds. 1 Set per card		
903 DP1 CHR	903 DP1 BUR	10	2
903 DP2 CHR	903 DP2 BUR	10	2 ¼

SPARE PARTS ORDERING INFORMATION

To Specify Size Replace the Sixth Digit With the Size Number (ie. 903 001 99A or 903 B01 99A).



Spare Polished Chrome Shank Support, Cat. No. 903 000 99A.
Spare Pair, Polished Chrome Fluke Supports, Cat. No. 903 000 99B.
Spare Polished Chrome Crown Support, Cat. No. 903 000 99C.
Spare Knob, Cat. No. 1144 A00 BLK.

Spare Burnished Chrome Shank Support, Cat. No. 903 B00 99A.
Spare Pair, Burnished Chrome Fluke Supports, Cat. No. 903 B00 99B.
Spare Burnished Chrome Crown Support, Cat. No. 903 B00 99C.



Fig. 759

DOCK LINE SPRING FIG. 759

Galvanized Spring Steel

ORDERING INFORMATION

For Rope Size Inches	Length Overall Inches	O.D. Inches	Compression Inches	Standard Package-5 pcs.	Weight Pounds
½	10	1 ½	4 ½	759 001 ZNC	7/8

NOTE: The Bow Eyes and Transom Eyes Illustrated on this Page are not Designed to Bear the Weight of the Vessel and Therefore Should Not Be Used For Lifting.

BOW EYE FIG. 237

**Non-Magnetic 300 Series Stainless Steel Shank
Stainless Steel Nuts & Washers**



Fig. 237

ORDERING INFORMATION

Length Shank Inches	O.D. Shank Inches	I.D. Eye Inches	Length Thread Inches	Display Pkg.-10 pcs. 1 Pc. per card	OEM Bulk Pkg. 25 pcs.	Weight Ounces	Safe Working Load Pounds
3	5/16	1	3	237 DP1 STS	237 001 STS	4	1800
6	5/16	1	6	237 DP2 STS	-----	5 1/2	1800
3	3/8	1 1/8	3	*237 DP3 STS	237 003 STS	5	3000
3 1/4	1/2	1 1/2	3 1/4	*237 DP4 STS	-----	12	4600

* Display Pkg., 5 pcs., 1 Pc. per card.



BOW EYE FIG. 1235

**Chrome Plated Zinc Eye
Zinc Plated Steel "U" Bolt, Nuts & Washers**

Safe Working Load 2000 Pounds

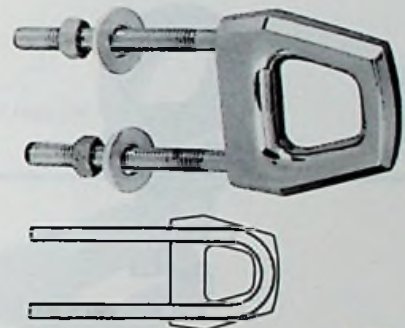

Fig. 1235

ORDERING INFORMATION

Length Shank Inches	O.D. Shank Inches	I.D. Eye Inches	Length Thread Inches	Display Pkg.-10 pcs. 1 Pc. per card	Weight Ounces
3	5/16	1	2 3/4	1235 DP CHR	11



TRANSOM EYE FIG. 236

**Non-Magnetic 300 Series Stainless Steel Shank
Stainless Steel Finishing Plate, Nuts & Washers**

For Use as Towing or Lashing Eye.

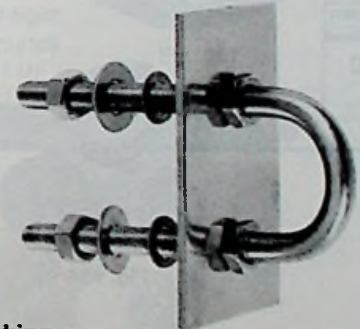

Fig. 236

ORDERING INFORMATION

Length Shank Inches	O.D. Shank Inches	I.D. Eye Inches	Dimensions Plate Inches	Display Pkg.-5 pcs. 1 Pc. per card	Weight Ounces	Safe Working Load Pounds
3	5/16	1	3 x 1 3/4	*236 DP1 STS	6	1800
3	3/8	1 1/8	3 x 1 3/4	236 DP3 STS	10	3000
3 1/4	1/2	1 1/2	4 x 1 3/4	236 DP4 STS	14 1/2	4600

* Display Pkg., 10 pcs., 1 Pc. per card.



IMPORTANT NOTE: The Safe Working Load Information Given for the Items Above is Based on a Straight Axial Pull. This Information Would Not Apply In Cases Where Installation or Use Creates Angular Loading Since These Variations Make It Impracticable to Offer Accurate Test Data.

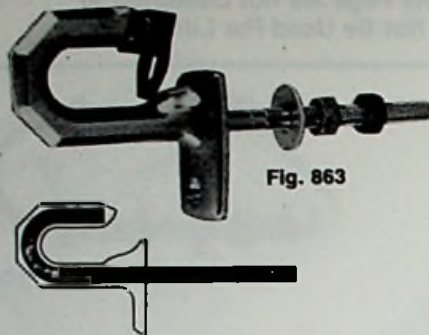

Fig. 863

WATER SKI TOWING HOOK FIG. 863

Chrome Plated Zinc Body
Zinc Plated Steel Shank, Nuts & Washers

ORDERING INFORMATION

Length Overall Inches	Length Shank Inches	O.D. Shank Inches	Length Thread Inches	Display Pkg.-5 pcs. 1 Pc. per card	Weight Ounces
6	3 1/4	5/16	2 1/2	863 DP CHR	10



LIFTING EYE FIG. 429

Chrome Plated Manganese Bronze
Integral Flange

Safe Working Load 3000 Pounds



Fig. 429

ORDERING INFORMATION

For Rod Inches	I.D. Eye Inches	O.D. Eye Inches	O.D. Base Inches	Standard Pkg.-1 pc.	Screw Size	Weight Ounces
5/8	1 1/2	2 1/4	2 1/4	429 000 CHR	8	19

LIFTING EYE AND CLEAT FIG. 434

Chrome Plated Manganese Bronze

Safe Working Load 4000 Pounds



Fig. 434

ORDERING INFORMATION

For Rod Inches	I.D. Eye Inches	Length Overall Inches	Dimensions Base Inches	Display Pkg.-5 pcs. 1 Pc. per card	Screw Size	Weight Ounces
5/8	1 1/16	5 1/16	3 1/2 x 2 1/2	434 DP CHR	10	18

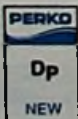

IMPORTANT NOTE: The Safe Working Load Information Given for the Items Above is Based on a Straight Axial Pull. This Information Would Not Apply in Cases Where Installation or Use Creates Angular Loading Since These Variations Make it Impracticable to Offer Accurate Test Data.

STEP PLATE FIG. 1043

**Chrome Plated Bronze Frames
Soft Black Plastic Pads**

ORDERING INFORMATION

Dimensions Inches	Display Pkg.-5 pcs. 1 Pc. per card	Screw Size	Weight Ounces
8 3/4 x 3 1/4	1043 DP1 CHR	6	8
11 1/2 x 5 3/4	1043 DP2 CHR	8	12

Spare Pads for Size No. 1 (2 per bag), Cat. No. 1050 DP1 BLK.
Spare Pads for Size No. 2 (2 per bag), Cat. No. 1050 DP2 BLK.



Fig. 1043



STEP PLATE FIG. 1325

**Chrome Plated Zinc Frames
Soft Black Plastic Pads**

ORDERING INFORMATION

Dimensions Inches	Display Pkg.-5 cds. 2 Pcs. per card	OEM Bulk Pkg. 50 pcs.	Screw Size	Weight Ounces
8 3/8 x 2 1/4	1325 DP0 CHR	1325 000 CHR	8	5
8 3/4 x 3 1/4	1325 DP1 CHR	1325 001 CHR	8	8

Spare Pads for Size No. 0 (2 per bag), Cat. No. 1050 DP0 BLK. Spare Pads for Size No. 1 (2 per bag), Cat. No. 1050 DP1 BLK.



Fig. 1325



FIXED STEPS FIGS. 351 & 501

Chrome Plated Bronze

ORDERING INFORMATION

Dimensions Step Inches	Dimensions Bracket Inches	Display Pkg.-5 pcs. 1 Pc. per card	Standard Package-1 pc.	Bolt Size	Weight Pounds
6 x 4 1/4	6 x 2	351 DP CHR	-----	5/16 R.H.	1 1/8
11 x 4 1/2	11 x 2	-----	501 000 CHR	5/16 R.H.	2 7/8



Fig. 351



Fig. 501



FOLDING STEP FIG. 344

Chrome Plated Bronze

Stainless Steel Spring Holds Step in Open or Closed Position.

ORDERING INFORMATION

Dimensions Step Inches	Dimensions Bracket Inches	Projection Folded Inches	Display Pkg.-5 pcs. 1 Pc. per card	Bolt Size	Weight Pounds
4 1/8 x 2 1/4	4 1/4 x 1 3/4	1 3/8	344 DP CHR	5/16 R.H.	1 1/2

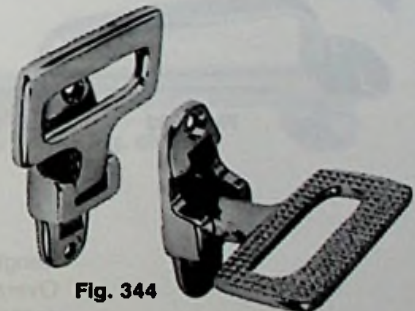

Fig. 344



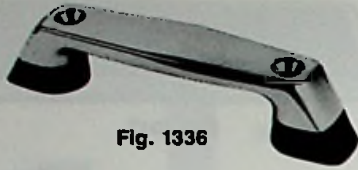

Fig. 1336

CHROMALEX® HANDLE FIG. 1336

Chrome Plated Zinc
Black Plastic Bases

ORDERING INFORMATION

Length Overall Inches	Length Inside Inches	Height Inside Inches	Display Pkg.-5 cds. 2 Pcs. per card	OEM Bulk Pkg. 50 pcs.	Screw Size	Weight Ounces
6 1/4	3 1/2	1	1336 DP CHR	1336 000 CHR	1/4	10

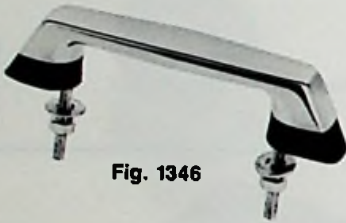

Fig. 1346

CHROMALEX® HANDLE FIG. 1346

Chrome Plated Zinc
Black Plastic Bases

ORDERING INFORMATION

Length Overall Inches	Length Inside Inches	Height Inside Inches	Std Pkg.-10 pcs. OEM Bulk Pkg.-50 pcs.	Stud Size	Weight Ounces
6 1/4	3 1/2	1	1346 000 CHR	1/4 - 20 x 1 1/2	10

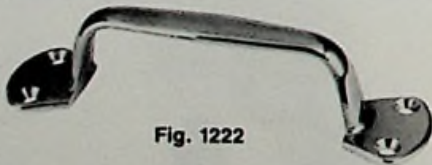

Fig. 1222

HANDLE FIG. 1222

Chrome Plated Zinc

ORDERING INFORMATION

Length Overall Inches	Length Inside Inches	Height Inside Inches	Display Pkg.-5 cds. 2 Pcs. per card	OEM Bulk Pkg. 100 pcs.	Screw Size	Weight Ounces
5 3/4	3 5/8	1 1/4	1222 DP CHR	1222 000 CHR	8	3 1/2



HANDLE FIG. 1231

Chrome Plated Zinc



Fig. 1231

ORDERING INFORMATION

Length Overall Inches	Length Inside Inches	Height Inside Inches	Display Pkg.-5 cds. 2 Pcs. per card	OEM Bulk Pkg. 50 pcs.	Screw Size	Weight Ounces
6	3 1/2	1 5/16	1231 DP CHR	1231 000 CHR	1/4	7 1/4



HANDLE FIG. 775

Chrome Plated Bronze



Fig. 775

ORDERING INFORMATION

Length Overall Inches	Length Inside Inches	Height Inside Inches	Display Pkg.-5 cds. 2 Pcs. per card	OEM Bulk Pkg. 50 pcs.	Screw Size	Weight Ounces
4 1/4	2 1/2	7/8	775 DP1 CHR	775 001 CHR	6	2
5 3/4	3 5/8	1 3/8	775 DP2 CHR	775 002 CHR	8	4



GRAB RAIL FIG. 491

Chrome Plated Zinc End Posts

Polished 18-8 Stainless Steel Tube

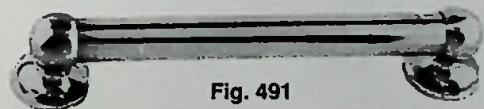

Fig. 491



ORDERING INFORMATION

Length Overall Inches	Length Inside Inches	Height Inside Inches	Display Pkg.-5 pcs. 1 Pc. per card	Screw Size	Weight Pounds
9 1/2	7	3/4	491 DP1 CHR	6	3/4
15 5/8	13	3/4	491 DP2 CHR	6	1



FLUSH FLAG POLE SOCKETS FIGS. 218 & 219



Bow
Fig. 218



Stern
Fig. 219

Chrome Plated Bronze

Fig. 218 — Bow Socket

Fig. 219 — Stern Socket

ORDERING INFORMATION

	I.D. Socket Inches	O.D. Flange Inches	Depth Socket Inches	Fig. 218 Display Pkg.-5 pcs. 1 Pc. per card	Fig. 219 Display Pkg.-5 pcs. 1 Pc. per card	Screw Size	Weight Ounces
	3/4	2	1 1/2	218 DP1 CHR	219 DP1 CHR	8	4 1/2
	1	2 3/8	1 3/4	218 DP2 CHR	219 DP2 CHR	8	5
	1 1/4	2 5/8	2	218 DP3 CHR	219 DP3 CHR	8	9

PERKO

Dp

NEW

UPRIGHT FLAG POLE SOCKETS FIGS. 220 & 221



Bow
Fig. 220



Stern
Fig. 221

Chrome Plated Bronze

Fig. 220 — Bow Socket

Fig. 221 — Stern Socket

ORDERING INFORMATION

	I.D. Socket Inches	O.D. Base Inches	Height Overall Inches	Fig. 220 Display Pkg.-5 pcs. 1 Pc. per card	Fig. 221 Display Pkg.-5 pcs. 1 Pc. per card	Screw Size	Weight Ounces
	3/4	2 1/8	1 3/4	220 DP1 CHR	221 DP1 CHR	8	5 1/4
	1	2 1/2	2	220 DP2 CHR	221 DP2 CHR	8	6 3/4
	1 1/4	2 3/4	2 1/8	220 DP3 CHR	221 DP3 CHR	8	10 3/4

PERKO

Dp

NEW

CLAMP-ON FLAG POLE SOCKET FIG. 1302



Fig. 1302

Chrome Plated Zinc
Black Plastic Knob

For Rail Sizes 3/4 or 1 Inch.

ORDERING INFORMATION

I.D. Socket Inches	Dimensions Bracket Inches	Display Pkg.-5 pcs. 1 Pc. per Card	Weight Ounces
3/4	2 x 1 3/4	1302 DP CHR	11

PERKO

Dp

FLAG STAFF FIG. 495

Chrome Plated Zinc Base and Top
Anodized Aluminum Tube

Sizes 2 and 3 For Use With Fig. 1302 Clamp-On Socket Only.

ORDERING INFORMATION

O.D. Base Inches	Length Overall Inches	Display Pkg.-5 bags 1 Pc. per bag	Weight Ounces
1/2	14	495 DP1 CHR	3
3/4	14	495 DP2 CHR	4
3/4	18	495 DP3 CHR	5

PERKO

Dp



Fig. 495

GRAB RAIL POSTS FIGS. 1297 & 1298

Chrome Plated Zinc

Fig. 1297 — End Post
Fig. 1298 — Center Post

Hollow, For 3/4 Inch O.D. Tubing



Fig. 1297 End Post



Fig. 1298 Center Post

ORDERING INFORMATION

Height Overall Inches	O.D. Base Inches	Fig. 1297 Standard Pkg.-4 pcs.	Fig. 1298 Standard Pkg.-2 pcs.	Screw Size	Weight Ounces
1 3/4	1 5/8	1297 000 CHR	1298 000 CHR	6	2 3/4

GRAB RAIL POSTS FIGS. 380 & 380A

Chrome Plated Bronze

Fig. 380 — End Post
Fig. 380A — Center Post

Hollow, For 1 Inch O.D. Tubing



Fig. 380 End Post



Fig. 380A Center Post

ORDERING INFORMATION

Height Overall Inches	O.D. Base Inches	Fig. 380 Standard Pkg.-1 pc.	Fig. 380A Standard Pkg.-1 pc.	Screw Size	Weight Ounces
3 3/8	2 1/2	380 000 CHR	380 A00 CHR	8	10

GRAB RAIL POSTS FIGS. 413 & 413A

Chrome Plated Bronze

Fig. 413 — End Post
Fig. 413A — Center Post

Hollow, For 1 Inch O.D. Tubing
with .035 Inch Wall Thickness



Fig. 413 End Post



Fig. 413A Center Post

ORDERING INFORMATION

Height Overall Inches	Dimensions		Standard Pkg.-1 pc.	Screw Size	Weight Ounces
	Base Inches				
2 1/4	3 x 2		413 000 CHR	8	10
2 1/4	2 3/4 x 1 1/2		413 A00 CHR	8	7 1/4

AXE BRACKETS FIG. 325

Stainless Steel



Fig. 325

ORDERING INFORMATION

For Blade Width Inches	Standard Pkg.-10 sets	Socket Screw Size	Bracket Screw Size	Weight per Set Ounces
6	325 000 STS	10 R.H.	6	4 1/2

FITTINGS FOR WOOD GUARD RAILS

FIGS. 180 & 185

Chrome Plated Bronze

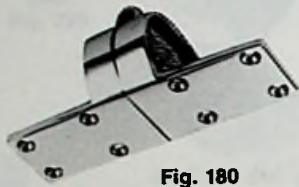

Fig. 180

Hinge — Fig. 180

Latch — Fig. 185



Fig. 185

ORDERING INFORMATION

For Rail Dimensions Inches	Length Overall Inches	Fig. 180 Standard Pkg.-1 pc.	Fig. 185 Standard Pkg.-1 pc.	Screw Size	Weight Pounds
2 3/8 x 1 3/8	5	180 001 CHR	185 001 CHR	8	3/4
2 7/8 x 1 1/4	5 1/2	180 002 CHR	185 002 CHR	8	1

TRANSOM PLATES

FIG. 1224

Chrome Plated Zinc
Soft Black Plastic Pads



Fig. 1224

ORDERING INFORMATION

Length Overall Inches	O.D. Pad Inches	Display Pkg.-10 cds. 1 Pair per card	Screw Size	Weight per Pair Ounces
3 1/2	1 7/8	1224 DP CHR	8	2 3/4



RING BUOY HOLDER

FIG. 1017

Brass
Plain or Chrome Plated



Fig. 1017

ORDERING INFORMATION

Width Mounting Plate Inches	Height Overall Inches	Chrome Plated Brass Display Pkg.-5 pcs. 1 Pc. per card	Chrome Plated Brass OEM Bulk Pkg. 20 pcs.	Plain Brass Standard Pkg.-5 pcs.	Screw Size	Weight Pounds	PERKO Dp
3	4 1/2	1017 DP CHR	1017 000 CHR	1017 000 PLB	8	1/2	

BOAT HOOK HOLDERS

FIG. 492

Stainless Steel



Fig. 492

ORDERING INFORMATION

Maximum Pole O.D. Inches	Length Inches	Width Inches	Display Pkg.- 10 cds. 1 Pr. per card	OEM Bulk Pkg. 50 pairs.	Screw Size	Weight per Pair Ounces	PERKO Dp
1 1/2	3 1/2	1	492 DP STS	492 000 STS	6	1 1/2	

POLE STORAGE CLIPS

FIG. 477

Soft Black Plastic



Fig. 477

ORDERING INFORMATION

For Pole O.D. Inches	Display Pkg.-10 cds. 1 Pr. per card	OEM Bulk Pkg. 50 pairs	Screw Size	Weight per Pair Ounces	PERKO Dp
3/4	477 DP BLK	477 DP BLK	8	3	

SPRING CLAMPS

FIG. 502

Stainless Steel



Fig. 502

ORDERING INFORMATION

Min. I.D. Inches	Max. I.D. Inches	Projection Inches	Width Clamp Inches	Display Pkg.-10 cds. 1 Pr. per card	Screw Size	Weight per Pair Ounces	PERKO Dp
5/8	1 1/4	1 1/2	1/2	502 DP1 STS	6 R.H.	2	
1	1 3/4	2 1/4	5/8	502 DP2 STS	6 R.H.	2 1/2	

ROPE PULLEY FIG. 1255



Fig. 1255

**Chrome Plated Zinc
White Plastic Sheave**

Coaming Type
Maximum Rope Size 1/4 Inch.



ORDERING INFORMATION

O.D. Sheave Inches	Dimensions Plate Inches	Display Pkg. - 10 pcs. 1 Pc. per card	Screw Size	Weight Ounces
2 5/16	4 7/8 x 1 1/4	1255 DP CHR	6	1/2

ROPE PULLEY FIG. 565



Fig. 565

**Stainless Steel
White Plastic Sheave**

Swivel Type with Strap
Maximum Rope Size 1/4 Inch.



ORDERING INFORMATION

O.D. Sheave Inches	Length Overall Inches	Length Strap Inches	Display Pkg. - 5 cds. 2 Pcs. per card	Screw Size	Weight Ounces
2 5/16	3 3/4	1 5/8	565 DP	10 R.H.	2

ROPE PULLEY FIG. 634



Fig. 634

**Stainless Steel
White Plastic Sheave**

Swivel Snap Hook Type
Maximum Rope Size 1/4 Inch.



ORDERING INFORMATION

O.D. Sheave Inches	Length Overall Inches	Opening Snap Throat Inches	Display Pkg. - 5 cds. 2 Pcs. per card	Weight Ounces
2 5/16	4 5/8	1/2	634 DP	2 1/2

ROPE CLAMP FIG. 358

Plain Cast Bronze

For 1/8 or 3/16 Inch Rope.



Fig. 358

ORDERING INFORMATION

Length Overall Inches	Width Inches	Display Pkg. - 10 cds. 2 Pcs. per card	OEM Bulk Pkg. 100 pcs.	Weight Ounces
1 1/4	11/16	358 DP PLB	358 000 PLB	1



ROPE CLAMP FIG. 1226

Chrome Plated Zinc

For 1/8 or 3/16 Inch Rope.



Fig. 1226

ORDERING INFORMATION

Length Overall Inches	Width Inches	Display Pkg. - 25 cds. 2 Pcs. per card	Weight Ounces
1 1/4	11/16	1226 DP CHR	1



ROPE GUIDES FIGS. 1256 & 1261

Chrome Plated Zinc



Fig. 1256



Fig. 1261

ORDERING INFORMATION

I.D. Hole Inches	Dimensions Base Inches	Display Pkg. - 25 cds. 2 Pcs. per card	OEM Bulk Pkg. 100 pcs.	Screw Size	Weight Ounces
5/16	1 1/4 x 3/4	1256 DP CHR	1256 000 CHR	6	1/2
5/16	1 1/4 x 3/4	1261 DP CHR	1261 000 CHR	6	1/2





Fig. 1243

ROPE GUIDE FIG. 1243

**Chrome Plated Zinc
Black Plastic Sheave**

ORDERING INFORMATION

Maximum Rope Size Inches	O.D. Sheave Inches	Dimensions Base Inches	Display Pkg.-10 pcs. 1 Pc. per card	Screw Size	Weight Ounces
1/4	7/8	2 x 3/4	1243 DP CHR	8	1 3/4



Fig. 732

ROPE TIGHTENER FIG. 732

**Zinc Plated Spring Steel
or
Stainless Steel**

ORDERING INFORMATION

Finish	Length Normal Inches	Length Compressed Inches	O.D. Inches	Display Pkg.-5 cds. 2 Pcs. per card	Weight Ounces
Zinc	4	5	1	732 DP CAD	3 1/2
Stainless	4	5	1	732 DP STS	2 1/4



Fig. 754

ROPE TIGHTENER FIG. 754

Zinc Plated Spring Steel

ORDERING INFORMATION

Length Normal Inches	Length Compressed Inches	O.D. Inches	Display Pkg.-10 cds. 2 Pcs. per card	Weight Ounces
4 3/4	6 1/2	7/8	754 DP CAD	2 3/4



EYE STRAP FIG. 881

Chrome Plated Forged Bronze



Fig. 881

Length Overall Inches	I.D. Eye Inches	O.D. Stock at Eye Inches	ORDERING INFORMATION			
			Display Pkg.-25 cds. 2 Pcs. per card	OEM Bulk Pkg. 50 pcs.	Screw Size	Weight Ounces
1 7/8	1/4	1/4	881 DP0 CHR	881 000 CHR	8	1/2
2 1/4	5/16	9/32	881 DP1 CHR	881 001 CHR	10	3/4
2 3/4	1/2	5/16	*881 DP2 CHR	**881 002 CHR	10	1 1/2

*Display Pkg.-10 cards, 2 Pcs. per card.

**OEM Bulk Pkg.-20 pcs.



EYE STRAP FIG. 1242

Chrome Plated Zinc



Fig. 1242

Length Overall Inches	I.D. Eye Inches	ORDERING INFORMATION			
		Display Pkg.-10 cds. 5 Pcs. per card	OEM Bulk Pkg. 100 pcs.	Screw Size	Weight Ounces
1 7/8	5/16	1242 DP CHR	1242 000 CHR	8	1/4



EYE STRAP FIG. 562

300 Series Stainless Steel



Fig. 562

Length Overall Inches	I.D. Eye Inches	ORDERING INFORMATION			
		Display Pkg.-10 cds. 5 Pcs. per card	OEM Bulk Pkg. 100 pcs.	Screw Size	Weight Ounces
1 5/8	1/4	562 DP STS	562 000 STS	10 R.H.	1/8

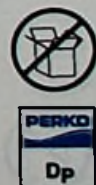

FENDER LOCK FIG. 1299

Chrome Plated Zinc

The Eye is to be Permanently Attached to the Fender Line.



Fig. 1299



ORDERING INFORMATION

I.D. Eye Inches	O.D. Flange Inches	Display Pkg.-10 cds. 2 Pcs. per card	Screw Size	Weight Ounces
3/8	1 1/2	1299 DP CHR	8	1

Spare Eye, Cat. No. 1299 000 99A.

FENDER HOOK FIG. 1246

Chrome Plated Zinc



Fig. 1246



ORDERING INFORMATION

Maximum Rope Size Inches	Dimensions Plate Inches	Display Pkg.-10 cds. 2 Pcs. per card	Screw Size	Weight Ounces
3/8	1 3/4 x 1 1/4	1246 DP CHR	6	1 1/4

SNAP TYPE FENDER HOOK FIG. 1309

Chrome Plated Zinc



Fig. 1309



ORDERING INFORMATION

Maximum Rope Size Inches	Dimensions Plate Inches	Display Pkg.-10 cds. 2 Pcs. per card	OEM Bulk Pkg. 100 pcs.	Screw Size	Weight Ounces
1/4	1 8/16 x 1 3/8	1309 DP CHR	1309 000 CHR	6	1 1/2

FAST EYE SNAP HOOK FIG. 614

Non-Magnetic 316 Series Stainless Steel

Interlocking Tongue



Fig. 614



ORDERING INFORMATION

I.D. Eye Inches	Length Overall Inches	O.D. Stock Inches	Standard Pkg.-10 pcs.	Weight Ounces	Safe Working Load Pounds
3/8	3	5/16	614 000 STS	2 1/2	350

NOTE: The Snaps Illustrated Below Should Not Be Used For Lifting, Winching, Towing, Mooring or Like Applications.

FAST EYE BOAT SNAP FIG. 612

Plain Bronze

ORDERING INFORMATION

I.D. Eye Inches	Length Overall Inches	Standard Pkg.-10 pcs.	Weight Ounces
3/8	2 1/16	612 000 PLB	1
5/8	2 7/8	612 001 PLB	1 1/2
3/4	3	612 002 PLB	2
3/4	3 7/8	612 003 PLB	4



Fig. 612



SWIVEL EYE BOAT SNAP FIG. 613

Plain Bronze

ORDERING INFORMATION

I.D. Eye Inches	Length Overall Inches	Standard Pkg.-10 pcs.	Weight Ounces
9/16	3 1/4	613 001 PLB	2
11/16	3 5/8	613 002 PLB	3
3/4	4 5/8	613 003 PLB	4



Fig. 613



SWIVEL EYE SNAP FIG. 659

Plain Bronze

ORDERING INFORMATION

I.D. Eye Inches	I.D. Hook Inches	Length Overall Inches	Display Pkg.-10 pcs. 1 Pc. per card	OEM Bulk Pkg. 100 pcs.	Weight Ounces
3/4	7/16	3 1/2	659 DP PLB	659 000 PLB	2 1/2



Fig. 659



SWIVEL EYE SNAP FIG. 1289

Chrome Plated Zinc
Interlocking Tongue

ORDERING INFORMATION

I.D. Eye Inches	Length Overall Inches	Display Pkg.-10 pcs. 1 Pc. per card	Weight Ounces
5/8	3	1289 DP CHR	2 1/2



Fig. 1289



NOTE: The Snaps Illustrated Below Should Not Be Used For Lifting, Winching, Towing, Mooring or Like Applications.

SWIVEL EYE BABY SNAP FIG. 1041

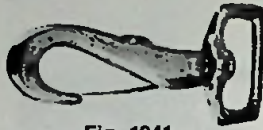

Fig. 1041

Plain Bronze

ORDERING INFORMATION

Dimensions Eye Inches	Length Overall Inches	Standard Pkg.-50 pcs.	Weight Ounces
5/8 x 5/16	1 3/4	1041 000 PLB	1/2



SWIVEL EYE BABY SNAP FIG. 1042



Fig. 1042

Plain Bronze

ORDERING INFORMATION

I. D. Eye Inches	Length Overall Inches	Standard Pkg.-50 pcs.	Weight Ounces
3/8	2 1/8	1042 000 PLB	1/2



FAST EYE BABY SNAP FIG. 842



Fig. 842

Plain Bronze

ORDERING INFORMATION

I. D. Eye Inches	Length Overall Inches	Standard Pkg.-50 pcs.	Weight Ounces
3/8	1 7/8	842 000 PLB	1/2



HAND WINDSHIELD WIPER FIG. 533

**Chrome Plated Zinc
400 Series Stainless Steel Arm and Blade Holder**

For Straight and Curved Windshields, the Arm is Extendable from 6 3/4 to 10 1/2 Inches (Length Overall is 8 to 11 1/2 Inches), and the Spring Tension is Adjustable.

ORDERING INFORMATION

O.D. Shaft Inches	Maximum Thickness of Panel Inches	Length Handle Inches	Length Blade Inches	Display Pkg.-5 pcs. 1 Pc. per card	Weight Ounces
3/8	1 1/8	2 3/8	12	533 DP STS	8

Spare Arm, Cat. No. 533 000 99A.
Spare Handle, Cat. No. 533 000 99D.

Spare Curved Blade, Cat. No. 533 000 99B.

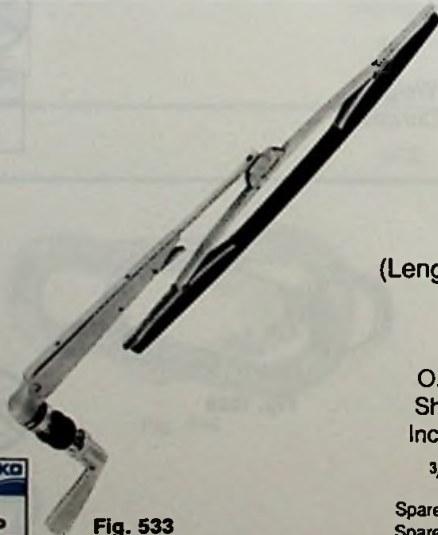

Fig. 533



NORTH RIVER TYPE ROWLOCK HORNS

FIG. 1227

Zinc
Plain or Chrome Plated



Fig. 1227

ORDERING INFORMATION

Finish	O.D.	Length	Between	Display Pkg.-10 cds. 1 Pr. per card	Weight per Pair Ounces
	Shank Inches	Shank Inches	Horns Inches		
Plain	1/2	1 3/4	1 3/4	1227 DP ZNC	10
Chrome	1/2	1 3/4	1 3/4	1227 DP CHR	10



ROUND TYPE ROWLOCK HORNS

FIG. 1267

Zinc
Plain or Chrome Plated



Fig. 1267

ORDERING INFORMATION

Finish	O.D.	Length	I.D.	Display Pkg.-10 cds. 1 Pr. per card	Weight per Pair Ounces
	Shank Inches	Shank Inches	Horn Inches		
Plain	1/2	1 3/4	2	1267 DP ZNC	9 1/2
Chrome	1/2	1 3/4	2	1267 DP CHR	9 1/2



RIBBED TYPE ROWLOCK HORNS

FIG. 1262

Zinc
Plain or Chrome Plated



Fig. 1262

ORDERING INFORMATION

Finish	O.D.	Length	Between	Display Pkg.-10 cds. 1 Pr. per card	Weight per Pair Ounces
	Shank Inches	Shank Inches	Horns Inches		
Plain	1/2	1 3/4	1 3/4	1262 DP ZNC	8
Chrome	1/2	1 3/4	1 3/4	1262 DP CHR	8



TOP MOUNT ROWLOCK SOCKETS

FIG. 1185



Fig. 1185

Zinc
Plain or Chrome Plated
Black Plastic Bearings

ORDERING INFORMATION

Finish	Length Inches	Width Inches	Depth Inches	Display Pkg.-10 cds. 1 Pr. per card	OEM Bulk Pkg. 50 pairs	Weight per Pair Ounces
Plain	2 7/8	1 1/8	1 1/8	1185 DP ZNC	1185 000 ZNC	5
Chrome	2 7/8	1 1/8	1 1/8	1185 DP CHR	1185 000 CHR	5

Screw Size #10.

Spare Plastic Bearing, Cat. No. 1155 000 BLK.



SIDE MOUNT ROWLOCK SOCKETS

FIG. 1186



Fig. 1186

Zinc
Plain or Chrome Plated
Black Plastic Bearings

ORDERING INFORMATION

Finish	Length Inches	Width Inches	Depth Inches	Display Pkg.-10 cds. 1 Pr. per card	Weight per Pair Ounces
Plain	4	7/8	1 1/8	1186 DP ZNC	9
Chrome	4	7/8	1 1/8	1186 DP CHR	9

Screw Size #10.

Spare Plastic Bearing, Cat. No. 1155 000 BLK.



SIDE MOUNT ROWLOCK SOCKETS

FIG. 1187



Fig. 1187

Zinc
Plain or Chrome Plated
Black Plastic Bearings

ORDERING INFORMATION

Finish	Length Inches	Depth Inches	Display Pkg.-10 cds. 1 Pr. per card	Weight per Pair Ounces
Plain	4	1 1/4	1187 DP ZNC	6
Chrome	4	1 1/4	1187 DP CHR	6

Screw Size #10.

Spare Plastic Bearing, Cat. No. 1155 000 BLK.



OAR LEATHERS & BUTTONS

FIG. 233



Fig. 233

Leather

ORDERING INFORMATION

Dimensions Leather Inches	Dimensions Button Inches	Standard Pkg.-5 prs.	Weight per Pair Ounces
7 x 6 1/2	1/2 x 13	233 001	10

Note: Pair Consists of 2 Leathers and 2 Buttons.



NORTH RIVER TYPE ROWLOCK HORNS FIG. 830

Plain Manganese Bronze

ORDERING INFORMATION

O.D. Shank Inches	Length Shank Inches	Between Horns Inches	Display Pkg.-5 cds. 1 Pr. per card	Weight per Pair Ounces
1/2	2 1/8	2 1/8	830 DP PLB	13



Fig. 830



ROUND TYPE ROWLOCK HORNS FIG. 829

Plain Manganese Bronze

ORDERING INFORMATION

O.D. Shank Inches	Length Shank Inches	I.D. Horn Inches	Display Pkg.-5 cds. 1 Pr. per card	Weight per Pair Ounces
1/2	2 1/8	2	829 DP0 PLB	14
1/2	2 1/8	2 1/4	829 DP1 PLB	16



Fig. 829



RIBBED TYPE ROWLOCK HORNS FIG. 828

Plain Manganese Bronze

ORDERING INFORMATION

O.D. Shank Inches	Length Shank Inches	Between Horns Inches	Display Pkg.-5 cds. 1 Pr. per card	Weight per Pair Ounces
1/2	2 1/8	2	828 DP PLB	13



Fig. 828



ROWLOCK SOCKETS FIGS. 831, 832 & 833

Plain Manganese Bronze

ORDERING INFORMATION

Length Inches	Width Inches	Depth Inches	Display Pkg.-5 cds. 1 Pr. per card	Weight per Pair Ounces
2 3/8	7/8	1	831 DP PLB	4
3 5/8	---	1 3/8	832 DP PLB	7
4	3/4	1 3/4	833 DP PLB	8



Fig. 833



Fig. 831



Fig. 832



Screw Size #10.

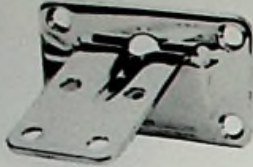

TABLE BRACKETS FIG. 148

Chrome Plated Brass

For Removable Tables

Supplied in Sets Consisting of Two Brackets and Two Wall Plates.



Fig. 148

Dimensions
Angle Bracket
Inches
2 3/4 x 1 11/16

Dimensions
Wall Plate
Inches
3 3/8 x 2

ORDERING INFORMATION

Display Pkg.-5 cds. 1 Set per card	OEM Bulk Pkg. 25 sets	Screw Size	Weight per Set Ounces
148 DP CHR	148 000 CHR	10	12

Spare Angle Brackets, Cat No. 148 000 99A.

Spare Wall Plates, Cat No. 148 000 99B.



LADDER LOCKS FIG. 669

Chrome Plated Bronze

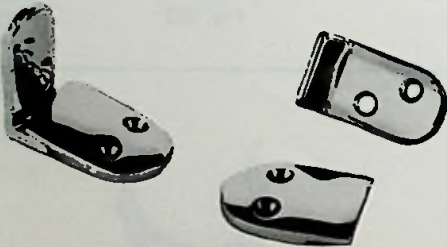

Fig. 669

ORDERING INFORMATION

Height Overall Inches	Length Socket Inches	Length Bracket Inches	Std. Pkg.-5 sets OEM Pkg.-25 sets	Screw Size	Weight per Set Ounces
1 1/4	1	1 3/4	669 000 CHR	8	12

Spare Pair of Sockets, Cat. No. 669 000 99A.

SAIL MAKER'S PALM FIG. 411

**Leather
Right Hand**



Fig. 411

ORDERING INFORMATION

Standard Pkg.-10 pcs.	Weight Ounces
411	2



WINDSHIELD ADJUSTERS FIGS. 1290 & 1291

Chrome Plated Zinc
Black Plastic Knob

Fig. 1290 — Side Mount
Fig. 1291 — Offset Mount

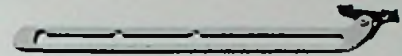

Side
Mount
Fig. 1290

Offset
Mount
Fig. 1291

ORDERING INFORMATION

Length Overall Inches	Length Adjustment Inches	Display Pkg.-5 cds. 1 Pair per card	OEM Bulk Pkg. 10 pairs	Screw Size	Weight per Pair Pounds
12	9 1/2	1290 DP CHR	1290 000 CHR	8	1 1/2
12	9 1/2	1291 DP CHR	1291 000 CHR	8	1 1/2

SPARE PARTS ORDERING INFORMATION

Figure No.	Port Adjuster	Starboard Adjuster	Mounting Bracket With Knob	Knob Only
1290	1290 P00 99A	1290 S00 99A	1290 000 99B	1292 000 BLK
1291	1291 P00 99A	1291 S00 99A	1291 000 99B	1292 000 BLK

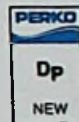

NOTE: Illustration is Port Side.

WINDSHIELD ADJUSTER FIG. 82

Chrome Plated Brass and Bronze
Black Plastic Knob

ORDERING INFORMATION

Length Overall Inches	Length Adjustment Inches	Standard Pkg.-1 pair	Screw Size	Weight per Pair Pounds
12	9 1/2	82 000 CHR	8	2 3/8

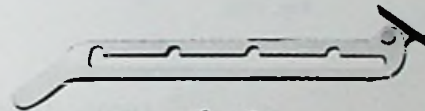

Fig. 82

Spare Port Adjuster, Cat. No. 82 P00 99B.
Spare Starboard Adjuster, Cat. No. 82 S00 99B.
Spare Knob, Cat. No. 82 000 99A.

NOTE: Illustration is Port Side.

WINDSHIELD ADJUSTER FIG. 360

Chrome Plated Brass and Zinc
Black Plastic Knob

ORDERING INFORMATION

Length Base Overall Inches	Length Windshield Arm Inches	Length Adjustment Inches	Standard Pkg.-1 pc.	Bracket Screw Size	Deck Socket Screw Size	Weight Pounds
27 1/2	23	22 1/2	360 000 CHR	8	6	3 3/4

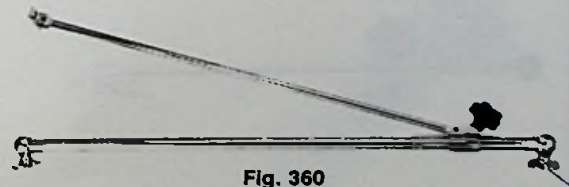

Fig. 360

Spare Knob, Cat. No. 360 000 99A.
Spare Slide Body & Pad, Cat. No. 360 000 99B.

WINDSHIELD ADJUSTER FIG. 1179

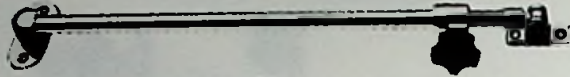

Fig. 1179

**Chrome Plated Brass and Zinc
Black Plastic Knob**

ORDERING INFORMATION

Length Closed Inches	Length Open Inches	O.D. Tube Inches	Display Pkg.-5 pcs. 1 Pc. per card	OEM Bulk Pkg. 20 pcs.	Screw Size	Weight Ounces
10	18	1/2	1179 DP1 CHR	1179 001 CHR	6	9
12	20	1/2	1179 DP2 CHR	1179 002 CHR	6	11

Spare Knob, Cat. No. 1117 DP BLK.



WINDSHIELD ADJUSTER FIG. 1180

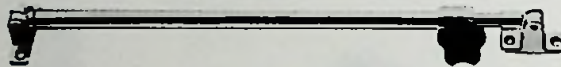

Fig. 1180

**Chrome Plated Brass and Zinc
Black Plastic Knob**

ORDERING INFORMATION

Length Closed Inches	Length Open Inches	O.D. Tube Inches	Display Pkg.-5 pcs. 1 Pc. per card	OEM Bulk Pkg. 20 pcs.	Screw Size	Weight Ounces
12	21	1/2	1180 DP CHR	1180 000 CHR	6	10

Spare Knob, Cat. No. 1117 DP BLK.



WINDSHIELD ADJUSTER FIG. 1116

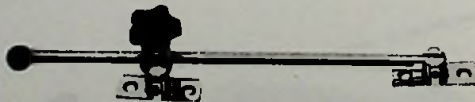

Fig. 1116

**Chrome Plated Brass and Zinc
Black Plastic Knob**

ORDERING INFORMATION

Length Rod Inches	O.D. Rod Inches	Display Pkg.-5 pcs. 1 Pc. per card	OEM Bulk Pkg. 20 pcs.	Screw Size	Weight Ounces
8	3/8	1116 DP1 CHR	1116 001 CHR	8	8
10	3/8	1116 DP2 CHR	1116 002 CHR	8	10
12	3/8	1116 DP3 CHR	1116 003 CHR	8	12

Spare Knob, Cat. No. 1117 DP BLK.



HATCH ADJUSTER FIG. 797

Chrome Plated Brass and Zinc
Black Plastic Knob

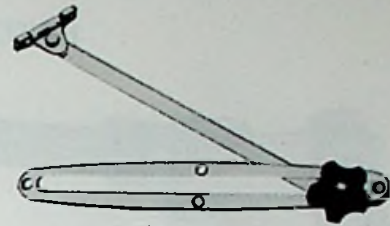

Fig. 797

ORDERING INFORMATION

Length Arm Inches	Length Adjustment Inches	Length Slide Inches	Display Pkg.-5 pcs. 1 Pc. per card	OEM Bulk Pkg. 20 pcs.	Screw Size	Weight Ounces
10	9 1/2	10 3/4	797 DP CHR	797 000 CHR	8	13



HATCH SUPPORT BRACES FIG. 762

Chrome Plated Brass

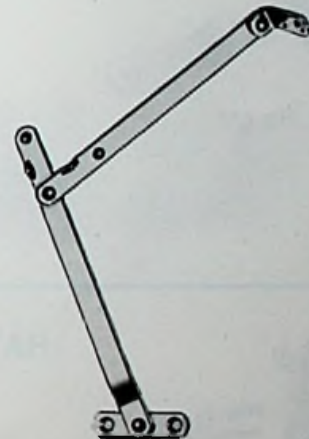

Fig. 762

ORDERING INFORMATION

Length Open Inches	Display Pkg.-5 cds. 1 Pair per card	OEM Bulk Pkg. 20 pcs.	Screw Size	Weight per Pair Ounces
10	762 DP1 CHR	762 001 CHR	8	10
12	762 DP2 CHR	762 002 CHR	8	12
14	762 DP3 CHR	762 003 CHR	8	14

NOTE: Illustration is Port Side.



HATCH FASTENER OR WINDSHIELD KEEPER FIG. 155

Chrome Plated Brass and Zinc
Phosphor Bronze Spring



Fig. 155

ORDERING INFORMATION

Length Overall Inches	Dimensions Mounting Base Inches	Display Pkg.-5 pcs. 1 Pc. per card	OEM Bulk Pkg. 50 pcs.	Screw Size	Weight Ounces
3 7/8	1 1/2 X 9/16	155 DP CHR	155 000 CHR	6	3 1/4



HATCH FASTENER OR WINDSHIELD KEEPER FIG. 769



Fig. 769

**Chrome Plated Brass and Zinc
Black Plastic Handle**

ORDERING INFORMATION

Dimensions	Display Pkg.-5 pcs. 1 Pc. per card	OEM Bulk Pkg. 25 pcs.	Screw Size	Weight Ounces
Base Inches 1 1/2 x 5/8	769 DP CHR	769 000 CHR	8	6

Spare Keeper, Cat. No. 769 000 99A.
Spare Handle with Stud, Cat. No. 769 000 99C.



HATCH FASTENER OR WINDSHIELD KEEPER FIG. 697

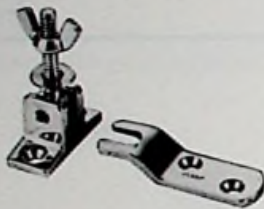

Fig. 697

Chrome Plated Brass and Zinc

ORDERING INFORMATION

Length Bolt Inches	Dimensions Bracket Inches	Dimensions Keeper Inches	Display Pkg.-10 pcs. 1 Pc. per card	Screw Size	Weight Ounces
1 1/2	1 1/2 x 5/8	1 1/2 x 3/4	697 DP CHR	8	3



HATCH FASTENER OR WINDSHIELD KEEPER FIG. 967



Fig. 967

Chrome Plated Bronze

ORDERING INFORMATION

Length Bolt Inches	Dimensions Bracket Inches	Dimensions Keeper Inches	Display Pkg.-5 pcs. 1 Pc. per card	Screw Size	Weight Ounces
1 1/2	1 9/16 x 1	1 7/8 x 7/8	967 DP CHR	8	6



HATCH FASTENER FIG. 770



Fig. 770

**Chrome Plated Bronze
Black Plastic Knob**

ORDERING INFORMATION

Dimensions Overall Inches	Adjustment Thread Inches	Display Pkg.-5 pcs. 1 Pc. per card	OEM Bulk Pkg. 25 pcs.	Screw Size	Weight Ounces
3 3/4 x 1 5/8	2 1/4	770 DP CHR	770 000 CHR	8	6



HOLD-DOWN CLAMP FIG. 1112

Chrome Plated Bronze

Flat Mounting



Fig. 1112

ORDERING INFORMATION

Length Inches	Width Inches	Display Pkg.-5 pcs. 1 Pc. per card	OEM Bulk Pkg. 25 pcs.	Screw Size	Weight Ounces
3	1 1/2	1112 DP CHR	1112 000 CHR	8	5 1/2



HOLD-DOWN CLAMP FIG. 1113

Chrome Plated Bronze

Angle Mounting



Fig. 1113

ORDERING INFORMATION

Length Inches	Width Inches	Display Pkg.-5 pcs. 1 Pc. per card	OEM Bulk Pkg. 25 pcs.	Screw Size	Weight Ounces
2 1/2	1 1/2	1113 DP CHR	1113 000 CHR	8	5 1/2



LOCKABLE HOLD-DOWN CLAMP FIG. 1108

Chrome Plated Bronze

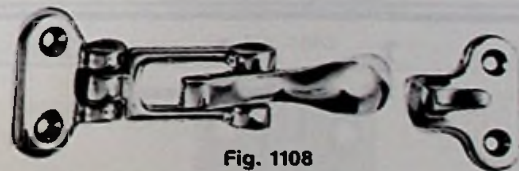

Fig. 1108

ORDERING INFORMATION

Dimensions Base Inches	Clearance Padlock Inches	Display Pkg.-5 pcs. 1 Pc. per card	OEM Bulk Pkg. 25 pcs.	Screw Size	Weight Ounces
2 3/4 x 1 3/4	1/4	1108 DP CHR	1108 000 CHR	6	4



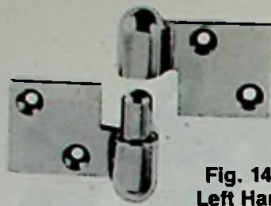

Fig. 149
Left Hand

PULL APART HINGES FIGS. 149 & 152

Chrome Plated Bronze

Fig. 149 — Left Hand
Fig. 152 — Right Hand

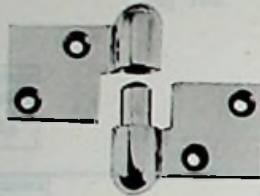

Fig. 152
Right Hand

Use 2 Left Hand or 2 Right Hand For Quick Removal of Hatches, Motor Covers, etc. or Together (1 each Left & Right) as a Heavy Duty Hinge.

ORDERING INFORMATION

Length Open Inches	Width Overall Inches	Display Pkg.-5 cds. 1 Pc. per card	OEM Pkg.-25 pcs.	Screw Size	Weight Ounces
3¾	2	149 DP CHR	149 000 CHR	10	5½
3¾	2	152 DP CHR	152 000 CHR	10	5½



Fig. 258 — Polished Stainless Steel

HATCH TRIM FIG. 258

Polished Stainless Steel

ORDERING INFORMATION

Width Inches	Length Overall Inches	Standard Pkg.-10 pcs.	Screw Size	Weight Pounds
1¼	72	258 002 STS	6	1
1½	72	258 004 STS	6	1½

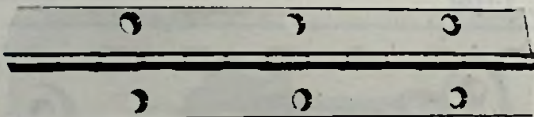

Fig. 212 — Polished Stainless Steel

CONTINUOUS HINGE FIG. 212

Polished Stainless Steel

Countersunk holes are two inches apart, center to center.

ORDERING INFORMATION

Width Open Inches	Length Overall Inches	Standard Pkg.-10 pcs.	Screw Size	Weight Pounds
1¼	72	212 002 STS	5	1½
1½	72	212 004 STS	5	2



BUTT HINGE FIG. 1002

**Heavy Gauge Extruded Brass
Chrome Plated
Fast Pin**

ORDERING INFORMATION

Height Pin Inches	Width Open Inches	Chrome Plated Brass Catalog No.	Std. Pkg. Prs.	Screw Size	No. of Holes	Weight per Pair Pounds
1½	1½	1002 002 CHR	5	6	4	¼
2	1½	1002 003 CHR	5	6	4	¼
2	2	1002 004 CHR	5	6	6	⅜
2½	2	1002 005 CHR	1	8	6	½
2½	2½	1002 006 CHR	1	8	6	⅝
3	2	1002 007 CHR	1	8	6	⅝
3	2½	1002 008 CHR	1	8	6	¾
3	3	1002 009 CHR	1	10	6	1¼
3½	2½	1002 010 CHR	1	10	6	⅞
3½	3	1002 011 CHR	1	10	6	1¼
4	3	1002 012 CHR	1	10	6	1½
4	4	1002 013 CHR	1	¼	6	1¾
5	4	1002 014 CHR	1	¼	8	2¼

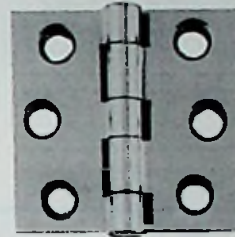
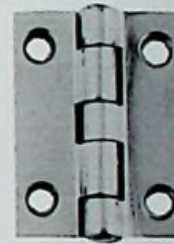

Fig. 1002



BUTT HINGE FIG. 1003

**Heavy Gauge Extruded Brass
Chrome Plated
Removable Pin**

ORDERING INFORMATION

Height Pin Inches	Width Open Inches	Chrome Plated Brass Catalog No.	Std. Pkg. Prs.	Screw Size	No. of Holes	Weight per Pair Pounds
1½	1½	1003 002 CHR	5	6	4	¼
2	1½	1003 003 CHR	5	6	4	¼
2	2	1003 004 CHR	5	6	6	⅜
2½	2	1003 005 CHR	1	8	6	½
2½	2½	1003 006 CHR	1	8	6	⅝
3	2	1003 007 CHR	1	8	6	⅝
3	2½	1003 008 CHR	1	8	6	¾
3	3	1003 009 CHR	1	10	6	1¼
3½	2½	1003 010 CHR	1	10	6	⅞
3½	3	1003 011 CHR	1	10	6	1¼
4	3	1003 012 CHR	1	10	6	1½
4	4	1003 013 CHR	1	¼	6	1¾
5	4	1003 014 CHR	1	¼	8	2¼

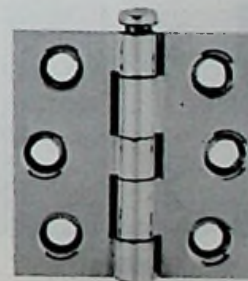
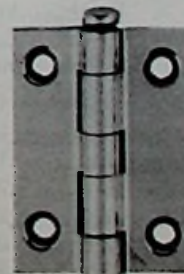

Fig. 1003



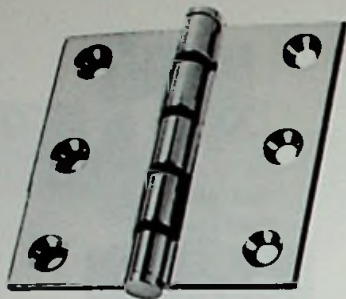

Fig. 1004



BUTT HINGE FIG. 1004

**Chrome Plated Extruded Brass
Extra Heavy Duty, Plastic Bearings
Removable Pin**

For Transom Doors and Other Applications Where Extra Strength Is Required.

ORDERING INFORMATION

Height Pin Inches	Width Open Inches	Standard Pkg.-1 pair	Screw Size	No. of Holes	Weight per Pair Pounds
4	4	1004 000 CHR	1/4	6	1 1/2

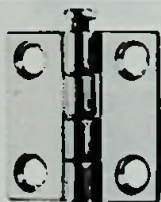
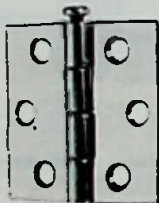

Fig. 1293



BUTT HINGE FIG. 1293

**Chrome Plated Zinc
Removable Pin**

ORDERING INFORMATION

Height Pin Inches	Width Open Inches	Display Pkg.-5 cds. 1 Pair per card	OEM Bulk Pkg. 25 pairs	Screw Size	No. of Holes	Weight per Pair Ounces
1 1/2	1 1/2	1293 DP2 CHR	-----	8	4	2
2	1 1/2	1293 DP3 CHR	-----	8	4	2 1/2
2	2	1293 DP4 CHR	*1293 004 CHR	8	4	3
2 1/2	2	1293 DP5 CHR	1293 005 CHR	8	6	4 1/2
2 1/2	2 1/2	1293 DP6 CHR	1293 006 CHR	8	6	5
3	3	1293 DP9 CHR	1293 009 CHR	10	6	7 1/2

*OEM Bulk Pkg.-50 pairs.

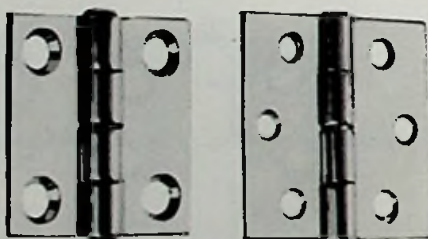

Fig. 949

BUTT HINGE FIG. 949

**Heavy Gauge Stamped Brass
Plain or Chrome Plated
Fast Pin**

ORDERING INFORMATION

Height Pin Inches	Width Open Inches	Chrome Plated Brass Display Pkg.-5 cds. 1 Pair per card	Chrome Plated Brass OEM Bulk Pkg. 25 pairs	Plain Brass Standard Pkg.-5 pairs	Screw Size	No. of Holes	Weight* per Pair Ounces
1 1/2	1 1/4	949 DP1 CHR	-----	949 001 PLB	6	4	2
1 1/2	1 1/2	949 DP2 CHR	-----	949 002 PLB	6	4	2 1/2
2	1 1/2	949 DP3 CHR	-----	949 003 PLB	6	4	2 3/4
2	2	949 DP4 CHR	949 004 CHR	949 004 PLB	6	6	4
2 1/2	2	949 DP5 CHR	949 005 CHR	*949 005 PLB	8	6	5
2 1/2	2 1/2	949 DP6 CHR	949 006 CHR	*949 006 PLB	8	6	6 3/4
3	3	949 DP9 CHR	949 009 CHR	*949 009 PLB	10	6	9 1/2

*Standard Pkg.-1 pair.



BUTT HINGE FIG. 952

Heavy Gauge Stamped Brass
Plain or Chrome Plated
Removable Pin

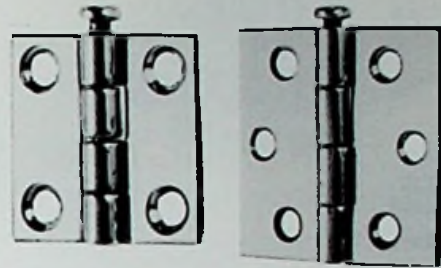

Fig. 952

ORDERING INFORMATION

Height Pin Inches	Width Open Inches	Chrome Plated Brass	Chrome Plated Brass	Plain Brass	Screw Size	No. of Holes	Weight per Pair Ounces
		Display Pkg.-5 cds. 1 Pair per card	OEM Bulk Pkg. 25 pairs	Standard Pkg.-5 pairs			
1 1/2	1 1/4	952 DP1 CHR	-----	952 001 PLB	6	4	2
1 1/2	1 1/2	952 DP2 CHR	-----	952 002 PLB	6	4	2 1/2
2	1 1/2	952 DP3 CHR	-----	952 003 PLB	6	4	2 3/4
2	2	952 DP4 CHR	952 004 CHR	952 004 PLB	6	6	4
2 1/2	2	952 DP5 CHR	952 005 CHR	*952 005 PLB	8	6	5
2 1/2	2 1/2	952 DP6 CHR	-----	**952 006 PLB	8	6	6 3/4
3	3	952 DP9 CHR	952 009 CHR	**952 009 PLB	10	6	9 1/2

*Standard Pkg.-1 pair.

**Standard Pkg.-1 pair, O.E.M. Bulk Pkg.-25 pairs.



HINGE FIG. 773

Chrome Plated Bronze
Removable Pin



Fig. 773

ORDERING INFORMATION

Length Overall Inches	Width Overall Inches	Display Pkg.-5 cds. 1 Pair per card	Screw Size	Weight per Pair Ounces
3 1/8	2 5/8	773 DP CHR	10	1 5/8



HINGE FIG. 951

Chrome Plated Bronze



Fig. 951

ORDERING INFORMATION

Length Open Inches	Width Overall Inches	Display Pkg.-5 cds. 1 Pair per card	OEM Bulk Pkg. 25 pairs	Screw Size	Weight per Pair Ounces
3	1 1/2	951 DP1 CHR	951 001 CHR	8	3 1/2
4	1 1/2	951 DP2 CHR	951 002 CHR	8	5 1/2



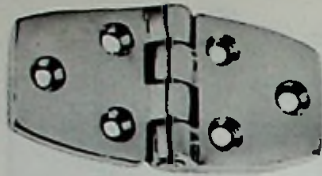

Fig. 808



HINGE FIG. 808

Chrome Plated Zinc

ORDERING INFORMATION

Length Open Inches	Width Overall Inches	Display Pkg.-10 cds. 1 Pair per card	OEM Bulk Pkg. 50 pairs	Screw Size	Weight per Pair Ounces
3	1 1/2	808 DP CHR	808 000 CHR	8	3 1/2

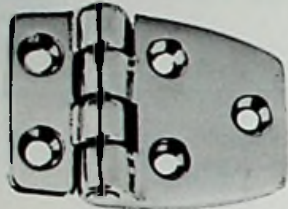

Fig. 987
Chrome Plated Bronze
Fig. 1213
Chrome Plated Zinc



SHORTSIDE HINGES FIGS. 987 & 1213

Fig. 987 — Chrome Plated Bronze
Fig. 1213 — Chrome Plated Zinc

ORDERING INFORMATION

Length Open Inches	Width Overall Inches	Length Shortside Inches	Display Pkg.-5 cds. 1 Pair per card	OEM Bulk Pkg. 50 pairs	Screw Size	Weight per Pair Ounces
2 1/4	1 1/2	3/4	987 DP1 CHR	987 001 CHR	8	3 1/2
2 3/4	1 1/2	3/4	987 DP2 CHR	-----	8	4
2 1/2	1 1/2	3/4	1213 DP1 CHR	1213 001 CHR	8	3

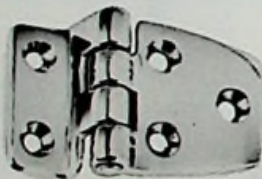

Fig. 988
Chrome Plated Bronze
Fig. 1214
Chrome Plated Zinc



OFFSET SHORTSIDE HINGES FIGS. 988 & 1214

Fig. 988 — Chrome Plated Bronze
Fig. 1214 — Chrome Plated Zinc

ORDERING INFORMATION

Length Open Inches	Width Overall Inches	Length Shortside Inches	Offset Inches	Display Pkg.-5 cds. 1 Pair per card	OEM Bulk Pkg. 50 Pairs	Screw Size	Weight per Pair Ounces
2 1/4	1 1/2	3/4	3/8	988 DP1 CHR	988 001 CHR	8	4
2 3/4	1 1/2	3/4	3/8	988 DP2 CHR	-----	8	5
2 1/2	1 1/2	3/4	3/8	1214 DP1 CHR	1214 001 CHR	8	4



Fig. 999

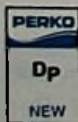

SHORTSIDE HINGE FIG. 999

Chrome Plated Bronze

ORDERING INFORMATION

Length Open Inches	Width Overall Inches	Length Shortside Inches	Display Pkg.-5 cds. 1 Pair per card	OEM Bulk Pkg. 25 pairs	Screw Size	Weight per Pair Ounces
3 1/2	1 1/2	1 1/2	999 DP CHR	999 000 CHR	8	5

OFFSET HINGE FIG. 942

Chrome Plated Zinc

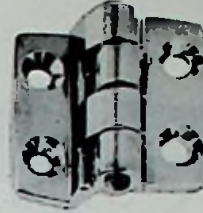

Fig. 942



Length Open Inches	Width Overall Inches	Offset Inches	ORDERING INFORMATION		Screw Size	Weight per Pair Ounces
1 1/2	1 1/2	3/8	Display Pkg.-5 cds. 1 Pair per card	OEM Bulk Pkg. 50 pairs	8	2 1/2
			942 DP CHR	942 000 CHR		

BUTT HINGE FIG. 941

Chrome Plated Zinc

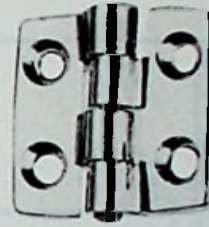
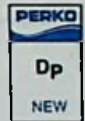

Fig. 941



Length Open Inches	Width Overall Inches	ORDERING INFORMATION		Screw Size	Weight per Pair Ounces
1 1/2	1 1/2	Display Pkg.-5 cds. 1 Pair per card	OEM Bulk Pkg. 50 pairs	8	2 1/2
		941 DP CHR	941 000 CHR		

INSET HINGE FIG. 271

Semi-Concealed
For Inset Doors

Chrome Plated
Stamped Brass

3/8 Inch Inset

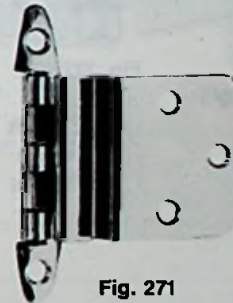

Fig. 271



Dimensions Inches	ORDERING INFORMATION		Screw Size	Weight per Pair Ounces
2 3/4 x 2 1/8	Display Pkg.-10 cds 1 Pair per card	OEM Bulk Pkg. 100 Pairs	4	2 1/2
	271 DP CHR	271 000 CHR		

FLUSH HINGE FIG. 272

Semi-Concealed
For Overlay Doors

Chrome Plated
Stamped Brass

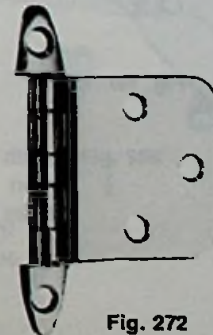

Fig. 272



Dimensions Inches	ORDERING INFORMATION		Screw Size	Weight per Pair Ounces
2 3/4 x 2 1/8	Display Pkg.-10 cds 1 Pair per card	OEM Bulk Pkg. 100 Pairs	4	2 1/2
	272 DP CHR	272 000 CHR		

STRAP HINGE FIG. 120



Fig. 120

Chrome Plated Bronze

Length Open Inches	Width Pin Inches	ORDERING INFORMATION			Screw Size	No. of Holes	Weight per Pair Ounces
		Display Pkg.-5 cds. 1 Pair per card	OEM Bulk Pkg. 25 pairs				
4	1 1/8	120 DP1 CHR	120 001 CHR	10	4	6	
6	1 1/8	120 DP2 CHR	120 002 CHR	10	6	8	
8	1 3/8	120 DP3 CHR	120 003 CHR	12	6	16	



SHORTSIDE STRAP HINGE FIG. 122



Fig. 122

Chrome Plated Bronze

Length Open Inches	Width Pin Inches	Length Shortside Inches	ORDERING INFORMATION			Screw Size	No. of Holes	Weight per Pair Ounces
			Display Pkg.-5 cds. 1 Pair per card	OEM Bulk Pkg. 25 pairs				
4 7/8	1 1/8	2 1/16	122 DP CHR	122 000 CHR	10	5	7	

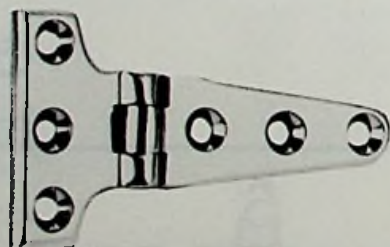
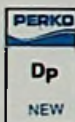
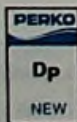

Fig. 197

"T" HINGE FIG. 197

Chrome Plated Bronze

Length Open Inches	Width Overall Inches	Length "T" Side Inches	ORDERING INFORMATION			Screw Size	No. of Holes	Weight per Pair Ounces
			Display Pkg.-5 cds. 1 Pair per card	OEM Bulk Pkg. 10 Pairs				
4	2 1/8	1 5/16	197 DP1 CHR	197 001 CHR	10	6	8	
6	3	1 1/2	197 DP2 CHR	197 002 CHR	10	7	16	
8	3 7/8	2	197 DP3 CHR	197 003 CHR	12	8	25	



HINGE FIG. 924

Chrome Plated Stamped Brass

ORDERING INFORMATION

Length Open Inches	Width Overall Inches	Display Pkg.-10 cds. 1 Pair per card	Screw Size	Weight per Pair Ounces
3	1 1/2	924 DP CHR	6	2 1/2

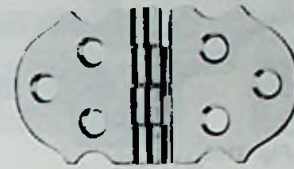

Fig. 924



NON-MORTISED HINGE FIG. 957

**Stamped Brass
Plain or Chrome Plated**

Easily Installs Without Mortising.

ORDERING INFORMATION

Finish	Height Pin Inches	Width Closed Inches	Display Pkg.-5 cds. 1 Pair per card	Standard Pkg.-5 pairs	OEM Bulk Pkg. 50 Pairs	Weight per Pair Ounces
	Plain	3 3/8	7/8	-----	957 000 PLB	957 000 PLB
Chrome	3 3/8	7/8	957 DP CHR	-----	957 000 CHR	4

Fig. 957

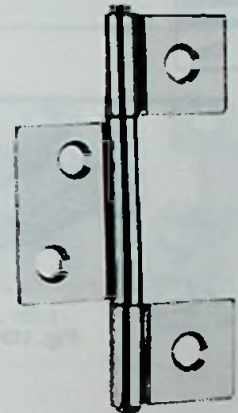

Screw Size # 8.



HASP FIG. 998

Chrome Plated Bronze

ORDERING INFORMATION

Length Closed Inches	Width Overall Inches	Padlock Clearance Inches	Display Pkg.-10 cds. 1 Pc. per card	OEM Bulk Pkg. 25 Pcs.	Screw Size	Weight Ounces
2	1	9/32	998 DP1 CHR	998 001 CHR	6	2
3	1	9/32	998 DP2 CHR	998 002 CHR	6	3

Fig. 998



Spare Plain Keepers (2 per card), Cat. No. 959 DP PLB.
Spare Chrome Keepers (2 per card), Cat. No. 959 DP CHR.





Fig. 1198

HASP FIG. 1198

Chrome Plated Zinc

ORDERING INFORMATION

Length Closed Inches	Width Inches	Padlock Clearance Inches	Display Pkg.-10 pcs. 1 Pc. per card	OEM Bulk Pkg. 25 pcs.	Screw Size	Weight Ounces
2	1	1/4	1198 DP1 CHR	1198 001 CHR	6	1 1/2
3	1	1/4	1198 DP2 CHR	1198 002 CHR	6	2 1/4
3 3/4	1	1/4	1198 DP3 CHR	1198 003 CHR	6	2 1/2



Spare Keepers (2 per card), Cat. No. 1261 DP CHR.

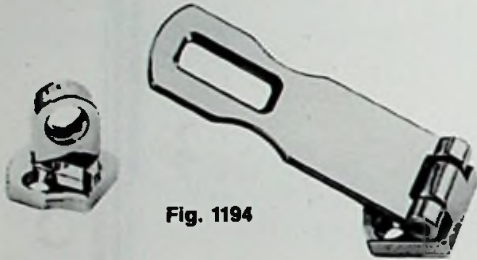

Fig. 1194

SWIVEL EYE HASP FIG. 1194

Chrome Plated Zinc

Padlock Eye Swivels to Act as a Latch.

ORDERING INFORMATION

Length Closed Inches	Width Inches	Padlock Clearance Inches	Display Pkg.-10 pcs. 1 Pc. per card	OEM Bulk Pkg. 100 pcs.	Screw Size	Weight Ounces
3	1	1 1/32	1194 DP CHR	1194 000 CHR	6	2 1/2



Spare Keeper, Cat. No. 1194 DP 99A.

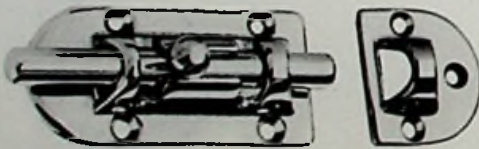

Fig. 947

BARREL BOLT FIG. 947

Cast Bronze
Plain or Chrome Plated

Supplied with Friction Pad to Eliminate Rattle and Provide Smooth Operation.

ORDERING INFORMATION

Dimensions Overall Inches	Chrome Plated Bronze Display Pkg.-5 pcs. 1 Pc. per card	Chrome Plated Bronze OEM Bulk Pkg. 25 pcs.	Plain Bronze Std. Pkg.-5 pcs. OEM Pkg.-25 pcs.	Screw Size	Weight Ounces
3 7/16 x 1 7/16	947 DP1 CHR	947 001 CHR	947 001 PLB	6	4
4 5/16 x 1 7/16	947 DP2 CHR	947 002 CHR	947 002 PLB	6	4
5 1/4 x 1 7/16	947 DP3 CHR	947 003 CHR	*947 003 PLB	6	5



* No O.E.M. Bulk Pkg. Available.

BARREL BOLT FIG. 1244

Chrome Plated Zinc

Integral Friction Pad Eliminates Rattle and Provides Smooth Operation.



Fig. 1244

ORDERING INFORMATION

Dimensions	Display Pkg. -5 pcs.	OEM Bulk Pkg.	Screw Size	Weight Ounces
Overall Inches	1 Pc. per card	25 pcs.	6	3
3 3/8 x 1 1/4	1244 DP CHR	1244 000 CHR		



SHIP BOLT FIG. 1053

Chrome Plated Bronze

Supplied with Brass Friction Spring to Eliminate Rattle and Provide Smooth Operation.

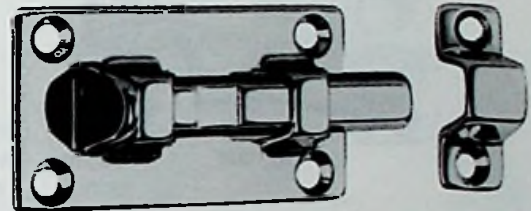

Fig. 1053

ORDERING INFORMATION

Dimensions	Display Pkg. -5 pcs.	OEM Bulk Pkg.	Screw Size	Weight Ounces
Overall Inches	1 Pc. per card	25 pcs.	6	1 3/4
2 5/8 x 1 1/4	1053 DP CHR	1053 000 CHR		



CABIN DOOR HOOK FIG. 956

Cast Bronze
Plain or Chrome Plated

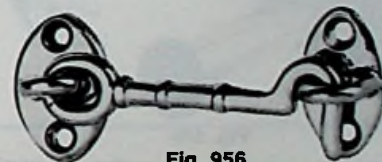

Fig. 956

ORDERING INFORMATION

Length Hook Inches	Chrome Plated Bronze	Chrome Plated Bronze	Plain Bronze	Weight Ounces
	Display Pkg. -5 pcs. 1 Pc. per card	OEM Bulk Pkg. 50 pcs.	Standard Pkg. -5 pcs.	
1 1/2	956 DP1 CHR	956 001 CHR	956 001 PLB	1
2	956 DP2 CHR	956 002 CHR	956 002 PLB	1 1/2
2 1/2	956 DP3 CHR	956 003 CHR	956 003 PLB	1 3/4
3	956 DP4 CHR	956 004 CHR	956 004 PLB	2
3 1/2	956 DP5 CHR	-----	956 005 PLB	2 1/2
4	956 DP6 CHR	-----	956 006 PLB	3
5	956 DP7 CHR	-----	956 007 PLB	3 1/2
6	956 DP8 CHR	*956 008 CHR	956 008 PLB	5

*O.E.M. Bulk Pkg. -25 pcs.

Screw Size #6.

Spare Plain Keepers (2 per card), Cat. No. 959 DP PLB.

Spare Chrome Keepers (2 per card), Cat. No. 959 DP CHR.



CABIN DOOR HOOK FIG. 1199

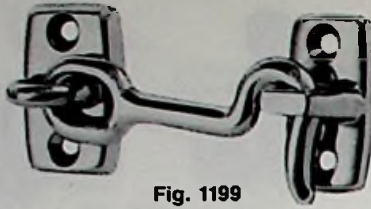

Fig. 1199

Chrome Plated Zinc

ORDERING INFORMATION

Length Hook Inches	Display Pkg.-20 pcs. 1 Pc. per card	OEM Bulk Pkg. 50 pcs.	Screw Size	Weight Ounces
1 3/4	1199 DP1 CHR	1199 001 CHR	6	1 1/4
2 1/4	1199 DP2 CHR	1199 002 CHR	6	1 3/8
3	1199 DP3 CHR	1199 003 CHR	6	1 1/2
4	1199 DP4 CHR	1199 004 CHR	6	1 3/4

Spare Keepers (2 per card), Cat. No. 1261 DP CHR.



CABIN DOOR HOOK FIG. 1287

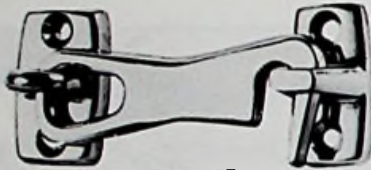

Fig. 1287

Chrome Plated Zinc

Patent No. 197,531

ORDERING INFORMATION

Length Hook Inches	Display Pkg.-20 pcs. 1 Pc. per card	OEM Bulk Pkg. 50 pcs.	Screw Size	Weight Ounces
2	1287 DP1 CHR	1287 001 CHR	6	1 1/4
2 1/2	1287 DP2 CHR	1287 002 CHR	6	1 1/2
3	1287 DP3 CHR	1287 003 CHR	6	1 3/4

Spare Keepers (2 per card), Cat. No. 1261 DP CHR.



DOOR STOP AND HOLDER FIG. 574



Fig. 574

Chrome Plated Bronze
Rubber Bumper

ORDERING INFORMATION

Length Inches	O.D. Inches	Display Pkg.-5 pcs. 1 Pc. per card	OEM Bulk Pkg. 25 pcs.	Stop Screw Size	Keeper Screw Size	Weight Ounces
2 3/8	1 3/4	574 DP1 CHR	574 001 CHR	8	6	4 1/2
3 1/4	1 3/4	574 DP2 CHR	574 002 CHR	8	6	5 1/2



DOOR STOP FIG. 1177



Fig. 1177

Chrome Plated Zinc
Rubber Bumper

ORDERING INFORMATION

Length Inches	O.D. Inches	Display Pkg.-5 pcs. 1 Pc. per card	OEM Bulk Pkg. 50 pcs.	Screw Size	Weight Ounces
1	1 1/4	1177 DP CHR	1177 000 CHR	4	1



DOOR HOLDER FIG. 1065

**Stainless Steel Clip
Chrome Plated Zinc Arrow**

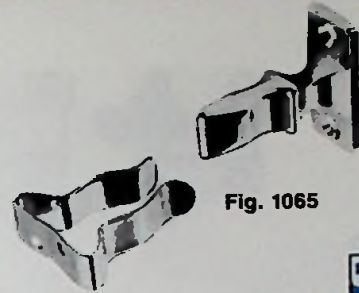

Fig. 1065

ORDERING INFORMATION

Dimensions Arrow Base Inches	Dimensions Clip Base Inches	Projection Inches	Display Pkg.-5 pcs. 1 Pc. per card	Screw Size	Weight Ounces
1 5/8 x 3/4	1 3/8 x 7/16	1 3/4	1065 DP CHR	8	2



DOOR CATCH FIG. 554

White Plastic

**Stainless Steel Spring
Chrome Plated Brass Screw**

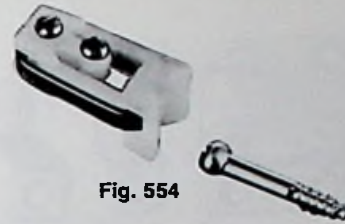

Fig. 554

ORDERING INFORMATION

Screw Size Inches	Dimensions Catch Inches	Display Pkg.-25 cds. 2 Pcs. per card	OEM Bulk Pkg. 100 pcs.	Mounting Screw Size	Weight per 50 Ounces
3/4 x #8	1 1/4 x 5/8	554 DP	554	4 R.H.	4



DOOR CATCH FIG. 559

Black Plastic



Fig. 559

ORDERING INFORMATION

Dimensions Stud Inches	Dimensions Catch Inches	Display Pkg.-25 cds. 2 Pcs. per card	OEM Bulk Pkg. 100 pcs.	Screw Size	Weight per 50 Ounces
1 1/8 x 3/8	1 3/8 x 7/8	559 DP	559	4 R.H.	4



DOOR BUTTONS FIGS. 1216 & 1217

**Chrome Plated Zinc
Black Plastic Knob**



Figs. 1216 & 1217

**Fig. 1216 — Supplied with Phosphor Bronze Tension Spring.
Fig. 1217 — Supplied without Spring and Requires a
No. 8 Oval-Head Pivot Screw.**

ORDERING INFORMATION

O.D. Overall Inches	Display Pkg.-10 pcs. 1 Pc. per card	OEM Bulk Pkg. 50 pcs.	Screw Size	Weight Ounces
1 3/4	1216 DP CHR	1216 000 CHR	6	1 1/2
1 3/4	1217 DP CHR	1217 000 CHR	6	1 1/2

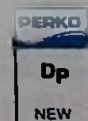

Spare Knob for Both, Cat. No. 1216 000 99A.

CUPBOARD BOLT FIG. 1101

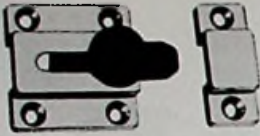

Fig. 1101



**Chrome Plated Zinc
Black Plastic Slide and Knob**

ORDERING INFORMATION

Dimensions	Display Pkg.-5 pcs.	OEM Bulk Pkg.	Screw Size	Weight Ounces
Overall Inches	1 Pc. per card	50 pcs.		
2 1/8 x 1 1/2	1101 DP CHR	1101 000 CHR	6	2

CUPBOARD CATCH FIG. 1102

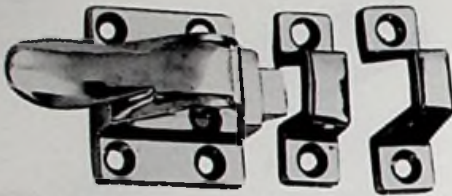

Fig. 1102



Chrome Plated Zinc

**No. 1 Supplied with Box Strike
No. 2 Supplied with 3/8 Inch Offset Box Strike**

ORDERING INFORMATION

Dimensions	Display Pkg.-5 pcs.	OEM Bulk Pkg.	Screw Size	Weight Ounces
Overall Inches	1 Pc. per card	50 pcs.		
1 1/2 x 1 7/8	1102 DP1 CHR	1102 001 CHR	6	3 1/2
1 1/2 x 1 7/8	1102 DP2 CHR	1102 002 CHR	6	3 1/2

CUPBOARD TURN FIG. 978

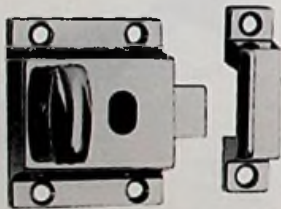

Fig. 978



Chrome Plated Zinc

ORDERING INFORMATION

Dimensions	Display Pkg.-5 pcs.	Screw Size	Weight Ounces
Overall Inches	1 Pc. per card		
2 1/8 x 2 1/4	978 DP CHR	6	5

Spare Strike Plate, Cat. No. 976 000 CHR.
Spare Bevel with Cam, Cat. No. 984 000 CHR.

CUPBOARD TURN FIG. 986

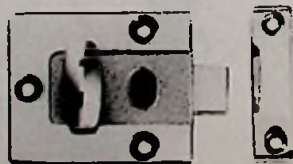

Fig. 986



Chrome Plated Zinc

ORDERING INFORMATION

Dimensions	Display Pkg.-5 pcs.	Screw Size	Weight Ounces
Overall Inches	1 Pc. per card		
2 x 2 1/4	986 DP CHR	8	5

Spare Strike Plate, Cat. No. 977 000 CHR.
Spare Bevel with Cam, Cat. No. 984 000 CHR.

LATCH FIG. 948

Chrome Plated Zinc

Sliding Lock Button

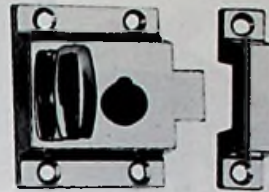

Fig. 948

ORDERING INFORMATION

Dimensions			
Overall Inches	Display Pkg.-5 pcs. 1 Pc. per card	Screw Size	Weight Ounces
2 1/8 x 2 1/4	948 DP CHR	6	5

Spare Strike Plate, Cat. No. 976 000 CHR.
Spare Bevel with Cam, Cat. No. 984 000 CHR.



LATCH FIG. 983

Chrome Plated Zinc

Sliding Lock Button

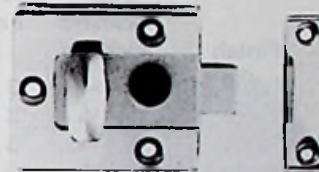

Fig. 983

ORDERING INFORMATION

Dimensions			
Overall Inches	Display Pkg.-5 pcs. 1 Pc. per card	Screw Size	Weight Ounces
2 x 2 1/4	983 DP CHR	8	5

Spare Strike Plate, Cat. No. 977 000 CHR.
Spare Bevel with Cam, Cat. No. 984 000 CHR.



FLUSH LOCK & LATCH FIGS. 921 & 922

Chrome Plated Zinc

Fig. 921 — Locking Latch with 2 Keys

Fig. 922 — Non-Locking Latch

Easily Installs in a 1 5/8 Inch Diameter Hole:

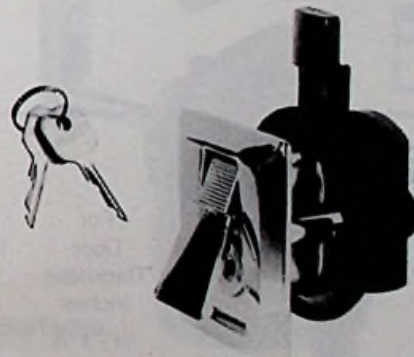

Fig. 921

ORDERING INFORMATION				
For Door Thickness Inches	Dimensions Face Plate Inches	Display Pkg.-5 pcs. 1 Pc. per card	OEM Bulk Pkg. 25 pcs.	Weight Ounces
1/2 - 3/4	2 1/4 x 2	921 DP CHR	921 000 CHR	6 1/2
1/2 - 3/4	2 1/4 x 2	922 DP CHR	922 000 CHR	6

Spare Cam Bar, Cat. No. 980





FLUSH LOCK & LATCH FIGS. 1031 & 1032

Chrome Plated Zinc, Black or White Plastic
With Stainless Steel Stem and Lock Nut.

Large Handle Allows Two Finger Grip.

Fig. 1031 — Locking Latch with 2 Keys
Fig. 1032 — Non-Locking Latch

Flush Mounts in a 2 3/8 x 2 3/8 Inch Hole.
Surface Mounts in a 1 5/8 Inch Diameter Hole
With Plastic Spacer Included.

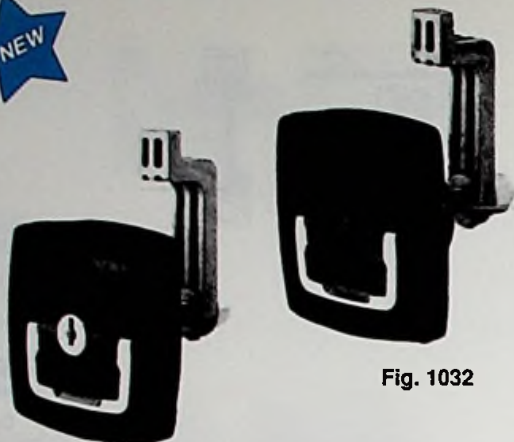

Fig. 1032



Fig. 1031



Finish	For Door Thickness Inches	Dimensions Face Plate Inches	Adjustment Latch Bar Inches	ORDERING INFORMATION		
				Display Pkg.-5 pcs. 1 Pc. per card	OEM Bulk Pkg. 25 pcs.	Weight Ounces
Black	1/8 - 3/4	3 1/8 x 3 1/8	1/2 - 3	1031 DP1 BLK	1031 001 BLK	10
White	1/8 - 3/4	3 1/8 x 3 1/8	1/2 - 3	1031 DP1 WHT	1031 001 WHT	10
Black	1/8 - 3/4	3 1/8 x 3 1/8	1/2 - 3	1032 DP1 BLK	1032 001 BLK	10
White	1/8 - 3/4	3 1/8 x 3 1/8	1/2 - 3	1032 DP1 WHT	1032 001 WHT	10



FLUSH LOCK & LATCH FIGS. 931 & 932

Chrome Plated Zinc, Black or White Plastic
With Stainless Steel Stem and Lock Nut.

Fig. 931 — Locking Latch with 2 Keys
Fig. 932 — Non-Locking Latch

No. 1 with Flush Cam Bar and Flexible Plastic Strike Plate.
No. 2 with Offset Adjustable Cam Bar.

Detents Indicate Open or Closed Position.
Easily Installs in a 2 Inch Diameter Hole.

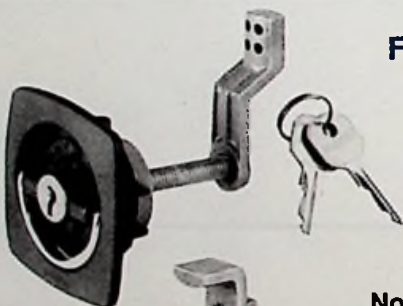

Cat. No. 931 001 BLK



Cat. No. 932 002 BLK



Flexible Plastic Strike

Finish	For Door Thickness Inches	Dimensions Face Plate Inches	Adjustment Latch Bar Inches	ORDERING INFORMATION		
				Display Pkg.-5 pcs. 1 Pc. per card	OEM Bulk Pkg. 25 pcs.	Weight Ounces
Black	1/4 - 1 1/8	2 1/2 x 2 1/2	3/8 - 3	931 DP1 BLK	931 001 BLK	8
White	1/4 - 1 1/8	2 1/2 x 2 1/2	3/8 - 3	931 DP1 WHT	931 001 WHT	8
Black	1/4 - 1 1/8	2 1/2 x 2 1/2	3/8 - 3	931 DP2 BLK	931 002 BLK	8 1/2
White	1/4 - 1 1/8	2 1/2 x 2 1/2	3/8 - 3	931 DP2 WHT	931 002 WHT	8 1/2
Black	1/4 - 1 1/8	2 1/2 x 2 1/2	3/8 - 3	932 DP1 BLK	932 001 BLK	7
White	1/4 - 1 1/8	2 1/2 x 2 1/2	3/8 - 3	932 DP1 WHT	932 001 WHT	7
Black	1/4 - 1 1/8	2 1/2 x 2 1/2	3/8 - 3	932 DP2 BLK	932 002 BLK	7 1/2
White	1/4 - 1 1/8	2 1/2 x 2 1/2	3/8 - 3	932 DP2 WHT	932 002 WHT	7 1/2



Spare Flush Cam Bar, Cat. No. 931 001 99A.
Spare Offset Adjustable Cam Bar, Cat. No. 931 002 99A.

FLUSH HATCH DOG FIG. 777

**Chrome Plated Brass
Stainless Steel Lock Nuts
With Flush Strike**

For Securely Fastening "Dogging" Deck Hatches.

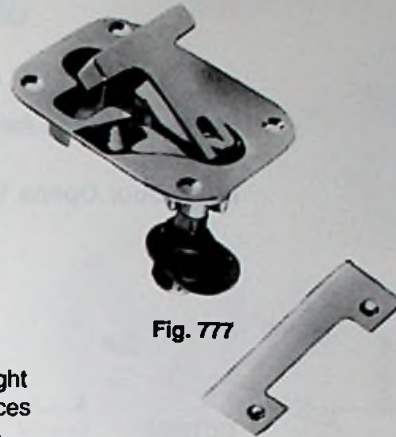

Fig. 777

ORDERING INFORMATION

For	Dimensions	Adjustment	Std. Pkg.-1 pc.	Screw	Weight
Max. Hatch Thickness Inches	Face Plate Inches	Latch Bar Inches	OEM Pkg.-5 pcs.	Size	Ounces
2	3 13/16 x 3	1 1/4 - 2	777 000 CHR	8	14

LOCK & LATCH COVER FIG. 1089

**Black or White
Fiber Reinforced Plastic
Hinged, Water Resistant**

**No. 1 — Fits Figs. 931 and 932
No. 3 — Fits Figs. 1031 and 1032**



Fig. 1089

ORDERING INFORMATION

Finish	Dimensions	Display Pkg.-5 pcs.	OEM Bulk Pkg.	Weight
	Overall Inches	1 Pc. per card	25 pcs.	Ounces
Black	2 3/4 x 3 1/4	1089 DP1 BLK	1089 001 BLK	2
White	2 3/4 x 3 1/4	1089 DP1 WHT	1089 001 WHT	2
Black	3 1/4 x 3 3/4	1089 DP3 BLK	1089 003 BLK	3
White	3 1/4 x 3 3/4	1089 DP3 WHT	1089 003 WHT	3



TRIM RINGS FIGS. 1024 & 1025

**Chrome Plated Zinc
Designed for Use with Figs. 931 and 932**

**Fig. 1024 — Has Gripper Teeth on the Under Side for Carpeted Surfaces.
Fig. 1025 — Has a Flat Under Side for Smooth Surfaces.**



**Flush Lock
Not
Included**



Fig. 1025

ORDERING INFORMATION

Dimensions	Std. Pkg.-5 pcs.	Weight
Overall Inches	OEM Pkg.-25 pcs.	Ounces
2 7/8 x 2 7/8	1024 000 CHR	2
2 7/8 x 2 7/8	1025 000 CHR	2

DETERMINING THE BEVEL REQUIRED ON A LOCK OR LATCH.

When Standing Outside

If the Door Opens Away From You, Then You Need a Lock or Latch with a Regular Bevel.

If the Door Opens Toward You, Then You Need a Lock or Latch with a Reverse Bevel.

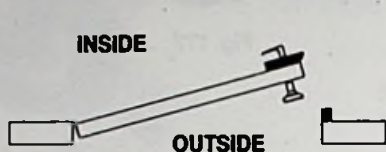

Right Hand Door Showing Regular Bevel Lock With Interchangeable Knob and Lever.

Door Opening Inward.

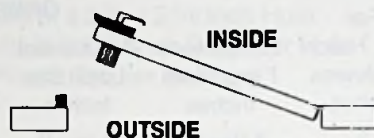

Left Hand Door Showing Regular Bevel Lock With Non-Interchangeable Knob and Lever.

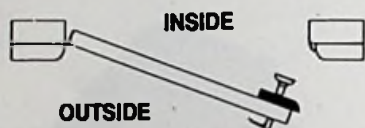

Right Hand Door Showing Reverse Bevel Lock With Interchangeable Knob and Lever.

Door Opening Outward.

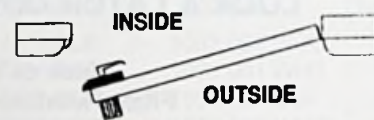

Left Hand Door Showing Reverse Bevel Lock With Non-Interchangeable Knob and Lever.

All PERKO Lock and Latch Sets May Be Used On Either Right or Left Hand Doors.

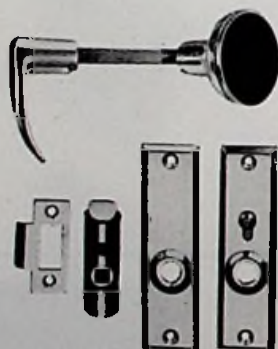

Fig. 567

TUBULAR LATCH SET

FIG. 567

Chrome Plated Zinc

Sliding Lock Button

For Door Thickness Inches	Dimensions Escutcheon Inches	O.D. Tube Inches	ORDERING INFORMATION			
1-1 3/8	4 3/8 x 1 1/4	3/4	Display Pkg.-5 cds. 1 Set per card	OEM Bulk Pkg. 10 sets	Screw Size 6	Weight Pounds 3/4
			567 DP CHR	567 000 CHR		

Spare Flush Strike, Cat. No. 912 000 CHR.
Spare Knob and Handle Assembly, Cat. No. 962 000 CHR.



FLUSH CUP RIM LATCH SETS FIGS. 1239 & 1240

Chrome Plated Zinc

Sliding Lock Button

Fig. 1239 — Regular Bevel with Box Strike

Fig. 1240 — Reverse Bevel with Flush Strike

Supplied with Black Plastic Spacer For Surface Mounting.

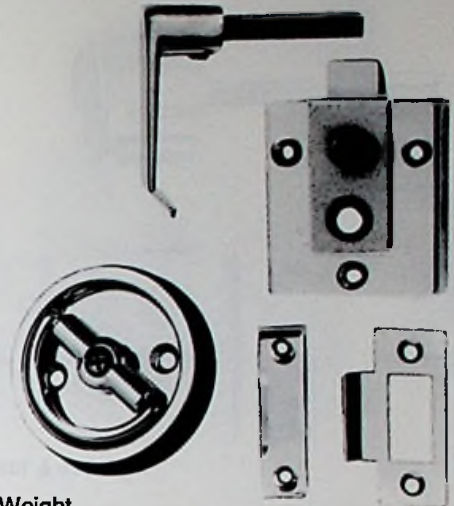

Fig. 1239 Fig. 1240

For Door Thickness Inches	Dimensions Case Inches	O.D. Cup Inches	ORDERING INFORMATION		
			Display Pkg.-5 sets 1 Set per pkg.	OEM Bulk Pkg. 10 sets	Weight Pounds
5/8-1	2 x 2 1/4	2 1/4	1239 DP CHR	1239 000 CHR	1
5/8-1	2 x 2 1/4	2 1/4	1240 DP CHR	1240 000 CHR	1

Case and Cup Both, Screw Size #8.

Spare Box Strike, Cat. No. 977 000 CHR.
Spare Flush Strike, Cat. No. 912 000 CHR.

Spare Regular Bevel with Cam, Cat. No. 984 000 CHR.
Spare Reverse Bevel with Cam, Cat. No. 920 000 CHR.

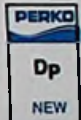

MORTISE LATCH SETS

FIGS. 991 & 992

Chrome Plated Zinc

Sliding Lock Button

Fig. 991 — Regular Bevel with Flush Strike

Fig. 992 — Reverse Bevel with Flush Strike

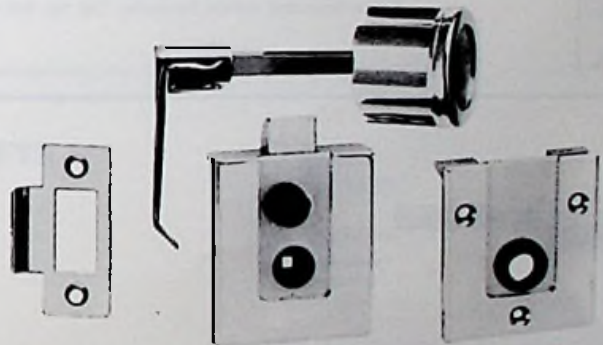

Fig. 992

For Door Thickness Inches	Dimensions Case Inches	Dimensions Escutcheon Inches	ORDERING INFORMATION			
			Display Pkg.-5 sets 1 Set per card	OEM Bulk Pkg. 10 sets	Screw Size	Weight Pounds
1/2 - 3/4	1 5/8 x 1 5/8	2 x 2 1/4	991 DP CHR	991 000 CHR	6	1
1/2 - 3/4	1 5/8 x 1 5/8	2 x 2 1/4	992 DP CHR	992 000 CHR	6	1

Spare Flush Strike, Cat. No. 912 000 CHR.
Spare Knob and Handle Assembly, Cat. No. 995 000 CHR.

Spare Regular Bevel with Cam, Cat. No. 984 000 CHR.
Spare Reverse Bevel with Cam, Cat. No. 920 000 CHR.



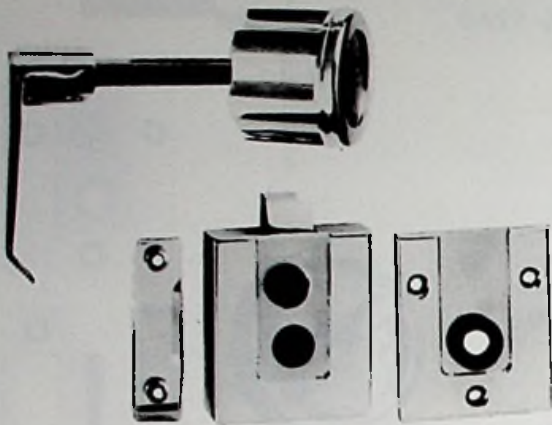

Figs. 929 & 1029

RIM LATCH SETS

FIGS. 929 & 1029

Chrome Plated Zinc

Sliding Lock Button

Fig. 929 — Regular Bevel with Box Strike

Fig. 1029 — Reverse Bevel with Box Strike

For Door Thickness Inches	Dimensions Case Inches	Dimensions Escutcheon Inches
1/2 - 1	2 x 2 1/4	2 x 2 1/4
1/2 - 1	2 x 2 1/4	2 x 2 1/4

ORDERING INFORMATION

Display Pkg.-5 sets 1 Set per pkg.	OEM Bulk Pkg. 10 sets	Screw Size	Weight Pounds
929 DP CHR	929 000 CHR	6	3/4
1029 DP CHR	1029 000 CHR	6	3/4

Spare Box Strike, Cat. No. 977 000 CHR.
Spare Knob and Handle Assembly, Cat. No. 995 000 CHR.

Spare Regular Bevel with Cam, Cat. No. 984 000 CHR.
Spare Reverse Bevel with Cam, Cat. No. 920 000 CHR.

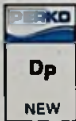

Dp
NEW

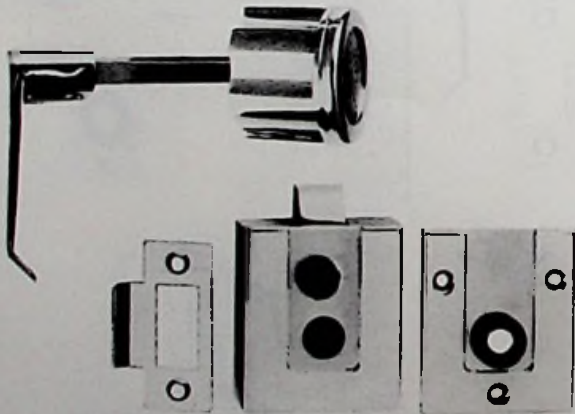

Fig. 968 & 1068

RIM LATCH SETS

FIGS. 968 & 1068

Chrome Plated Zinc

Sliding Lock Button

Fig. 968 — Regular Bevel with Flush Strike

Fig. 1068 — Reverse Bevel with Flush Strike

For Door Thickness Inches	Dimensions Case Inches	Dimensions Escutcheon Inches
1/2 - 1	2 x 2 1/4	2 x 2 1/4
1/2 - 1	2 x 2 1/4	2 x 2 1/4

ORDERING INFORMATION

Display Pkg.-5 sets 1 Set per pkg.	OEM Bulk Pkg. 10 sets	Screw Size	Weight Pounds
968 DP CHR	968 000 CHR	6	3/4
1068 DP CHR	1068 000 CHR	6	3/4

Spare Flush Strike, Cat. No. 912 000 CHR.
Spare Knob and Handle Assembly, Cat. No. 995 000 CHR.

Spare Regular Bevel with Cam, Cat. No. 984 000 CHR.
Spare Reverse Bevel with Cam, Cat. No. 920 000 CHR.

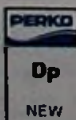

Dp
NEW

RIM LOCK SETS

FIGS. 918 & 919

Chrome Plated Zinc

Fig. 918 — Regular Bevel with Box Strike

Fig. 919 — Reverse Bevel with Flush Strike

Locked by Turn Button from Inside or Key from Outside.

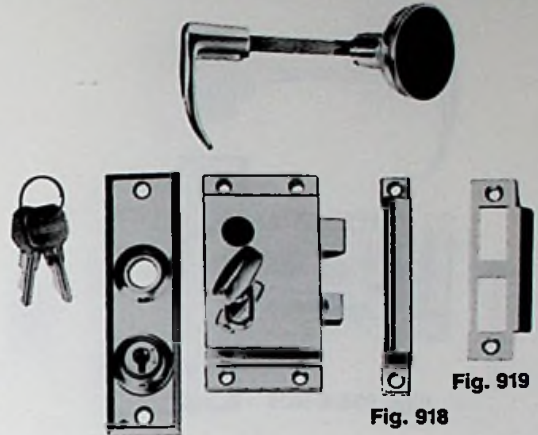

For Door Thickness Inches	Dimensions Case Inches	Dimensions Escutcheon Inches	ORDERING INFORMATION			
			Display Pkg.-5 sets 1 Set per card	OEM Bulk Pkg. 10 sets	Screw Size	Weight Pounds
5/8 - 1 3/8	3 7/8 x 2	4 3/8 x 1 1/4	918 DP CHR	918 000 CHR	6	1 1/4
5/8 - 1 3/8	3 7/8 x 2	4 3/8 x 1 1/4	919 DP CHR	919 000 CHR	6	1 1/4

Spare Box Strike, Cat. No. 918 000 99A.

Spare Flush Strike, Cat. No. 913 000 CHR.

Spare Knob and Handle Assembly, Cat. No. 962 000 CHR.

Spare Bevel with Cam for Both, Cat. No. 920 000 CHR.

Spare Escutcheon Plate with Keys, Cat. No. 953 000 CHR.



FLUSH CUP RIM LATCH SETS

FIGS. 1279 & 1280

Chrome Plated Zinc

Sliding Lock Button

Fig. 1279 — Regular Bevel with Box Strike

Fig. 1280 — Reverse Bevel with Flush Strike

Supplied with Black Plastic Spacer For Surface Mounting.

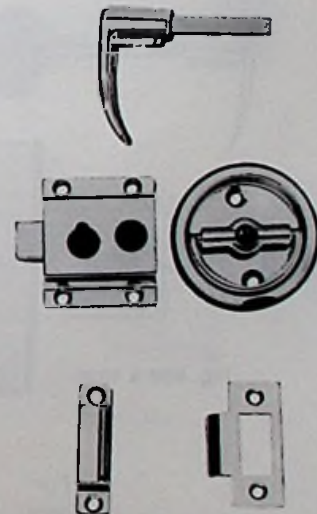

For Door Thickness Inches	Dimensions Case Inches	O.D. Cup Inches	ORDERING INFORMATION		
			Display Pkg.-5 sets 1 Set per card	OEM Bulk Pkg. 10 sets	Weight Pounds
3/4 - 1 1/8	2 1/8 x 1 3/4	2 1/4	1279 DP CHR	1279 000 CHR	1
3/4 - 1 1/8	2 1/8 x 1 3/4	2 1/4	1280 DP CHR	1280 000 CHR	1

Fig. 1279

Fig. 1280

Case Screw Size #6.

Cup Screw Size #8.

Spare Box Strike, Cat. No. 976 000 CHR.

Spare Flush Strike, Cat. No. 912 000 CHR.

Spare Regular Bevel with Cam, Cat. No. 984 000 CHR.

Spare Reverse Bevel with Cam, Cat. No. 920 000 CHR.



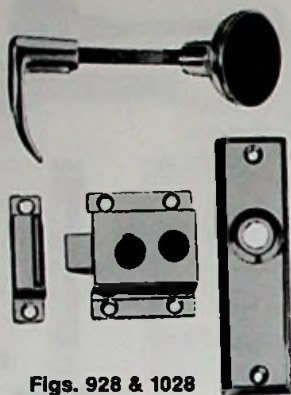

Figs. 928 & 1028

RIM LATCH SETS

FIGS. 928 & 1028

Chrome Plated Zinc

Sliding Lock Button

Fig. 928 — Regular Bevel with Box Strike

Fig. 1028 — Reverse Bevel with Box Strike

For Door Thickness Inches	Dimensions Case Inches	Dimensions Escutcheon Inches	ORDERING INFORMATION			
			Display Pkg.-5 sets 1 Set per card	OEM Bulk Pkg. 10 sets	Screw Size	Weight Pounds
5/8 - 1 3/8	2 1/8 x 1 3/4	4 3/8 x 1 1/4	928 DP CHR	928 000 CHR	6	3/4
5/8 - 1 3/8	2 1/8 x 1 3/4	4 3/8 x 1 1/4	1028 DP CHR	1028 000 CHR	6	3/4

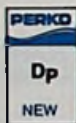

Spare Box Strike, Cat. No. 976 000 CHR.
Spare Knob and Handle Assembly, Cat. No. 962 000 CHR.

Spare Regular Bevel with Cam, Cat. No. 984 000 CHR.
Spare Reverse Bevel with Cam, Cat. No. 920 000 CHR.

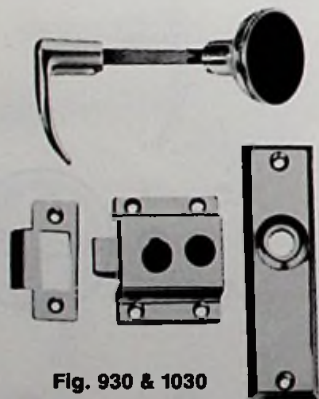

Fig. 930 & 1030

RIM LATCH SETS

FIGS. 930 & 1030

Chrome Plated Zinc

Sliding Lock Button

Fig. 930 — Reverse Bevel with Flush Strike

Fig. 1030 — Regular Bevel with Flush Strike

For Door Thickness Inches	Dimensions Case Inches	Dimensions Escutcheon Inches	ORDERING INFORMATION			
			Display Pkg.-5 sets 1 Set per card	OEM Bulk Pkg. 10 sets	Screw Size	Weight Pounds
5/8 - 1 3/8	2 1/8 x 1 3/4	4 3/8 x 1 1/4	930 DP CHR	930 000 CHR	6	3/4
5/8 - 1 3/8	2 1/8 x 1 3/4	4 3/8 x 1 1/4	1030 DP CHR	1030 000 CHR	6	3/4

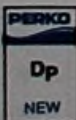

Spare Flush Strike, Cat. No. 912 000 CHR.
Spare Knob and Handle Assembly, Cat. No. 962 000 CHR.

Spare Regular Bevel with Cam, Cat. No. 984 000 CHR.
Spare Reverse Bevel with Cam, Cat. No. 920 000 CHR.

MORTISE LOCK SET

FIG. 927

Chrome Plated Zinc

Locked by Turn Button from Inside or Key from Outside.

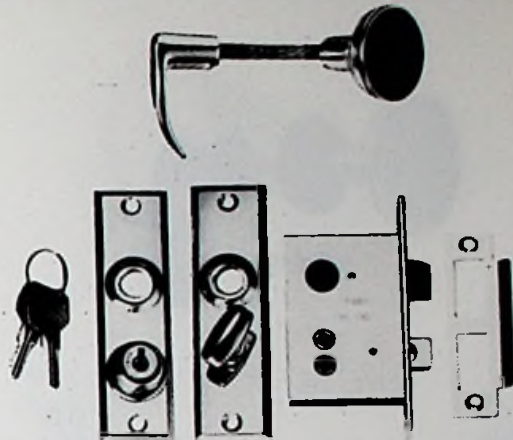
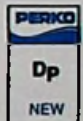

Fig. 927

For Door Thickness Inches	Dimensions Case Inches	Dimensions Escutcheon Inches	ORDERING INFORMATION			
			Display Pkg.-5 sets 1 Set per card	OEM Bulk Pkg. 10 sets	Screw Size	Weight Pounds
1 - 1 3/8	2 3/4 x 2	4 3/8 x 1 1/4	927 DP CHR	927 000 CHR	6	1 1/4

Spare Flush Strike, Cat. No. 913 000 CHR.
Spare Knob and Handle Assembly, Cat. No. 962 000 CHR.

Spare Bevel with Cam, Cat. No. 920 000 CHR.
Spare Escutcheon Plate with Keys, Cat. No. 927 000 99B.



MORTISE LATCH SET

FIG. 960

Chrome Plated Zinc

Turn Button Lock

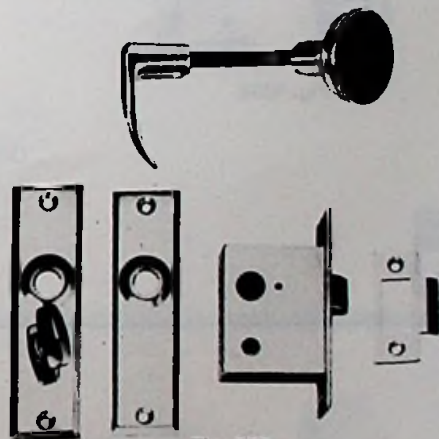

Fig. 960

For Door Thickness Inches	Dimensions Case Inches	Dimensions Escutcheon Inches	ORDERING INFORMATION			
			Display Pkg.-5 sets 1 Set per card	OEM Bulk Pkg. 10 sets	Screw Size	Weight Pounds
1 - 1 3/8	2 1/4 x 1 13/16	4 3/8 x 1 1/4	960 DP CHR	960 000 CHR	6	1

Spare Flush Strike, Cat. No. 912 000 CHR.
Spare Knob and Handle Assembly, Cat. No. 962 000 CHR.

Spare Bevel with Cam, Cat. No. 920 000 CHR.





Fig. 938

PULL AND LATCH ASSEMBLY FIG. 938

**Chrome Plated Zinc
Black Plastic Insert
Brass Stem**

ORDERING INFORMATION

O.D. Knob Inches	Max. Panel Thickness Inches	Display Pkg.-5 pcs. 1 Pc. per card	OEM Bulk Pkg. 50 pcs.	Weight Ounces
1 1/2	1 1/8	938 DP CHR	938 000 CHR	2



Spare Cam Bar, Cat. No. 938 000 99A.



Fig. 1056

ELBOW CATCH FIG. 1056

**Chrome Plated Zinc
Stainless Steel Spring**

ORDERING INFORMATION

Dimensions Inches	Display Pkg.-10 pcs. 1 Pc. per card	OEM Bulk Pkg. 50 pcs.	Screw Size	Weight Ounces
1 1/8 x 9/16	1056 DP CHR	1056 000 CHR	6	3/4



Fig. 1021

ELBOW CATCH FIG. 1021

**Black Plastic
Integral Spring**

ORDERING INFORMATION

Dimensions Inches	Display Pkg.-25 cds. 2 Pcs. per card	OEM Bulk Pkg. 100 pcs.	Screw Size	Weight Ounces
1 3/16 x 5/8	1021 DP BLK	1021 000 BLK	6	1/2



KNOB FIG. 925

**Chrome Plated Brass
Stainless Steel Screw**



Fig. 925

ORDERING INFORMATION

O.D. Inches	Max. Panel Thickness Inches	Display Pkg.-10 pcs. 1 Pc. per card	OEM Bulk Pkg. 50 pcs.	Weight Ounces
1	1 1/8	925 DP CHR	925 000 CHR	1 1/2



KNOB FIG. 926

**Chrome Plated Zinc
Stainless Steel Screw
Black Plastic Insert**



Fig. 926

ORDERING INFORMATION

O.D. Inches	Max. Panel Thickness Inches	Display Pkg.-10 pcs. 1 Pc. per card	OEM Bulk Pkg. 100 pcs.	Weight Ounces
1 1/8	1 1/8	926 DP0 CHR	926 000 CHR	3/4
1 1/2	1 1/8	926 DP1 CHR	926 001 CHR	1



FLUSH RING CATCH FIG. 1051

**Chrome Plated Zinc
Phosphor Bronze Spring**

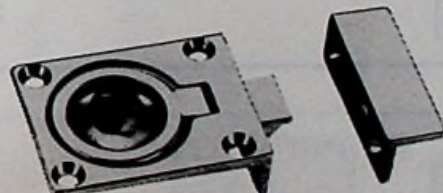

Fig. 1051

ORDERING INFORMATION

Dimensions Overall Inches	Display Pkg.-10 pcs. 1 Pc. per card	OEM Bulk Pkg. 25 pcs.	Screw Size	Weight Ounces
2 1/4 x 1 3/8	1051 DP CHR	1051 000 CHR	6	1 1/2



FLUSH RING PULL FIG. 841



Fig. 841



Chrome Plated Zinc

ORDERING INFORMATION

Dimensions	Display Pkg.-10 pcs.	OEM Bulk Pkg.	Screw Size	Weight Ounces
Face Plate Inches	1 Pc. per card	50 pcs.		
1 3/4 x 1 3/8	841 DP CHR	841 000 CHR	6	1

FLUSH RING PULL FIG. 1232



Fig. 1232



Chrome Plated Zinc

ORDERING INFORMATION

O.D. Face Plate Inches	Display Pkg.-5 pcs.	OEM Bulk Pkg.	Screw Size	Weight Ounces
1 5/8	1 Pc. per card	50 pcs.		
2	1232 DP1 CHR	1232 001 CHR	6	1
	1232 DP2 CHR	1232 002 CHR	6	1 1/2

FLUSH RING PULL FIG. 1103



Fig. 1103



Chrome Plated Bronze

ORDERING INFORMATION

Dimensions	Display Pkg.-5 pcs.	OEM Bulk Pkg.	Screw Size	Weight Ounces
Face Plate Inches	1 Pc. per card	50 pcs.		
2 9/16 x 2	1103 DP CHR	1103 000 CHR	8	3 1/2

FLUSH LIFTING PULL FIG. 575



Fig. 575



Chrome Plated Bronze

ORDERING INFORMATION

Dimensions	Display Pkg.-10 pcs.	OEM Bulk Pkg.	Screw Size	Weight Ounces
Face Plate Inches	1 Pc. per card	50 pcs.		
2 5/8 x 2	575 DP CHR	575 000 CHR	8	3

FLUSH PULL FIG. 1221

**Chrome Plated Zinc
Black Plastic Finishing Flange**

Spring Loaded, Can be Mounted Horizontally or Vertically.



Fig. 1221

Dimensions		ORDERING INFORMATION			
Flange Inches	Display Pkg.-5 pcs. 1 Pc. per card	OEM Bulk Pkg. 50 pcs.	Screw Size	Weight Ounces	
3/4 x 3 1/4	1221 DP CHR	1221 000 CHR	8	3	



RING PULLS FIGS. 1286 & 1288

Chrome Plated Zinc

Fig. 1286 — For Surface Mounting with Black Plastic Spacer.

Fig. 1288 — For Flush Mounting, Easily Installs in a 2 Inch Dia. Hole.



Fig. 1286

O.D. Cup Inches		Display Pkg.-5 pcs. 1 Pc. per card	Screw Size	Weight Ounces
2 1/4	1286 DP CHR	8	3 1/2	
2 1/4	1288 DP CHR	8	3 1/2	



FLUSH LIFTING HANDLE FIG. 776

Chrome Plated Bronze

Size No. 2 (not shown) Has All Mounting Holes at Corners.



Fig. 776

Dimensions		ORDERING INFORMATION			
Face Plate Inches	Inside Handle Inches	Display Pkg.-5 pcs. 1 Pc. per card	OEM Bulk Pkg. 25 pcs.	Screw Size	Weight Ounces
3 x 2 1/4	1 7/8 x 1	776 DP1 CHR	776 001 CHR	10	3 1/2
3 3/4 x 2 3/4	2 3/16 x 1 3/16	776 DP2 CHR	776 002 CHR	10	5 1/2



FLUSH LIFTING HANDLE FIG. 1220

Chrome Plated Zinc



Fig. 1220

Dimensions		ORDERING INFORMATION			
Face Plate Inches	Inside Handle Inches	Display Pkg.-5 pcs. 1 Pc. per card	OEM Bulk Pkg. 50 pcs.	Screw Size	Weight Ounces
3 x 2 1/4	1 7/8 x 1	1220 DP CHR	1220 000 CHR	8	3



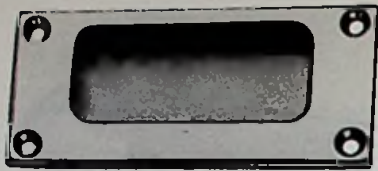

Fig. 1110

FLUSH PULL FIG. 1110

Chrome Plated Zinc

ORDERING INFORMATION

Dimensions Face Plate Inches	Depth Inches	Display Pkg.-5 pcs. 1 Pc. per card	OEM Bulk Pkg. 50 pcs.	Screw Size	Weight Ounces
3 11/16 X 1 11/16	7/16	1110 DP CHR	1110 000 CHR	6	3



Fig. 1016

FLUSH PULL FIG. 1016

Plastic
Black or White

Easily Installs in a 1 3/4 Inch Diameter Hole.

ORDERING INFORMATION

Color	Dimensions Face Plate Inches	Depth Inches	Display Pkg.-10 pcs. 1 Pc. per card	OEM Bulk Pkg. 100 pcs.	Screw Size	Weight Ounces
Black	2 1/4 x 2 1/4	15/16	1016 DP BLK	1016 000 BLK	6	1
White	2 1/4 x 2 1/4	15/16	1016 DP WHT	1016 000 WHT	6	1



Fig. 958

PULL FIG. 958

Chrome Plated Zinc

ORDERING INFORMATION

Width Overall Inches	Width Inside Inches	Display Pkg.-10 pcs. 1 Pc. per card	Screw Size	Weight Ounces
3 7/16	2 5/16	958 DP CHR	6	1

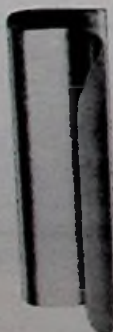

Fig. 954

SLIDING WINDOW HANDLE FIG. 954

Stainless Steel

ORDERING INFORMATION

For Glass Thickness Inches	Length Overall Inches	Display Pkg.-5 pcs. 1 Pc. per card	Weight Ounces
1/4	3	954 DP STS	1



SLIDING WINDOW STOP FIG. 935

Chrome Plated Zinc
Plastic Cover on Stopping Plate

Dimensions Mounting Plate Inches	Length Stopping Plate Inches	ORDERING INFORMATION			
		Display Pkg.-5 pcs. 1 Pc. per card	OEM Bulk Pkg. 50 pcs.	Screw Size	Weight Ounces
1 7/8 x 3/4	1 1/2	935 DP CHR	935 000 CHR	8	2

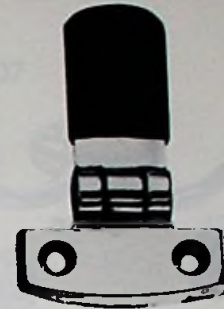

Fig. 935



SLIDING WINDOW LOCK & ANTI-RATTLER FIG. 937

Chrome Plated Zinc
Black Plastic Knob and Tip

Height Overall Inches	Dimensions Mounting Plate Inches	Adjustment Inches	ORDERING INFORMATION		
			Display Pkg.-5 pcs. 1 Pc. per card	Screw Size	Weight Ounces
1 5/8	1 x 5/8	1 1/8	937 DP CHR	6	1 1/4



Fig. 937



Spare Black Plastic Tip, Cat. No. 944.

SLIDING WINDOW LOCK & ANTI-RATTLER FIG. 934

Chrome Plated Zinc
Black Plastic Knob and Tip

Height Overall Inches	Dimensions Mounting Plate Inches	Adjustment Inches	ORDERING INFORMATION		
			Display Pkg.-5 pcs. 1 Pc. per card	Screw Size	Weight Ounces
1	2 x 5/8	1 1/8	934 DP CHR	6	1 1/4



Fig. 934



Spare Black Plastic Tip, Cat. No. 944.

FASTENER FIG. 719

Chrome Plated Brass
Black Plastic Knob with Stainless Steel Stud

Length Angle Inches	Width Angle Inches	ORDERING INFORMATION			
		Display Pkg.-5 pcs. 1 Pc. per card	OEM Bulk Pkg. 25 pcs.	Screw Size	Weight Ounces
1 3/8	1	719 DP CHR	719 000 CHR	8	3



Fig. 719



Spare Knob, Cat. No. 719 000 99A.

Spare Angle Bracket, Cat. No. 719 000 99B.

Spare Flat Plate, Cat. No. 719 000 99C.



Fig. 1106

UTILITY HOOK FIG. 1106

Chrome Plated Zinc

ORDERING INFORMATION

Projection Inches	Width Base Inches	Display Pkg.-10 pcs. 1 Pc. per card	OEM Bulk Pkg. 50 pcs.	Screw Size	Weight Ounces
3/4	1	1106 DP CHR	1106 000 CHR	6	3/4



Fig. 975

UTILITY HOOK FIG. 975

Chrome Plated Zinc

ORDERING INFORMATION

Projection Inches	Width Base Inches	Display Pkg.-10 pcs. 1 Pc. per card	OEM Bulk Pkg. 50 pcs.	Screw Size	Weight Ounces
2	1 1/8	975 DP1 CHR	975 001 CHR	6	1
3	1 1/4	975 DP2 CHR	975 002 CHR	6	1 1/2



Fig. 610

UTILITY HOOK FIG. 610

Chrome Plated Zinc

ORDERING INFORMATION

Projection Inches	Width Base Inches	Display Pkg.-10 pcs. 1 Pc. per card	OEM Bulk Pkg. 50 pcs.	Screw Size	Weight Ounces
1 3/8	1 1/8	610 DP CHR	610 000 CHR	6	1/2



"DURABLE TYPE" FASTENERS FIGS. 869, 896, 898, 901 & 907

Figs. 896, 898, 901 & 907 — Nickel Plated Brass
 Fig. 869 — Stainless Steel, 5/8 Inch Self Tapping Screw.

For Canvas to Surface, Use Figs. 869, 896 and 898.
 For Canvas to Canvas, Use Figs. 896, 898, 901 and 907.

ORDERING INFORMATION

Description	Std. Pkg.-100 pcs. OEM Pkg.-500 pcs.
Stud	869 000 STS
Stud	901 000 NKL
Socket	898 000 NKL
Button	896 000 NKL
Eyelet	907 000 NKL



Socket
Fig. 898



Stud
Fig. 901



Button
Fig. 896



Eyelet
Fig. 907

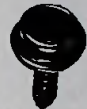

Stud
Fig. 869

"LIFT TYPE" FASTENERS FIGS. 60, 62, 116, 117 & 118

Figs. 60, 62, 116 & 118 — Nickel Plated Brass
 Fig. 117 — Stainless Steel, 1/2 Inch Self Tapping Screw.

ORDERING INFORMATION

Description	Standard Pkg.-100 pcs.
Clinch Stud	60 000 NKL
Clinch Washer	62 000 NKL
Clinch Plate	118 000 NKL
Stud	*117 000 STS
Socket	116 000 NKL

*OEM Pkg.-500 pcs.



Clinch Washer
Fig. 62



Clinch Stud
Fig. 60



Socket
Fig. 116



Clinch
Plate
Fig. 118



Stud
Fig. 117

CURTAIN FASTENERS FIGS. 994, 996 & 997

Nickel Plated Brass

ORDERING INFORMATION

Description	Standard Pkg.-100 pcs.
Flanged Stud	994 000 NKL
Eyelet	996 000 NKL
Washer	997 000 NKL



Eyelet
Fig. 996

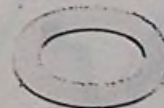

Washer
Fig. 997



Flanged Stud
Fig. 994



Socket
No. 3



Slide
No. 6
Ltr. S



Side Plate
No. 8



Hinge
No. 1
Ltr. H



Eye End
Nos. 5, 9

CONVERTIBLE TOP FITTINGS FIG. 395

Chrome Plated Zinc
Stainless Steel Screws

ORDERING INFORMATION

Description	Display Pkg.-5 cds. 2 Pcs. per card	OEM Bulk Pkg. 100 pcs.	Screw Size	Average Weight Ounces
Hinge for 3/4" fittings	395 DP1 CHR	395 001 CHR	8	2
Socket for 3/4" tubing	395 DP3 CHR	395 003 CHR	---	2
Eye End for 3/4" tubing with .049" wall	395 DP5 CHR	*395 005 CHR	---	2
Slide for 3/4" tubing	395 DP6 CHR	395 006 CHR	---	2
Side Mounting Plate	395 DP8 CHR	395 008 CHR	10	2
Eye End for 7/8" tubing	395 DP9 CHR	395 009 CHR	---	2
Slide for 7/8" tubing	395 DPS CHR	**395 010 CHR	---	2
Hinge for 7/8" fittings	395 DPH CHR	**395 011 CHR	8	2

*OEM Bulk Pkg.-200 pcs.

**OEM Bulk Pkg.-50 pcs.



Fig. 1249

UTILITY HOOK FIG. 1249

Chrome Plated Zinc

ORDERING INFORMATION

Length Overall Inches	Width Overall Inches	Inside Hook Inches	Display Pkg.-10 cds. 5 Pcs. per card	OEM Bulk Pkg. 100 pcs.	Screw Size	Weight Ounces
15/16	1/2	1/4	1249 DP CHR	1249 000 CHR	6	1/2



Fig. 578

BOAT COVER SOCKETS FIG. 578

Chrome Plated Zinc

Will Accommodate 3/8 Inch Wood or Plastic Battens
Up To 1 3/4 Inches Wide.

ORDERING INFORMATION

Length Overall Inches	Dimensions Opening Inches	Width Overall Inches	Display Pkg.-10 cds. 1 Pair per card	Screw Size	Weight per Pair Ounces
3 1/4	1 7/8 x 7/16	5/8	578 DP CHR	6	1/2



THE USAGE OF OUTRIGGERS by "Hank" Gartner

Outriggers for sport fishing boats were devised some time ago when it was observed that many members of the billfish family would strike sharply at a trolled bait, literally destroying it, then proceed on their way without getting hooked.

With the use of outriggers, the fishing line, after leaving the rod tip, leads to the "trolling pin" in its raised position. After leaving the pin, the line proceeds aft to the proper position in the wake of the boat that the captain deems best to give the proper trolling "action" to the bait being trolled, whether it be mullet, ballyhoo, squid, line bait, etc.

Using outriggers, the fish, after striking vigorously at the trolled bait, releases the line from the pin. This creates a slack loop of line, which in turn lets the struck bait lie motionless in the water.

In theory, the fish believing his prey is stunned, grabs the bait and attempts to make off with it. When the fish runs out of the slack loop of line, he is brought up by the taut line; theoretically he should be hooked.

Outrigger poles should be parallel when in their vertical position. To accomplish this, it may be necessary to build up the deck under the bases of the outrigger pole holders with small teak wedges or fiberglass putty.

It is recommended to have the top guide a few inches down from the extreme tip of the pole. This precludes the possibility of the pin wrapping around and tangling on the pole. Should the owner wish to install dual pins, they should be approximately three feet apart on the same lead line. The small cleats should be secured aft of the outrigger base, thus keeping the "trolling pin" line clear of the outrigger pole and return line.

CAT. NO.
1798 OR
460 POLES
WITH
CAT. NO. 471
AND
CAT. NO. 468
LINE GUIDES



CRUISING POSITION

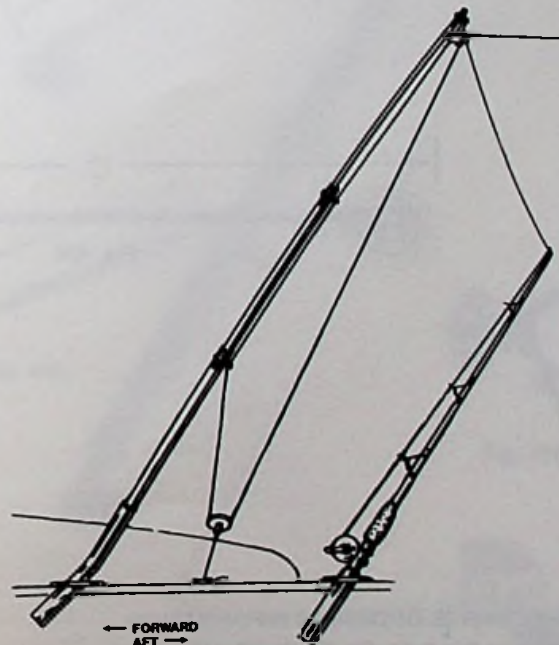

TROLLING POSITION

FLYING BRIDGE RELEASE OUTRIGGER POLE HOLDERS FIG. 425

STAINLESS STEEL MAIN TUBE AND SUPPORT ARMS CHROME PLATED BRONZE FITTINGS.

An adjustable length, hinged support arm allows the pole holder to be raised and lowered remotely with the use of a line running through an eye on the hinge and attached to the integral eye on the upper stop collar (Fig. No. 409). The main tube and both support arms have heavy swivel mounting bases for versatility of installation and use. Large knobs on the sliding clamps provide ready adjustment for all fishing positions. Stainless steel drift pins on both sliding clamps are pulled to release the pole holder to the down and aft position. Sturdy folding lay down hooks (Fig. No. 410) are included for supporting the outriggers in the down position. A second stop collar (Fig. No. 415) is included for presetting the desired fishing angle. The flying bridge holding bracket (Fig. No. 423) has a heavy swivel mounting base and is hinged for quick release.

ORDERING INFORMATION

"A" Length Main Tube Feet	Standard Pkg.-1 pair	"B" Length Upper Arm Inches	"C" Length Lower Arm Inches	Weight per Pair Pounds
4	425 004 CHR	23-33	41 7/8	65
6	425 006 CHR	35-45	50 3/8	75
8	425 008 CHR	46-56	74 1/2	95

For Use With Outriggers Cat. Nos. 1798 019 ALU, 1798 019 BLK, 1798 022 ALU,
1798 022 BLK, 1798 025 ALU and 1798 025 BLK.

Main Tube O.D.-2".

Mounting Flanges O.D.-4".

Main Tube I.D.-1.900".

Bolt Size-1/4".

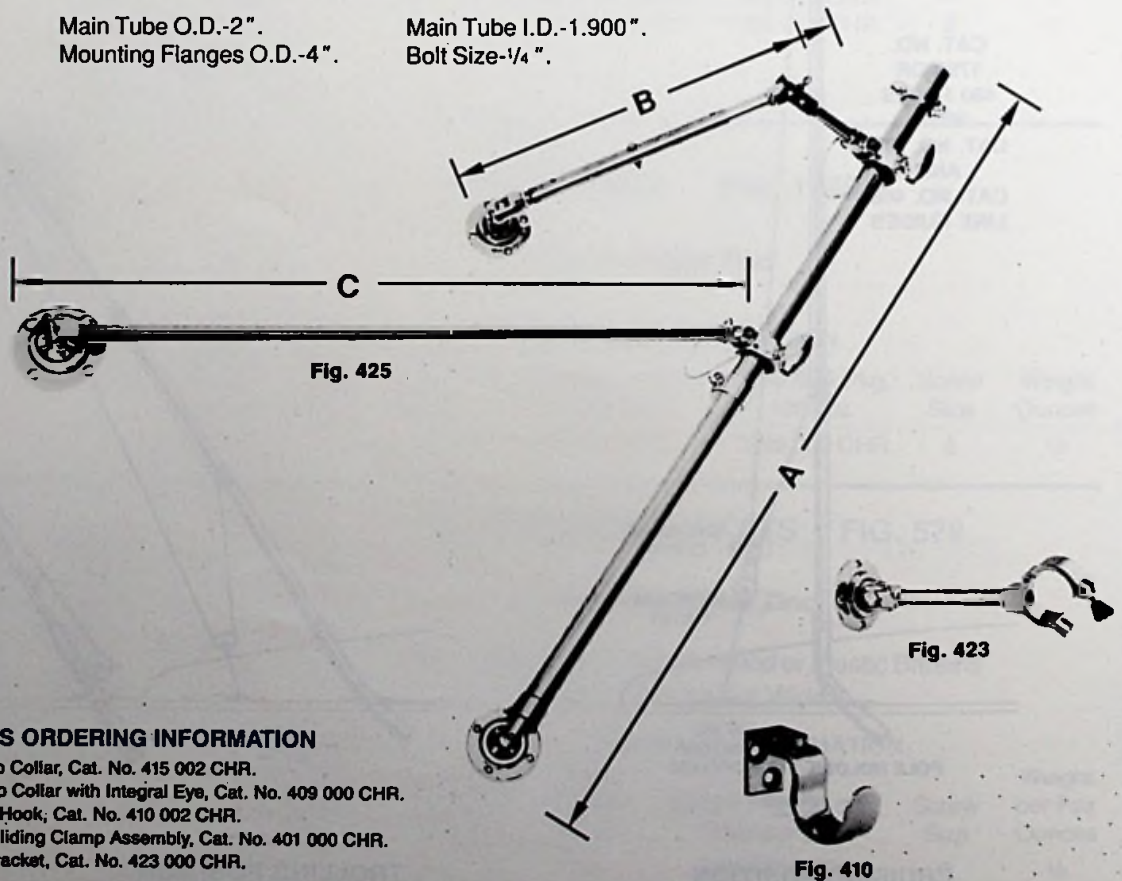

SPARE PARTS ORDERING INFORMATION

- Spare Lower Stop Collar, Cat. No. 415 002 CHR.
- Spare Upper Stop Collar with Integral Eye, Cat. No. 409 000 CHR.
- Spare Lay Down Hook, Cat. No. 410 002 CHR.
- Spare Knob for Sliding Clamp Assembly, Cat. No. 401 000 CHR.
- Spare Holding Bracket, Cat. No. 423 000 CHR.

OUTRIGGER POLE HOLDERS FIG. 400

STAINLESS STEEL MAIN TUBE AND SUPPORT ARMS CHROME PLATED BRONZE FITTINGS.

A large knob on the sliding clamps provide ready adjustment for all fishing positions. All joints swivel for easy installation and use. A stop collar, with an integral eye for the lifting line, is included for presetting the desired fishing angle. Sturdy folding lay down hooks (Fig. No. 410) are also included for supporting the outriggers in the down position. The upper holding bracket (Fig. No. 408) is hinged for quick release.

ORDERING INFORMATION

"A" Length Main Tube Feet	Standard Pkg.-1 pair	"B" Length Upper Arm Inches	"C" Length Lower Arm Inches	Weight per Pair Pounds
4	400 004 CHR	27 1/4	41 7/8	59
6	400 006 CHR	38 7/8	50 3/8	70
8	400 008 CHR	50 3/8	74 1/2	90

For Use With Outriggers Cat. Nos. 1798 019 ALU, 1798 019 BLK, 1798 022 ALU,
1798 022 BLK, 1798 025 ALU and 1798 025 BLK.

Main Tube O.D.-2". Main Tube I.D.-1.900".
Mounting Flanges O.D.-4". Bolt Size-1/4".

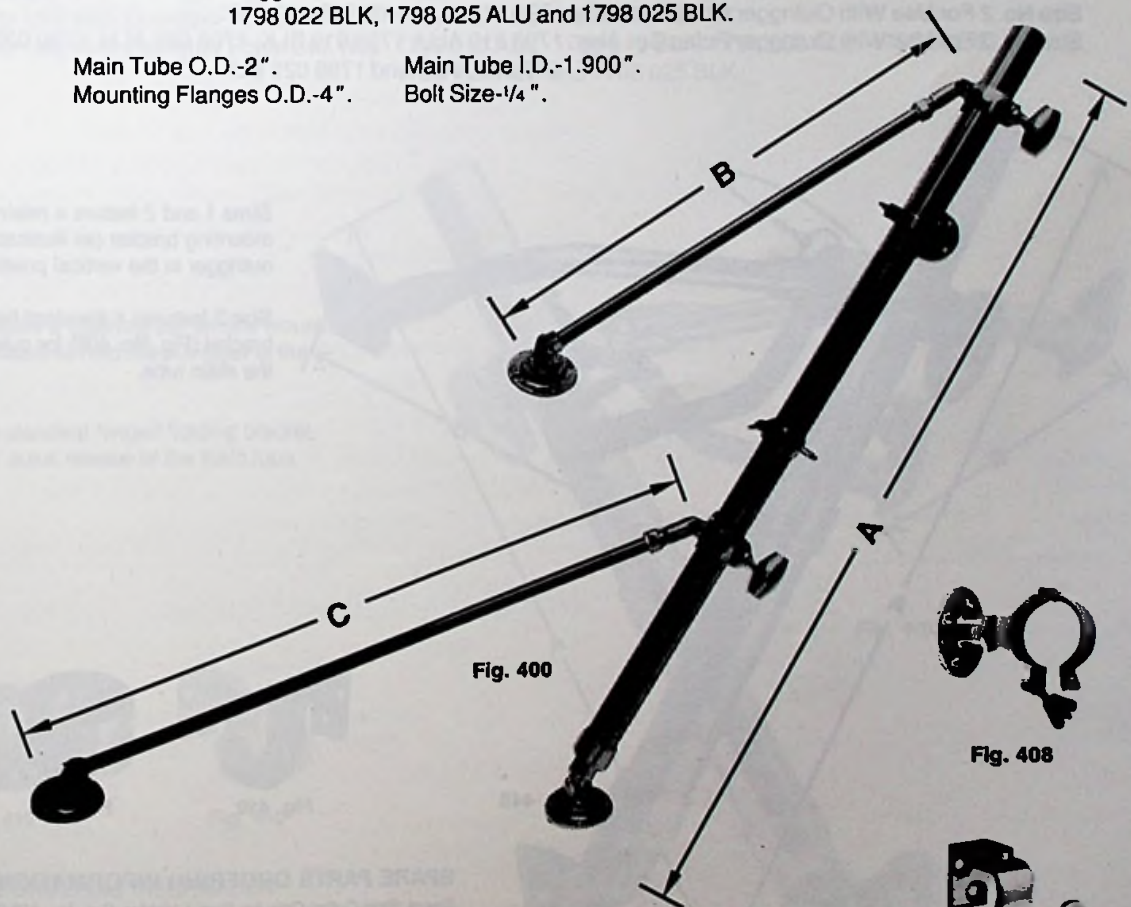

Fig. 400

Fig. 408

Fig. 410

SPARE PARTS ORDERING INFORMATION

- Spare Stop Collar, Cat. No. 409 000 CHR.
- Spare Lay Down Hook, Cat. No. 410 002 CHR.
- Spare Knob for Sliding Clamp Assembly, Cat. No. 401 000 CHR.
- Spare Holding Bracket, Cat. No. 408 000 CHR.

OUTRIGGER POLE HOLDERS FIG. 445

STAINLESS STEEL MAIN TUBE CHROME PLATED BRASS YOKE TUBING AND BRONZE FITTINGS.

A large knob on the sliding clamp provides ready adjustment for all fishing positions. A stainless steel drift pin in the sliding clamp is pulled to release the pole holder to a down and aft position. Features include heavy bidirectional hinged mounting base for easy installation on a horizontal or vertical surface. A stop collar (Fig. No. 415) included for presetting the desired fishing angle. A sturdy folding lay down hook (Fig. No. 410) are also included for supporting the outriggers in the down position. The mounting yokes may be installed in an inverted position, rather than that shown, to accommodate various installation requirements.

ORDERING INFORMATION

Holder Size No.	I.D. Main Tube Inches	"A" Length Main Tube Inches	O.D. Main Tube Inches	Standard Pkg.-1 pr.	"B" Yoke Width Inches	Weight Per Pair Pounds	Bolt Size Inches
1	1.500	20	1 $\frac{5}{8}$	445 001 CHR	11 $\frac{3}{4}$	22	$\frac{1}{4}$
2	1.900	20	2	445 002 CHR	11 $\frac{3}{4}$	24	$\frac{1}{4}$
3	1.900	35	2	445 003 CHR	24	33	$\frac{1}{4}$

Size No. 1 For Use With Outrigger Poles Cat. Nos. 1798 016 ALU, 1798 016 BLK, 1798 018 ALU and 1798 018 BLK.

Size No. 2 For Use With Outrigger Poles Cat. Nos. 1798 019 ALU and 1798 019 BLK.

Size No. 3 For Use With Outrigger Poles Cat. Nos. 1798 019 ALU, 1798 019 BLK, 1798 022 ALU, 1798 022 BLK, 1798 025 ALU and 1798 025 BLK.

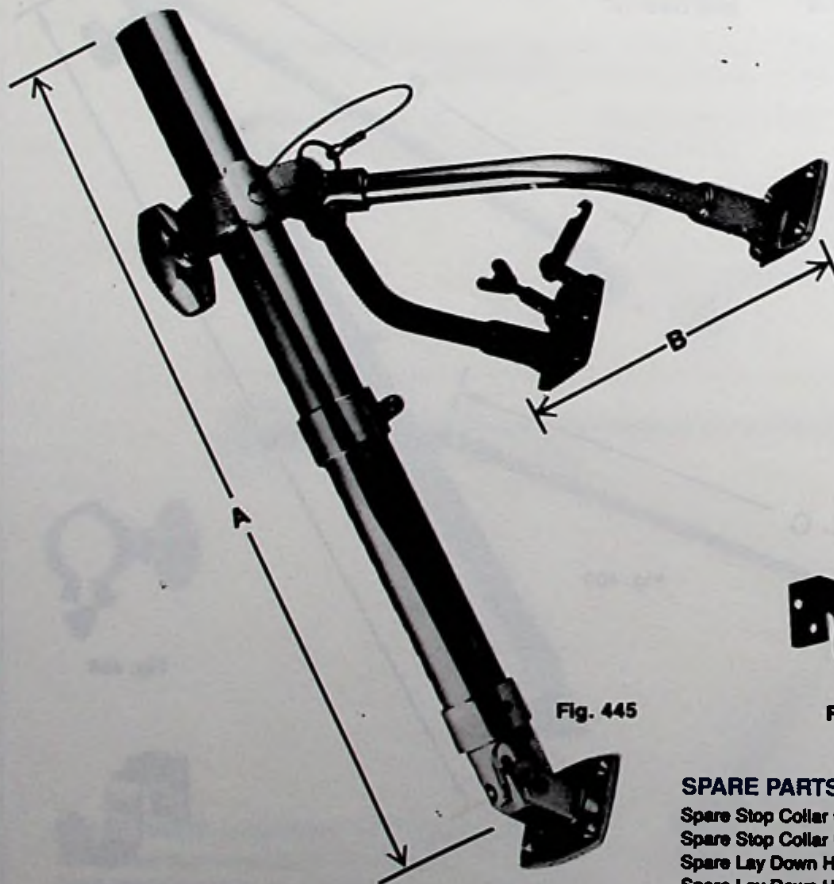

Fig. 445

Sizes 1 and 2 feature a retaining bar on one mounting bracket (as illustrated) to hold the outrigger in the vertical position.

Size 3 features a standard hinged holding bracket (Fig. No. 408) for quick release of the main tube.



Fig. 410



Fig. 415

SPARE PARTS ORDERING INFORMATION

Spare Stop Collar Only for Size 1 Holder, Cat. No. 415 001 CHR.

Spare Stop Collar for Size 2 and 3 Holders, Cat. No. 415 002 CHR.

Spare Lay Down Hook for Size 1 Holder, Cat. No. 410 001 CHR.

Spare Lay Down Hook for Size 2 and 3 Holders, Cat. No. 410 002 CHR.

Spare Port Locking Bar Assembly with Stud, Cat. No. 406 P00 99A.

Spare Starboard Locking Bar Assembly with Stud, Cat. No. 406 S00 99A.

Spare Knob for Sliding Clamp Assembly, Cat. No. 401 000 CHR.

OUTRIGGER POLE HOLDERS FIG. 470

STAINLESS STEEL MAIN TUBE CHROME PLATED BRASS YOKE TUBING AND BRONZE FITTINGS.

A large knob on the sliding clamp provides ready adjustment for all fishing positions. A stainless steel drift pin in the sliding clamp is pulled to release the pole holder to a down and aft position. Features include a heavy swivel mounting base for easy installation on a horizontal or vertical surface. A stop collar (Fig. No. 415) included for presetting the desired fishing angle. Sturdy folding lay down hooks (Fig. No. 410) are also included for supporting the outriggers in the down position. The mounting yokes may be installed in an inverted position, rather than that shown, to accommodate various installation requirements.

ORDERING INFORMATION

Holder Size No.	I.D. Main Tube Inches	"A" Length Main Tube Inches	O.D. Main Tube Inches	Standard Pkg.-1 pr.	"B" Yoke Width Inches	Weight Per Pair Pounds	Bolt Size Inches
1	1.500	20	1 $\frac{5}{8}$	470 001 CHR	11 $\frac{3}{4}$	22	$\frac{1}{4}$
2	1.900	20	2	470 002 CHR	11 $\frac{3}{4}$	24	$\frac{1}{4}$
3	1.900	35	2	470 003 CHR	24	33	$\frac{1}{4}$

Size No. 1 For Use With Outrigger Poles Cat. Nos. 1798 016 ALU, 1798 016 BLK, 1798 018 ALU and 1798 018 BLK.

Size No. 2 For Use With Outrigger Poles Cat. Nos. 1798 019 ALU and 1798 019 BLK.

Size No. 3 For Use With Outrigger Poles Cat. Nos. 1798 019 ALU, 1798 019 BLK, 1798 022 ALU, 1798 022 BLK, 1798 025 ALU and 1798 025 BLK.

Sizes 1 and 2 feature a retaining bar on one mounting bracket (as illustrated) to hold the outrigger in the vertical position.

Size 3 features a standard hinged holding bracket (Fig. No. 408) for quick release of the main tube.

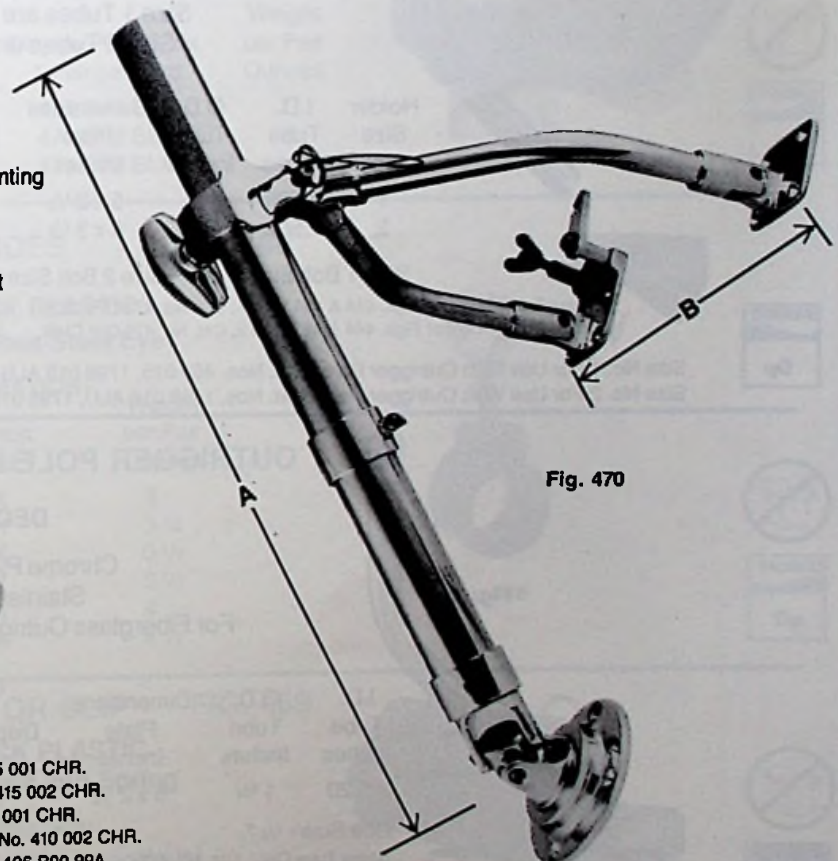

Fig. 470



Fig. 415



Fig. 410

SPARE PARTS ORDERING INFORMATION

- Spare Stop Collar Only for Size 1 Holder, Cat. No. 415 001 CHR.
- Spare Stop Collar for Size 2 and 3 Holders, Cat. No. 415 002 CHR.
- Spare Lay Down Hook for Size 1 Holder, Cat. No. 410 001 CHR.
- Spare Lay Down Hook for Size 2 and 3 Holders, Cat. No. 410 002 CHR.
- Spare Port Locking Bar Assembly with Stud, Cat. No. 406 P00 99A.
- Spare Starboard Locking Bar Assembly with Stud, Cat. No. 406 S00 99A.
- Spare Knob for Sliding Clamp Assembly, Cat. No. 401 000 CHR.

OUTRIGGER POLE HOLDERS

Removable Tubes Lift and Turn to Three Positions: Vertical, Fishing and Lowered. Universal Tubes May Be Used on Either Side. Supplied in Pairs consisting of Two Mounts and Two Tubes.

OUTRIGGER POLE HOLDERS FIG. 444

SIDE MOUNT

Chrome Plated Bronze Brackets
 Size 1 Tubes are Polished Stainless Steel.
 Size 2 Tubes are Chrome Plated Brass.

Fig. 444

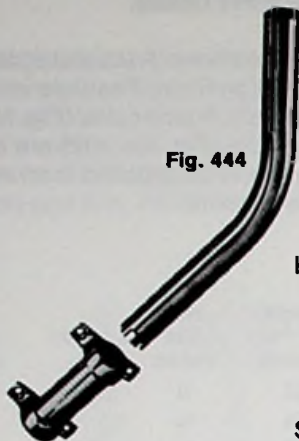

ORDERING INFORMATION

Holder Size No.	I.D. Tube Inches	O.D. Tube Inches	Dimensions Bracket Inches	Display Pkg.-5 pkgs. 1 Pair per pkg.	Standard Pkg.-1 pair	Weight per Pair Pounds
1	1.120	1 1/4	4 1/2 x 3	444 DP1 CHR	-----	4 5/8
2	1.500	1 5/8	6 1/2 x 4	-----	444 002 CHR	8 1/4

Size 1 Bolt Size - 1/4". Size 2 Bolt Size - 5/16".

Spare Bracket For Size No. 1, Cat. No. 478 001 CHR. Spare Bracket For Size No. 2, Cat. No. 478 002 CHR



OUTRIGGER POLE HOLDERS FIG. 451

DECK MOUNT

Chrome Plated Bronze Plates
 Size 1 Tubes are Polished Stainless Steel.
 Size 2 Tubes are Chrome Plated Brass.

Fig. 451

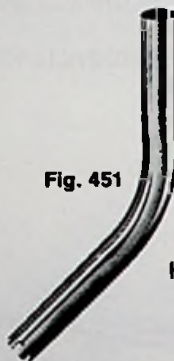

ORDERING INFORMATION

Holder Size No.	I.D. Tube Inches	O.D. Tube Inches	Dimensions Plate Inches	Display Pkg.-5 pkgs. 1 Pair per pkg.	Standard Pkg.-1 pair	Weight per Pair Pounds
1	1.120	1 1/4	5 x 2 1/2	451 DP1 CHR	-----	6 5/8
2	1.500	1 5/8	6 x 3 1/2	-----	451 002 CHR	11 1/4

Size 1 Bolt Size - 1/4". Size 2 Bolt Size - 5/16".

Spare Tube Only For Figs. 444 & 451 Size 1, Cat. No. 479 DP1 STS.

Spare Tube Only For Figs. 444 & 451 Size 2, Cat. No. 479 002 CHR.

Spare Plate Only For Size No. 1, Cat. No. 474 001 CHR.

Spare Plate Only For Size No. 2, Cat. No. 474 002 CHR.

Size No. 1 For Use With Outrigger Poles Cat. Nos. 460 015, 1798 015 ALU and 1798 015 BLK.

Size No. 2 For Use With Outrigger Poles Cat. Nos. 1798 016 ALU, 1798 016 BLK, 1798 018 ALU and 1798 018 BLK.



OUTRIGGER POLE HOLDERS FIG. 1314

DECK MOUNT

Chrome Plated Zinc Plates.*
 Stainless Steel Tubes.

For Fiberglass Outrigger Poles, Cat. No. 460 015.

Fig. 1314

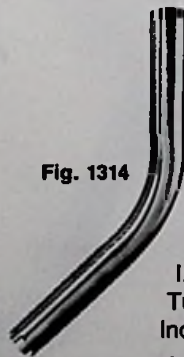

ORDERING INFORMATION

I.D. Tube Inches	O.D. Tube Inches	Dimensions Plate Inches	Display Pkg.-5 pkgs. 1 Pair per pkg.	OEM Bulk Pkg. 10 pairs	Weight per Pair Pounds
1.120	1 1/4	5 x 2 1/2	1314 DP CHR	1314 000 CHR	4 3/4

Bolt Size - 1/4".

Spare Tube Only, Cat. No. 479 DP1 STS.

Spare Plate Only, Cat. No. 1320 000 CHR.



*NOT DESIGNED FOR USE WITH ALUMINUM POLES.

OUTRIGGER POLES

FIG. 460

TELESCOPING FIBERGLASS With Reinforced Joints

Complete with Tip Roller (Fig. No. 471) and
Standard (Fig. No. 468) Line Guides.

For Use With Nos. 444 DP1 CHR, 451 DP1 CHR and 1314 DP CHR Holders.

Open Length	O.D. Base	Closed Length	Number of Sections	Standard Pkg.-1 pair	Weight per Pair Pounds
15 Feet	1.120 Inches	5 1/2 Feet	3	460 015	3 1/2

Single Pole Only, Cat. No. 460 015 98A.

Fig. 460

Fig. 476

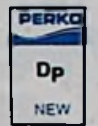
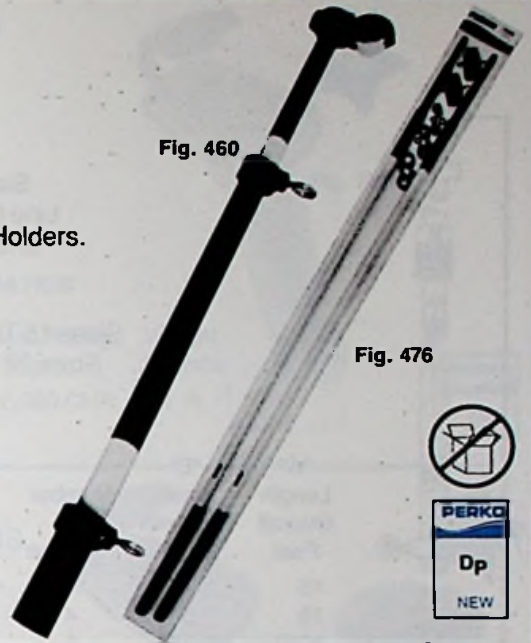

FIBERGLASS OUTRIGGER KIT

FIG. 476

ORDERING INFORMATION

Consists of One Pair of Fig. No. 460 Poles
with Fig. No. 471 Tip Roller Guides, Fig. No. 468
Standard Guides and Fig. No. 469 Clips.

Display Pkg.-3 pkgs.
1 Kit per pkg.
476 DP

OUTRIGGER POLE ROLLER TIP LINE GUIDE

FIG. 471

HIGH IMPACT BLACK PLASTIC With 7/8 Inch O.D. Nylon Sheave

ORDERING INFORMATION

I.D. Body Inches	For Use With Outrigger Pole Size	Maximum Rope Size Inches	Display Pkg.-5 cds. 1 Pair per card	Weight per Pair Ounces
9/16	460 and 476	1/4	471 DP1 BLK	1
5/8	1798 015	1/4	471 DP2 BLK	1
3/4	1798 016 thru 025	1/4	471 DP3 BLK	1



Fig. 471



OUTRIGGER POLE LINE GUIDES

FIG. 468

HIGH IMPACT BLACK PLASTIC With 3/8 Inch I.D. Stainless Steel Eye

ORDERING INFORMATION

I.D. Body Inches	Display Pkg.-5 cds. 2 Pcs. per card	Weight per Pair Ounces
9/16	468 DP1 BLK	3
5/8	468 DP2 BLK	3 1/2
3/4	468 DP3 BLK	3 1/2
1	468 DP4 BLK	3 1/2
1 3/16	468 DP5 BLK	4
1 5/8	468 DP6 BLK	4 1/2



Fig. 468



OUTRIGGER TROLLING PIN OR CLIP

FIG. 469

HIGH IMPACT BLACK PLASTIC with Stainless Steel Eyes and Spring

ORDERING INFORMATION

Dimensions Inches	Display Pkg.-5 cds. 2 Pcs. per card	Weight Ounces
2 3/4 x 1 3/8	469 DP BLK	1 1/2



Fig. 469



OUTRIGGER POLES FIG. 1798

**Silver or Black Anodized Aluminum
With Black Plastic Insulated Base**

Sizes 15 Through 19 Have Standard (Fig. No. 468)
Line Guides, Sizes 22 and 25 Have Integral Line Guides
and All Sizes Have Tip Roller (Fig. 471) Line Guides.

Heavy Duty Poles For Rough Water Use.
Sizes 15 Through 19 Have Sections Threaded For Easy Assembly,
Sizes 22 and 25 Have Sections Thru-Bolted For Extra Strength.

ORDERING INFORMATION

"A" Length Overall Feet	"B" Base Diameter Inches	Number of Sections	Silver Standard Pkg.-1 pair Cat. No.	Black Standard Pkg.-1 pair Cat. No.	Silver Single Pole Only Cat. No.	Black Single Pole Only Cat. No.	Weight per Pair Pounds
15	1.120	4	1798 015 ALU	1798 015 BLK	1798 015 99A	1798 B15 99A	6 1/2
15	1.500	4	1798 016 ALU	1798 016 BLK	1798 016 99A	1798 B16 99A	8 1/4
18 2/3	1.500	5	1798 018 ALU	1798 018 BLK	1798 018 99A	1798 B18 99A	12 5/8
18 2/3	1.900	5	1798 019 ALU	1798 019 BLK	1798 019 99A	1798 B19 99A	12 3/4
22 1/4	1.900	6	1798 022 ALU	1798 022 BLK	1798 022 99A	1798 B22 99A	17 5/8
25 1/2	1.900	7	1798 025 ALU	1798 025 BLK	1798 025 99A	1798 B25 99A	24 5/8

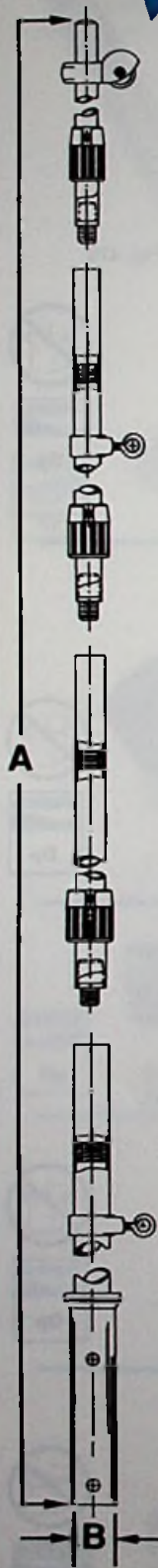

SPREADERS FIGS. 1714 & 1715

**Anodized Aluminum
Spreader Arms and Eye Bands
Silver or Gold**

Designed For Use With Our Aluminum Outrigger Poles
When Maximum Rigidity is Desired.
Spreaders Are Suggested For Use On 18 and 19 Foot Outrigger Poles
and Recommended For Use On 22 and 25 Foot Outrigger Poles.

Supplied in Pairs, Consisting of: Spreaders,
Stainless Steel Cable, Eye Bands and Turnbuckles.

ORDERING INFORMATION

For Use With Outrigger Poles Catalog Numbers	Silver Single Spreader Standard Pkg.-1 pair	Gold Single Spreader Standard Pkg.-1 pair	Silver Double Spreader Standard Pkg.-1 pair	Gold Double Spreader Standard Pkg.-1 pair
1798 018 ALU & 1798 018 BLK	1714 018	1714 018 GLD	-----	-----
1798 019 ALU & 1798 019 BLK	1714 018	1714 018 GLD	-----	-----
1798 022 ALU & 1798 022 BLK	1714 022	1714 022 GLD	1715 022	1715 022 GLD
1798 025 ALU & 1798 025 BLK	-----	-----	1715 025	1715 025 GLD

Fig. 1798

Fig. 1714
SINGLE

Fig. 1715
DOUBLE

FISHING ROD HOLDER FIG. 1205

FLUSH MOUNT

Chrome Plated Zinc Flange,
Anodized Aluminum Tube
With Soft Black Flange Gasket and Integral Flip-up Cap.



Fig. 1205

ORDERING INFORMATION

I.D. Tube Inches	O.D. Tube Inches	Length Under Flange Inches	Dimensions Flange Inches	Display Pkg. -5 pcs. 1 Pc. per Pkg.	OEM Bulk Pkg. 20 pcs.	Weight Pounds
1 5/8	2	8	4 1/4 x 3 1/2	1205 DP CHR	1205 000 CHR	1 1/2

Bolt Size 1/4"



FISHING ROD HOLDERS FIGS. 447 & 448

FLUSH MOUNT

Chrome Plated Bronze Flange,
Chrome Plated Brass Tube.



Fig. 448-1



Fig. 447

Fig. 447 — Hard Black Plastic Liner.

Fig. 448 No. 1 — Soft Black Liner and Flange Gasket with Integral Flip-up Cap.

Fig. 448 No. 2 — Soft Black Liner with Lip Only.

ORDERING INFORMATION

I.D. Tube Inches	O.D. Tube Inches	Length Under Flange Inches	Dimensions Flange Inches	Display Pkg. -5 pcs. 1 Pc. per pkg.	OEM Bulk Pkg. 10 pcs.	Bolt Size	Weight Pounds
1 5/8	2	9	3 1/2 O.D.	447 DP1 CHR	447 001 CHR	10	1 1/4
1 5/8	2	8	4 1/4 x 3 1/2	448 DP1 CHR	448 001 CHR	1/4	2
1 7/8	2 1/4	12	4 7/8 x 4	*448 DP2 CHR	-----	1/4	3 3/8

*Display Pkg. -1 card, 1 Pc. per card



FISHING ROD HOLDER FIG. 452

FLUSH MOUNT

Polished Stainless Steel Flange,
Stainless Steel Tube.
With Soft Black Flange Gasket and Integral Flip-up Cap.



Fig. 452

ORDERING INFORMATION

I.D. Tube Inches	O.D. Tube Inches	Length Under Flange Inches	Dimensions Flange Inches	Display Pkg. -5 pcs. 1 Pc. per pkg.	OEM Bulk Pkg. 10 pcs.	Weight Pounds
1 5/8	2	8 1/4	4 1/8 x 3 3/8	452 DP STS	452 000 STS	1 3/8

Bolt Size #10.



SPARE PARTS ORDERING INFORMATION

Spare Liner with Lip and Tube, See Fig. 482 DP, Specify Size, Page 192.
Spare Cap and Gasket Kit, See Figs. 480 DP and 481 DP, Specify Type, Page 192.



Fig. 1100

FISHING ROD HOLDER FIG. 1100

SIDE MOUNT

Chrome Plated Brass
With Soft Black Liner.

I.D. Tube Inches	O.D. Tube Inches	Length Overall Inches	Width Bracket Inches	ORDERING INFORMATION		
				Display Pkg.-5 pcs. 1 Pc. per pkg.	OEM Bulk Pkg. 10 pcs.	Weight Pounds
1 5/8	2	9	3	1100 DP CHR	1100 000 CHR	1 1/4

Bolt Size #8 R.H.

Spare Bracket, Cat. No. 1107 000 CHR.
Spare Liner with Lip and Tube, Cat. No. 483 DP1 BLK.

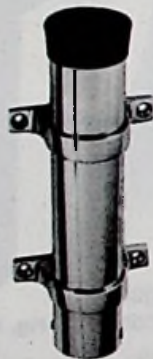

Fig. 404

HEAVY DUTY FISHING ROD HOLDER FIG. 404

SIDE MOUNT

Chrome Plated Brass and Bronze
with Soft Black Liner.

I.D. Tube Inches	O.D. Tube Inches	Length Overall Inches	Width Bracket Inches	ORDERING INFORMATION	
				Display Pkg.-5 pcs. 1 Pc. per pkg.	Weight Pounds
1 5/8	2	9	4 3/16	404 DP1 CHR	2
1 7/8	2 1/4	11	4 3/4	*404 DP2 CHR	3 1/8

Bolt Size 1/4".

* Display Pkg.-1 card, 1 Pc. per card.

Spare Bracket for Size No. 1, Cat. No. 404 001 99A.
Spare Bracket for Size No. 2, Cat. No. 404 002 99A.
Spare Liner with Lip and Tube, See Fig. No. 483 DP, Specify Size, Page 192.



Fig. 1104

FISHING ROD HOLDER FIG. 1104

SIDE MOUNT

Black Plastic
With Chrome Plated Brass Brackets.

I.D. Tube Inches	O.D. Tube Inches	Length Overall Inches	Width Bracket Inches	ORDERING INFORMATION		
				Display Pkg.-5 pcs. 1 Pc. per pkg.	OEM Bulk Pkg. 25 pcs.	Weight Pounds
1 5/8	2	9	3 1/4	1104 DP BLK	1104 000 BLK	5/8

Bolt Size #8 R.H.

Spare Bracket, Cat. No. 1107 000 CHR.



FISHING ROD HOLDER FIG. 1118

CLAMP ON

Chrome Plated Brass and Bronze with Soft Black Liner.

Clamp-On Feature Eliminates Drilling Rail and Simplifies Relocation.

Mounts on Vertical or Horizontal Rails.

Adjustable For Rails $\frac{7}{8}$ to 1 Inch in Diameter
and by Reducing Mounting Bolt Length, $\frac{3}{4}$ Inch Diameter Rails.



Fig. 1118

ORDERING INFORMATION

I.D. Tube Inches	O.D. Tube Inches	Length Overall Inches	Standard Pkg.-1 pc.	Weight Pounds
1 $\frac{5}{8}$	2	9	1118 000 CHR	2 $\frac{1}{4}$

Spare Face Plate with Bolts, Cat. No. 1118 000 99A.

Spare Intermediate Plate, Cat. No. 1118 000 99B.

Spare Liner with Lip and Tube, Cat. No. 483 DP1 BLK.

FISHING ROD HOLDER FIG. 1215

CLAMP ON

Chrome Plated Zinc with Polished Stainless Steel Tube
Hard Black Plastic Liner

Clamp-On Feature Eliminates Drilling Rail and Simplifies Relocation.

Mounts on Vertical or Horizontal Rails.

Adjustable for Rails $\frac{7}{8}$ to 1 Inch in Diameter
and By Reducing Mounting Bolt Length, $\frac{3}{4}$ Inch Diameter Rails.



Fig. 1215

ORDERING INFORMATION

I.D. Tube Inches	O.D. Tube Inches	Length Overall Inches	Display Pkg.-5 pcs. 1 Pc. per pkg.	Weight Pounds
1 $\frac{5}{8}$	2	9	1215 DP CHR	2

Spare Face Plate with Bolts, Cat. No. 1215 000 99A.

Spare Intermediate Plate, Cat. No. 1215 000 99B.



FISHING ROD HOLDER FIG. 475

ADJUSTABLE

Chrome Plated Brass and Manganese Bronze with Soft Black Liner.

May be Adjusted Quickly to Desired Angle From Vertical
to Horizontal and Locked in Place With a Large Thumb Bolt.



Fig. 475

ORDERING INFORMATION

I.D. Tube Inches	O.D. Tube Inches	Length Overall Inches	Dimensions Base Inches	Display Pkg.-1 pc. 1 Pc. per card	Weight Pounds
1 $\frac{5}{8}$	2	9 $\frac{1}{2}$	3 $\frac{5}{8}$ x 2 $\frac{1}{4}$	475 DP CHR	3 $\frac{1}{4}$

Bolt Size $\frac{1}{4}$ ".

Spare Saddle, Cat. No. 475 C00 99B.

Spare Base, Cat. No. 475 C00 99D.

Spare Thumb Bolt, Cat. No. 475 C00 99C.

Spare Liner with Lip and Tube, Cat. No. 483 DP1 BLK.



FISHING ROD HOLDER

FIG. 449

REMOVABLE

Chrome Plated Brass and Manganese Bronze
With Soft Black Liner.

Designed for Vertical Mounting, This Holder is Easily Removed
When Not in Use, Leaving No Projecting Hardware.



Fig. 449



ORDERING INFORMATION

I.D. Tube Inches	O.D. Tube Inches	Dimensions Bracket Inches	Display Pkg.- 1 pc. 1 Pc. per card	Weight Pounds
1 5/8	2	4 x 3 3/4	449 DP CHR	2 1/4

Screw Size #10.

Spare Holder Only, Cat. No. 449 000 99A.

Spare Bracket Only, Cat. No. 449 000 99B.

Spare Liner with Lip and Tube, Cat. No. 483 DP1 BLK.



CAP AND GASKET KITS FIGS. 480 & 481

Soft Black Flange Gasket with Integral Flip-up Cap and Soft Black Lip.
Replacement or Upgrade for Older Holders.



Fig. 480

ORDERING INFORMATION

To Fit Catalog Number	Display Pkg.-5 bags 1 Kit per bag	Weight Ounces
448 DP1 CHR	480 DP BLK	3
1205 DP CHR	480 DP BLK	3
452 DP STS	481 DP BLK	3



LINERS, LIPS AND TUBES

FIGS. 482 & 483

FOR FISHING ROD HOLDERS

Except Figs. 447, 1104 and 1215



Fig. 482

Fig. 483

ORDERING INFORMATION

I.D. Inches	For Flush Mount Complete Display Pkg. -5 bags 1 Set per bag	For All Others Complete Display Pkg. -5 bags 1 Set per bag	Spare Lip Only For Fig. 482 Display Pkg. -5 pcs. 1 Pc. per bag	Spare Lip Only For Fig. 483 Display Pkg. -5 pcs. 1 Pc. per bag
1 5/8	482 DP1 BLK	483 DP1 BLK	482 DP1 99A	483 DP1 99A
1 7/8	482 DP2 BLK	483 DP2 BLK	482 DP2 99A	483 DP2 99A



NUMERICAL INDEX

Fig. No.	Page No.	Fig. No.	Page No.	Fig. No.	Page No.	Fig. No.	Page No.	Fig. No.	Page No.
4D	44	124	111	223	72	309A	45	413	131
4F	31	125	13 & 16	226	18	309B	18	414	109
5D	44	126	97	230	36	310	77	415	182, 184 & 185
5F	31	127	90	231	36	311	104	420	90
06	33	128	65	233	142	313	51	423	182
7D	44	129	47	234	20	315	85	424	82
7F	31	131	31, 33 & 44	235	20	318	68	425	182
19	33	132	68	236	125	322	102	429	126
20	33	133	46	237	125	323	101	431	122
21	47	134	32 & 43	246	36	324	109	432	71
23	47	135	3, 6, 8 & 11	248	38	325	132	433	49 & 50
24	36	136	2	249	32, 43 & 48	328	104	434	126
52	36	137	69	250	28	329	28	435	49 & 50
60	179	138	36	255	78	330	88	440	49
62	179	139	4 & 7	256	38 & 48	334	89	441	92
63	106	140	69	257	66 & 67	335	89	444	186
65	107	141	65	258	150	336	89	445	184
66	107	142	102	259	38 & 48	337	37 & 84	447	189
67	37 & 84	144	90	260	38	339	85	448	189
69	37 & 84	148	144	261	38 & 48	340	37 & 84	449	192
70	37 & 84	149	150	263	110	342	48	450	72
71	37 & 84	150	90	265	71	344	127	451	186
72	37 & 84	152	150	266	110	347	48	452	189
74	38	153	90	268	38	348	103	454	46
75	102 & 103	155	147	269	38 & 48	349	92	455	19
76	106	157	4	271	155	350	103	460	187
82	145	158	91	272	155	351	127	461	92
86	107	159	91	276	36 & 45	357	112	465	90
91	30	160	120	278	38	358	135	468	187
92	30	162	92	280	71	360	145	469	187
98	30	163	83	281	38	362	18	470	185
99	30	164	83	283	38	363	110	471	187
102	33	165	83	284	38	365	101	474	186
105	77	166	90	285	101	366	77	475	191
106	38	170	22 to 24	286	36	371	18	476	187
107	3 & 6	171	90	289	38	373	44 & 48	477	20 & 133
108	18 & 29	172	90	290	36	374	37, 43 & 48	478	186
109	29	179	91	291	36	375	25 to 27 & 37	479	186
110	29	180	132	292	36	380	131	480	192
111	29	185	132	293	36	381	77	481	192
112A	45	196	83	294	44	395	180	482	192
112B	18	197	156	296	38	400	183	483	192
113	90	200	25 to 28	299	109	401	182 to 185	491	129
116	179	201	38	300	66	403	45	492	133
117	179	212	150	301	104	404	190	493	93
118	179	217	72	302	36	406	184 & 185	495	130
119	121	218	130	303	48	408	183	499	100
120	22 to 24 & 156	219	130	305	51	409	182 & 183	500	93
121	83	220	130	306	78	410	182 to 185	501	127
122	156	221	130	307	112	411	144	502	133
123	90	222	18 & 26	308	66	412	45	503	87

NUMERICAL INDEX

Fig. No.	Page No.	Fig. No.	Page No.	Fig. No.	Page No.	Fig. No.	Page No.	Fig. No.	Page No.
504	100	614	138	825	106	901	179	965	8
505	87	626	80	826	99	902	60	967	148
506	86	627	81	828	143	903	124	968	168
507	95	629	80	829	145	904	3	969	51 & 57
508	95	634	134	830	145	905	60 & 64	970	5
509	87	647	81	831	145	907	179	972	3
510	85	659	139	832	145	908	60	973	171
513	94 to 96	669	144	833	145	912	166 to 171	975	178
514	68 & 79	688	79	834	105	913	169	976	162, 167 & 168
515	87	694	80	835	105	915	6	977	162 & 163
517	79	697	148	836	58	918	169	978	162
518	86	701	78	837	58 & 63	919	169	980	163
520	96	703	78	839	58 & 63	920	167 to 171	982	47
521	96	704	108	840	63	921	163	983	163
524	95	705	108	841	174	922	163	984	167 to 170
526	100	708	92	842	140	924	157	985	47
527	96	709	108	844	58 & 63	925	173	986	162
528	94	714	111	845	58 & 63	926	173	987	154
530	115	719	177	846	58 & 63	927	171	988	154
531	79	720	82	847	63	928	170	991	167
532	79	721	108	848	63	929	168	992	167
533	140	722	108	851	51 & 55	930	170	994	179
534	49	732	136	852	51 & 57	931	164	995	167 & 168
535	49	737	111	859	63	932	164	996	179
537	99	741	123	860	58 & 63	934	177	997	179
538	49	742	111	863	126	935	177	998	157
539	100	750	123	866	64	937	177	999	154
544	115	752	122	869	179	938	172	1002	151
545	115	753	68	870	85	939	8	1003	151
546	120	754	136	872	58 & 63	940	8	1004	152
550	88	757	123	873	58 & 63	941	155	1016	176
554	161	759	124	874	58 & 63	942	155	1017	133
555	68	762	147	875	58	944	177	1021	172
558	79	769	148	876	58	945	8	1023	34
559	161	770	148	878	58	946	8	1024	165
561	86	773	153	879	58	947	158	1025	165
562	137	775	129	880	58 & 63	948	163	1026	34
565	134	776	175	881	137	949	152	1027	34
566	113	777	165	883	52 & 53	951	153	1028	170
567	166	786	81	884	54 & 55	952	153	1029	168
570	86	797	147	885	56 & 57	953	169	1030	170
571	86	805	105	889	60 & 64	954	176	1031	164
572	114	806	58 & 63	890	60 & 64	955	6	1032	164
573	118	807	58	891	60	956	159	1040	71
574	160	808	154	893	64	957	157	1041	140
575	174	809	58 & 63	894	64	958	176	1042	140
578	180	810	58 & 63	895	64	959	157 & 159	1043	127
608	122	811	58	896	179	960	171	1044	70
610	178	816	58	897	64	962	169 to 172	1045	5, 8, 15 & 34
612	139	817	58	898	179	963	6	1046	14 & 34
613	139	820	58	899	64	964	11	1047	5, 14 & 34

NUMERICAL INDEX

Fig. No.	Page No.	Fig. No.	Page No.	Fig. No.	Page No.	Fig. No.	Page No.	Fig. No.	Page No.
1050	127	1156	34	1224	132	1301	19	1714	188
1051	173	1158	4, 11 to 13	1226	135	1302	130	1715	188
1052	12, 19 & 35	1161	2	1227	141	1303	72	1798	188
1053	159	1164	41	1230	121	1305	116	1901	62 & 63
1054	12, 19 & 35	1165	41	1231	129	1306	118	1902	62 & 63
1056	172	1166	41	1232	174	1307	121	1921	63
1057	123	1167	41	1235	125	1308	121	1922	63
1059	16, 17 & 34	1168	41	1237	122	1309	138	1930	63
1060	5, 15, 17 & 34	1169	40	1238	88	1310	2	1931	63
1064	70	1170	40	1239	167	1311	17	1932	64
1065	161	1172	40	1240	167	1312	85	1933	64
1068	168	1173	40	1242	137	1313	98	1936	64
1087	65	1174	40	1243	136	1314	186	8501	74
1089	165	1175	112	1244	159	1315	117	8502	74
1090	65	1177	160	1246	138	1316	119	8503	74
1100	190	1178	11	1247	99	1320	186	8504	74
1101	162	1179	146	1248	99	1321	186	8505	76
1102	162	1180	146	1249	180	1323	67	8506	76
1103	174	1181	12	1250	122	1324	97	8603	76
1104	190	1183	12	1251	113	1325	127	9601	75
1105	40 to 42	1184	12	1252	113	1326	118	9602	75
1106	178	1185	142	1253	66	1329	98	9603	75
1107	190	1186	142	1254	69	1330	16	9604	75
1108	149	1187	142	1255	134	1331	11		
1109	36	1188	114	1256	135	1332	9		
1110	176	1189	82	1257	67	1336	128		
1111	46	1190	82	1258	67	1346	128		
1112	149	1191	82	1259	67	1399	98		
1113	149	1192	13	1260	67	1400	35		
1116	146	1194	158	1261	135	1405	116		
1117	146	1196	12	1262	141	1406	118		
1118	191	1197	12	1264	6	1410	2		
1119	40 to 42	1198	158	1267	141	1411	17		
1123	13 & 35	1199	160	1269	95	1413	97		
1124	13 & 35	1201	4	1270	97	1415	117		
1125	13	1205	189	1271	88	1416	119		
1127	32 & 43	1209	16	1279	169	1430	15		
1128	32 & 43	1210	114	1280	169	1600	35		
1129	32, 43 & 46	1211	5	1286	175	1601	7		
1130	32 & 43	1212	5	1287	160	1602	7		
1133	41	1213	154	1288	175	1603	4		
1134	19	1214	154	1289	139	1605	4		
1137	19	1215	191	1290	145	1606	4		
1143	40 & 41	1216	161	1291	145	1611	17		
1144	12 & 19	1217	161	1292	145	1612	5		
1150	42	1218	3	1293	152	1613	98		
1151	42	1219	122	1295	72	1629	98		
1152	42	1220	175	1296	5	1630	16		
1153	42	1221	175	1297	131	1631	15		
1154	42	1222	128	1298	131	1640	14		
1155	142	1223	120	1299	138	1660	14		

ALPHABETICAL INDEX

A	PAGE
Adapter —	
Pipe to Hose.....	106
Adjusters —	
Hatch.....	147
Windshield.....	145 & 146
All-Round Lights.....	12 to 20, 26, 27, 28, 29, 32, 34, 35, 40 to 43, 45 to 47
Anchor Chocks.....	124
Anchor Lights.....	12 to 20, 26, 27, 28, 29, 32, 34, 35, 40 to 43, 45 to 47
Assemblies, Control.....	51, 55, 57 & 63
Axe Brackets.....	132

B	PAGE
Bass Boat Lights.....	5
Bells —	
Fog.....	90 & 91
Smoke.....	65
Berth Lights.....	65 & 72
Bits.....	122
Boarding Steps.....	127
Bolts —	
Barrel.....	158 & 159
Cupboard.....	162
Ship.....	159
Book, Log.....	92
Bow —	
& Anchor Lights.....	12 & 13
Combination Lights.....	2 to 5, 22 to 26
Eyes.....	125
Brackets —	
Axe.....	132
Table.....	144
Breakdown Lights.....	40 to 45
Bulbs, Electric.....	37, 48, 58 & 84
Butt Hinges.....	151 to 157
Buttons —	
Door.....	161
Horn Push.....	78

C	PAGE
Cabin —	
Door Hooks.....	159 & 160
Lamps, Oil.....	65
Cabinet Hinges.....	154 to 157
Cable —	
Outlet.....	82
Straps.....	83
Caps, Gas Tank.....	97
Catches, Door.....	161, 162 & 172
Caulking Iron.....	112
Certification of Lights.....	1 & 39
Chain —	
Deck Pipe.....	123
Portlight.....	92

C - Contd.	PAGE
Chocks.....	120 & 121
Chocks, Anchor.....	124
Clam Shell Ventilators.....	85
Clamps —	
Hatch Hold-Down.....	149
Spring.....	20 & 133
Rope.....	135
Cleats.....	113 to 115 & 126
Clips —	
Line Support.....	83
Trolling.....	187
Coat & Hat Hooks.....	178
Cockpit Scupper.....	101 & 102
Combination —	
Bow & Anchor Lights.....	12 & 13
Side Lights.....	2 to 5, 22 to 26
Connections —	
Electric.....	82
Thru-Hull.....	102 to 105 & 108
Watertight, Deck.....	82
Connectors, Electric.....	82
Connectors, Garden Hose.....	100
Continuous Hinge.....	150
Control —	
Assemblies.....	51, 55, 57 & 63
Convertible Boat Top	
Fittings.....	180
Courtesy Lights.....	69 & 70
Cowl Ventilators.....	85
Cupboard —	
Bolts.....	162
Catches.....	161, 162 & 172
Turns.....	162
Curtain Fasteners.....	179

D	PAGE
Deck —	
Connection, Watertight.....	82
Lights.....	10 & 71
Pipes, Rope & Chain.....	122 & 123
Plate Keys.....	99
Plates.....	94 to 98 & 100
Dock Line Springs.....	124
Dome Lights.....	66 to 68
Door —	
Buttons.....	161
Catches.....	161, 162 & 172
Fasteners.....	148 & 149
Hinges.....	150 to 157
Holders.....	160 & 161
Hooks.....	159 & 160
Stops.....	160
Drain Plugs.....	109 to 111
Drawer —	
Knobs.....	173

ALPHABETICAL INDEX

D - Contd.	PAGE
Pulls	170 to 172
Dredging Light	46
Durade Ventilator	85

E	
Elbow Catches	172
Electric —	
Bulbs	37, 48, 58 & 84
Cabin Fixtures	65 to 72
Connections	82
Lamps	65 to 72
Sockets	34, 36, 48, 58, 59, 63 & 64
Switches	73 to 79
European Representative	IX
Eyes —	
Bow	125
Flange	125
Halyard	20
Lashing	125 & 126
Lifting	126
Transom	125

F	
Fasteners —	
Curtain	179
Door	148 & 149
Hatch	148 & 149
Table Leg	177
Fender —	
Hooks	138
Locks	138
Filler, Tank	94 to 98
Filters, Fuel	109
Filters, Water	93
Fishing —	
Pole Holders	189 to 192
Fittings —	
For Boat Top	179 & 180
For Rails	131 & 132
Waste	95
Fixtures, Light —	
Bulkhead, Oil	65
Bulkhead, Electric	65 & 72
Electric Cabin	65 to 72
Vapor Proof	65
Flag Pole —	
Sockets	130
Flag Staffs	130
Flange Eyes	125
Flush —	
Hatch Lifting Handles	165 & 175
Hatch Lifting Rings	173 & 174
Pulls	165, 167, 169, 173 to 176

F- Contd.	PAGE
Ring Catch	173
Fog Horn	92
Fuel —	
Filter	109
Separator	109
Strainer	109
Tank Filler	94 to 98
Fuse —	
Holder	79 to 81
Panels	79 to 81

G	
Gas —	
Strainer	109
Tank Caps	94 to 98
Tank Filler	94 to 98
Tank Vents	86 & 87
Globes	38, 48, 66 to 68
Grab Rail Posts	131
Grab Rails	129
Guides, Tiller Rope	135 & 136
Guides, Pole Line	187

H	
Halyard Eyes	20
Halyard Mount Lights	27
Handles —	
Flush Lifting	165 & 175
Sliding Window	176
Utility	128 & 129
Hasps	157 & 158
Hatch —	
Adjusters	147
Dog	165
Fasteners	148, 149 & 165
Hinges	150 to 157
Hold-Down Clamps	149
Lifting Handles	130, 131, 165 & 175
Lifting Rings	173 to 175
Trim	150
Support Braces	147
Hawse Hole Plate	122
Heights, Vertical Light	21
Hinges —	
Butt	151 to 157
Butterfly	157
Cabinet	154 to 157
Continuous	150
Cuddy Door	151 to 157
Hatch	151 to 157
Hatch Support	147
Non-Mortised	157
Piano	150
Pull Apart	150
Rail	132

ALPHABETICAL INDEX

H - Contd.	PAGE
Semi-Concealed	155
Shortside	154 to 156
Strap	156
"T"	156
Holders —	
Boat Hook	133
Door	160 & 161
Fishing Pole	189 to 192
Ring Buoy	133
Outrigger Pole	182 to 186
Hooks —	
Cabin Door	159 & 160
Coat & Hat	174
Fender	138
Lashing	178
Ski Towing	126
Snap	138 to 140
Utility	138, 174 & 176
Wardrobe	174
Horn Push Button	78
Horn, Fog	92
Horns, For Rowlocks	141 & 143
Hull Connections	102 to 105 & 108

I

Information —	
Certification of Navigation Lights	1 & 39
Electrical Standards	73
Light, Vertical Heights	21
Lock Bevels	166
Outrigger Pole Usage	181
PERKO, Story of	III & IV
Representatives	X & XI
Searchlight Bulb Data	58, 59 & 63
Sales Policy & Terms	V
Warranty	V & XII
Inlet —	
Fittings for Fresh Water	100
Strainer	107
Iron, Caulking	112

K

Keys, Deck Plate	99
Knobs, Drawer	173

L

Ladder Locks	144
Lamps —	
Cabin	65 to 72
Cabin, Oil	65
Wall	65 & 72
Lashing Eyes	125 & 126
Lashing Hooks	178
Latches	
Door	163 to 173

L - Contd.

PAGE

Flush	163 & 169
Mortise Latch Sets	167, 171 & 172
Rim Latch Sets	164, 166 to 170
Wood Rail	132
Leathers, Oar	142
Lenses	38, 48, 66 to 68
Lifting Eyes	126
Light Chart, Vertical Heights	21
Lights —	
All-Round	12 to 20, 26, 27, 28, 29, 32, 34, 35, 40 to 43, 45 to 47
Anchor	12 to 20, 26, 27, 28, 29, 32, 34, 35, 40 to 43, 45 to 47
Bass Boat	5
Berth	65 & 72
Bi-Color	2 to 6, 22 to 26
Breakdown	40 to 45
Combination	2 to 5, 12, 13, 22 to 28
Courtesy	69 & 70
Deck	10, 22 & 71
Dredging Light	46
Dome	66 to 68
For Windshield	12 & 13
Mounting	4, 10 to 12, 19, 22 to 24, 26, 28, 29, 32, 40 to 45
Mast	10 to 13, 22 to 26, 28 to 33, 40 to 45 & 47
Masthead	28 to 33, 40 to 45 & 47
Meal & Absent	28
Not Under-Command	40 to 45
Pole	5, 8, 12 to 17 & 19
Range	40 to 45
Searchlights	49 to 63
Side	6, 7, 22 to 26, 29 to 33, 40 to 45 & 47
Signal	29 to 34, 40 to 45 & 47
Spreader	71
Stern	8, 9, 22 to 26, 29 to 33, 40 to 45 & 47
Towing	25, 26, 29 to 33, 40 to 45 & 47
Utility	69 & 70
Vapor-Proof	65
Line Support Clips	83
Locks —	
Doors	165 to 171
Fender	138
Flush	163 & 164
Ladder	144
Mortise	171
Rim	169
Window	173
Log Book	92
Locker Ventilators	88
Louver Ventilators	89

ALPHABETICAL INDEX

M	PAGE
Mast Lights	4, 10 to 12, 19, 22 to 24, 26, 28, 29, 32, 40 to 45
Masthead Lights.....	10 to 13, 22 to 26, 28 to 33, 40 to 45 & 47
Meal and Absent Light	28
Mooring Bitts	122

N	PAGE
Navigation Lights —	
For Vessels:	
Under 20 Meters (65.6 ft.) In Length	1 to 34
Over 20 Meters (65.6 ft) In Length	39 to 47

O	PAGE
Oar —	
Leather and Buttons	142
Locks	141 to 143
Outboard Motor	
Transom Plates	132
Outlets —	
Cable	82
Water	100
Outrigger —	
Holders	181 to 186
Kit	187
Pole Line Guides	187
Poles	187 & 188
Spreaders	188
Trolling Pins	187

P	PAGE
Paint Scraper	112
Palm, Sewing	144
Panels —	
Fuse	79 to 81
Switch	79
Piano Hinge	150
Pin, Trolling	187
Pipes, Rope Deck	122 & 123
Plates —	
Deck	94 to 98 & 100
Hawse Hole	122
Step	127
Transom	132
Plugs, Drain	109 to 111
Pole Holders —	
Fishing	189 to 192
Outrigger	181 to 186
Pole Light —	
Replacement Bases	34 & 35
Replacement Poles	35
Vertical Height Chart	21
Pole Lights	5, 8, 12 to 17 & 19
Pole Sockets, Flag	130

P - Contd.	PAGE
Poles —	
Flag	130
Outrigger	187 & 188
Posts —	
Grab Rail	131
Stanchion	131
Pulleys	136
Pulls —	
Drawer	173 to 176
Flush	165, 167, 169, 173 to 176
Pump Strainers	108

R	PAGE
Rail —	
Fittings	131 & 132
Hinges And Latches	132 & 150
Rails, Grab	129
Range Lights	40 to 45
Representatives	X & XI
Rigging Tube.....	357
Rim Locks	169
Rim Latches.....	164, 166 to 170
Ring —	
Buoy Holders	133
Catches, Flush	173
Pulls	165, 173 to 175
Rings, Hatch Lifting	174 & 175
Roller Tip Line Guide	187
Rope —	
Clamps	135
Guides	135 & 136
Pulleys	134
Rope Tighteners	136
Rowlocks	141 to 143

S	PAGE
Safety Cable	99
Scraper	112
Scuppers —	
Cockpit	101 & 102
Thru-Hull	101
Valve Assembly	101
Seacocks	105
Searchlight —	
Bulbs	58, 59 & 63
Control Assemblies	51, 55, 57 & 63
Spare Parts	58, 60, 63 & 64
Searchlights	49 to 63
Separator, Fuel	109
Shield, For Pole or Mast Lights.....	13
Side Lights	6 & 7, 22 to 26, 29 to 33, 40 to 45 & 47
Signal Lights, Portable or Fixed	29 to 34, 40 to 45 & 47

ALPHABETICAL INDEX

S - Contd.	PAGE
Ski Towing Hook.....	126
Smoke Bell & Arm	65
Snap Hooks	138 to 140
Sockets —	
Boat Cover	180
Electric	34, 36, 48, 58 59, 63 & 64
Fishing Rod	189 to 192
Flag Pole.....	130
Rowlock	141 to 143
Searchlight	58, 59, 63 & 64
Spreaders For Outrigger Poles	188
Spreader Lights	71
Spring Clamps	20 & 133
Springs For Dock Line	124
Spring, Tiller Rope	136
Staffs, Flag	130
Steps —	
Boarding	127
Folding	127
Step Plates	127
Stern —	
Lights	8, 9, 22 to 26, 29 to 33 40 to 45 & 47
Pole Lights	8, 14 to 17
Stops —	
Door	160
Window	177
Strainers —	
Fuel	109
Gasoline	109
Thru-Hull	107
Inlet	93 & 107
Pump	108
Water	93
Strap Hinges	156
Straps, Cable	83
Switch Panels.....	79
Switches —	
Battery	74 to 76
Electric	74 to 79
Master.....	75
Panel	79
Swivel —	
Eye Pulleys	134
Eye Snaps	139 & 140
T	
"T" Hinges	156
Table Brackets	144
Table Leg Fasteners	177
Terminal Blocks.....	81
Thru Hull Connections.....	102 to 105 & 108

T - Contd.	PAGE
Tiller —	
Rope Clamps	135
Rope Guides	135 & 136
Rope Pulleys	134
Rope Tighteners	136
Towing Hooks	126
Towing Lights	25, 26, 29 to 33, 40 to 45 & 47
Transom —	
Eyes	125
Plates	132
Stern Lights	8
Ventilators.....	88
Trim, Hatch	150
Trolling Pin	187
Tube, Rigging.....	112
Tri-Color Lights.....	4, 26 & 28
Turns, Cupboard	162
U	
Universal Replacement Pole Light	35
Utility Hooks	138, 174 & 176
Utility Lights	69 & 70
V	
Vapor Proof Fixtures	65
Ventilator —	
Cowl	85
Durade	85
Gas Tank	86 & 87
Locker	88
Louver	89
Clam Shell Type	85
Transom.....	88
W	
Wardrobe Hooks	178
Warranty Information	V & XII
Waste Fitting	95
Water Strainers	93
Whistle	92
Window —	
Anti-Rattler	177
Handle, Sliding	176
Lock	177
Stop	177
Windshield —	
Adjusters	145 & 146
Keeper & Plate	147 & 148
Pole Lights for	12 & 13
Wiper	142

PERKO®

WE MAKE IT RIGHT. RIGHT HERE

Street Address
16490 Northwest 13th Avenue
Miami, Florida 33169-5707

Mailing Address
P.O. Box 64000D
Miami, Florida 33164-0510

Telephone Number
(305) 621-7525

Fax Number
(305) 620-9978

**WE ARE MEMBERS OF THE FOLLOWING
MARINE ASSOCIATIONS**



NATIONAL MARINE
MANUFACTURERS ASSOCIATION



AMERICAN BOAT AND YACHT COUNCIL, INC.
CHARTER MEMBER



THE PROPELLER CLUB OF THE
UNITED STATES



MARINE RETAILERS ASSOCIATION
OF AMERICA

**THE DIFFERENCE®
IS DISTINCTIVE**

